

# STRAIGHT EDGE™ PRO

## LED Cabinet and Niche Lighting LS-LED

# WAC

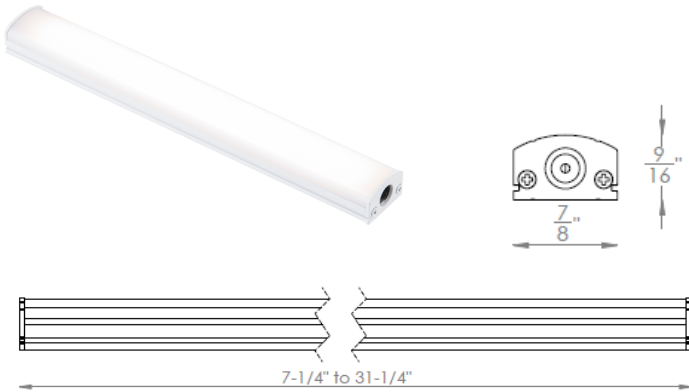

Fixture Type:

Catalog Number:

Project:

Location:

### PRODUCT DESCRIPTION

Low power consumption and strong lumen output make this low-profile LED strip light system perfect for small coves and niches, cabinets, shelves and bookcases.

### FEATURES

- Available in 5 lengths
- Multiple connectors and cables available to facilitate custom layouts
- Four mounting options provided for different surfaces
- Each section includes 2 flat mounting clips, 2 45° angle mounting clips and 1 "I" connector
- Adjustable angle mounting clips allow fixture to be easily aimed while securely mounted for optimal task lighting performance and flexibility
- 120° beam spread
- Free of projected heat, UV and IR radiation
- 70,000 hour rated life
- 5 year WAC Lighting product warranty
- Frosted Lens, no LED hotspot

### SPECIFICATIONS

**Construction:** Extruded aluminum body with a polycarbonate diffused lens.

**Power Supply:** Remote and plug-in electronic Class 2 transformers. 120VAC and 277VDC 50/60Hz input, 24V 60W and 96W output.

**Light Source:** Integrated LED in 2700K, 3000K, and 3500K

**Dimming:** May be dimmed to 1% with electronic low voltage (ELV) dimmer.

**Finish:** Abrasion resistant White (WT) powder coat finish.

**Standards:** UL & CUL Listed for use in damp locations.

### ORDER NUMBER

Model #	Length	Color Temp	Finish
LS-LED08P	7¼"	27 2700K	WT White
LS-LED14P	13¾"		
LS-LED20P	19¼"	30 3000K	
LS-LED26P	25¼"	35 3500K	
LS-LED32P	31¼"		



Example: LS-LED14P-30-WT

### FIXTURE PERFORMANCE

Model #	Color Temp	Power	Lumens	Efficacy	CRI
LS-LED08P-27	2700K	2.6W	180	69 Lm/W	90
LS-LED14P-27	2700K	4.7W	335	71 Lm/W	90
LS-LED20P-27	2700K	7.4W	520	70 Lm/W	90
LS-LED26P-27	2700K	9.5W	670	71 Lm/W	90
LS-LED32P-27	2700K	12.0W	850	71 Lm/W	90
LS-LED08P-30	3000K	2.6W	185	71 Lm/W	90
LS-LED14P-30	3000K	4.7W	345	73 Lm/W	90
LS-LED20P-30	3000K	7.4W	535	72 Lm/W	90
LS-LED26P-30	3000K	9.5W	695	73 Lm/W	90
LS-LED32P-30	3000K	12.0W	880	73 Lm/W	90
LS-LED08P-35	3500K	2.6W	190	73 Lm/W	90
LS-LED14P-35	3000K	4.7W	355	76 Lm/W	90
LS-LED20P-35	3500K	7.4W	555	75 Lm/W	90
LS-LED26P-35	3500K	9.5W	720	76 Lm/W	90
LS-LED32P-35	3500K	12.0W	910	76 Lm/W	90

### MAX RUN

Model #	60W Transformer	96W Transformer
LS-LED08P	20 pieces	36 pieces
LS-LED14P	12 pieces	20 pieces
LS-LED20P	8 pieces	13 pieces
LS-LED26P	6 pieces	10 pieces
LS-LED32P	5 pieces	8 pieces

### POWER SUPPLIES

Plug-in

EN-2460-P-AR-S	120VAC/60W Class 2 LED transformer
EN-24100-P-AR-S	120VAC/96W Class 2 LED transformer

Remote (Hard-Wired)

EN-2460-RB2-S	120VAC/60W Class 2 LED transformer
EN-24100-RB2-S	120VAC/96W Class 2 LED transformer
EN-24100-277-RB2-T	277VDC/96W Class 2 LED transformer

### POWER SUPPLY ACCESSORIES

TB-S	Wiring box with switch
MTB	Multiple terminal block
SL-EXT-144	12' extension cable
SL-WC-1	Wire Clip

For full descriptions and specs of Power Supplies and all Accessories see next pages.

wacighting.com  
Phone (800) 526.2588  
Fax (800) 526.2585

Headquarters/Eastern Distribution Center  
44 Harbor Park Drive  
Port Washington, NY 11050

Central Distribution Center  
1600 Distribution Ct  
Lithia Springs, GA 30122



Western Distribution Center  
1750 Archibald Avenue  
Ontario, CA 91760

# STRAIGHT EDGE™ PRO





## LED Cabinet and Niche Lighting LS-LED



### POWER SUPPLIES

			Input	Output		
120V AC Plug-in Class 2 Transformer		<b>EN-2460-P-AR-S</b> <b>EN-24100-P-AR-S</b>	120V 120V	24V/60W 24V/96W	2¾" × 1⅝" × 1¾" 4⅝" × 2" × 1⅝"	May be dimmed. Includes 6' cord and five SL-WC-1 plastic wire clips.
120V AC Remote Class 2 Transformer		<b>EN-2460-RB2-S</b> <b>EN-24100-RB2-S</b>	120V 120V	24V/60W 24V/96W	6½" × 1⅝" × 1¼"	May be dimmed. Includes 6' cord and five SL-WC-1 plastic wire clips.
120-277V DC Remote Class 2 Power Supply		<b>EN-24100-277-RB2-T</b>	120- 277V	24V/96W	12⅝" × 3¼" × 2"	May be 0-10V dimmed. Includes 6' cord and Straight Edge connector.

### POWER SUPPLY ACCESSORIES





Wiring box with switch		<b>TB-S</b>		6¼" × 1⅝" × 1¼"	Use when spanning a large gap in a system layout without leaving exposed wiring (ie: lighting kitchen cabinets on both sides of a sink or window). Low voltage wiring is collected inside box, with Romex® wire output to go behind a wall.
Multiple Terminal Block		<b>MTB-06</b> 6 outputs <b>MTB-08</b> 8 outputs		4⅞" × 1⅝" × ¾" 4⅞" × 1⅝" × ¾"	Easily wire multiple output connections for a neat installation without the use of open splices. One power supply input and either 6 or 8 outputs. 5A capacity. Three mounting screws included.
12' Extension Cable		<b>SL-EXT-144</b>		Wire: 144" Connector: 1⅝"	Use to extend the distance between power supply or wiring box (TB-S) to a Straight Edge™ section.
Wire Clip (10 Pack)		<b>SL-WC-1</b>		½" × ⅜"	Use to tack power cords or joiner cables neatly to a surface.

# STRAIGHT EDGE™ PRO



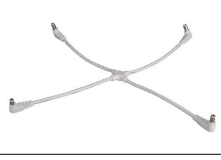

## LED Cabinet and Niche Lighting LS-LED



### CONNECTION ACCESSORIES

"I" Connector		<b>SL-I</b>	Ø¼" × 7⁄8"	For end-to-end connection of Straight Edge™ sections. (One included with each Straight edge™ section).
Joiner Cables		<b>SL-IC-06</b> <b>SL-IC-12</b> <b>SL-IC-24</b> <b>SL-IC-36</b>	6" 12" 24" 36"	Connects two sections of Straight Edge™.
Custom Cable Extenders		<b>SL-IF</b>	Ø³⁄⁸" × 3⁄⁸"	Two female ends. Connects two joiner cables to create custom lengths.
4-way "X" connector		<b>SL-X</b>	Wires: 4" each Connectors: 1½" each	"X" connector has four male connectors and can be used to easily customize your design layout.
3-way "Y" connector		<b>SL-Y</b>	Wires: 4" each Connectors: 1½" each	"Y" connector has three male connectors and can be used to easily customize your design layout.

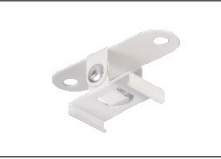
### MOUNTING ACCESSORIES

Flat Mounting Clip		<b>SL-C1-WT</b>	1" × ½" × 1¼"	Metal clip used to mount Straight Edge™ sections flat to a surface. (Two included with each Straight Edge™ section).
45° Angle Mounting Clip		<b>SL-C2-WT</b>	1" × 1" × 1½"	Metal clip used to mount Straight Edge™ sections in corners. (Two included with each Straight Edge™ section).
Adjustable Angle Mounting Clip		<b>SL-C3-WT</b>	5⁄8" × 5⁄8" × 1¾"	Metal clip used to mount Straight Edge™ sections at variable angles.
Magnetic Tape		<b>MAG-TAPE-36</b>	36" × ¾"	One magnetic side and one peel and stick side for mounting Straight Edge™ sections to a metal surface. Easily cut in field.