

INSTALLATION INSTRUCTION

1901- Vega Wall Sconce

WS-W190109/WS-W190114

WAC LIMITED

CAUTION: To prevent electrical shock, ensure electricity has been turned off at the circuit breaker before beginning.

- Read all instructions before installing.
- Fixture is intended for installation by a licensed electrician in accordance with the National Electrical Code (NEC) and local regulations.
- When handling the fixture, do not apply pressure to the LEDs.
- Retain installation instructions for future maintenance reference.

WARNING: All parts must be used as indicated in these instructions. This product is designed for use only with the supplied parts and/or accessories designated for use by WAC Lighting. Substitution of parts or accessories not designated for use with this product by WAC Lighting could result in personal injury or property damage, and will void the warranty. Contact an authorized dealer or the manufacturer if any parts are damaged or missing.

MAINTENANCE NOTE: Coastal conditions may cause mineral and residue build-up on the fixture. We recommend that customers in coastal areas clean all external surfaces of the fixture once every two weeks with a wet cloth.













MISE EN GARDE: Pour éviter tout choc électrique, assurez-vous que le disjoncteur soit mis hors tension avant de commencer.

- Lisez toutes les instructions avant l'installation.
- Le système doit être installé par un électricien licencié conformément au code national de l'électricité (NEC), et également aux règlements locaux.
- Lors de la manipulation du luminaire, n'appuyez pas sur les LED. Tenez-le uniquement par la base.

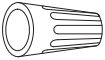
ATTENTION: Toutes les pièces doivent être utilisées comme indiqué dans ces instructions. Ce produit est conçu pour être utilisé seulement avec les pièces et/ou accessoires fournis pour être utilisés avec les produits WAC Lighting. Remplacer des pièces ou accessoires non conçus pour ce produit WAC Lighting pourrait causer des dommages corporels ou matériels et pourrait également causer l'annulation de la garantie. Veuillez contacter un revendeur autorisé ou le fabricant si des pièces manquent ou sont endommagées.

NOTE D'ENTRETIEN: Les conditions côtières peut causer une accumulation de minéraux et de résidus sur le luminaire. Nous recommandons aux clients qui résident dans les zones côtières de nettoyer toutes les surfaces externes du luminaire une fois toutes les deux semaines avec un chiffon humide.

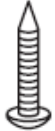
HARDWARE

				WS-W190114 only	WS-W190114 only
					
					
Wire Connector Qty: 3pcs+1 Extra	Mounting Screw Qty: 1 Extra	Rubber Gasket Qty: 1 Extra	Junction Box Screw Qty: 2pcs + 1 Extra	Wood Screw Qty: 2pcs + 1 Extra	Plastic Anchor Qty: 2pcs + 1 Extra

waclighting.com
Phone (800) 526.2588
Fax (800) 526.2585

Headquarters/Eastern Distribution Center
44 Harbor Park Drive
Port Washington, NY 11050

Central Distribution Center
1600 Distribution Ct
Lithia Springs, GA 30122

Western Distribution Center
1750 Archibald Avenue
Ontario, CA 91760



Fig.1

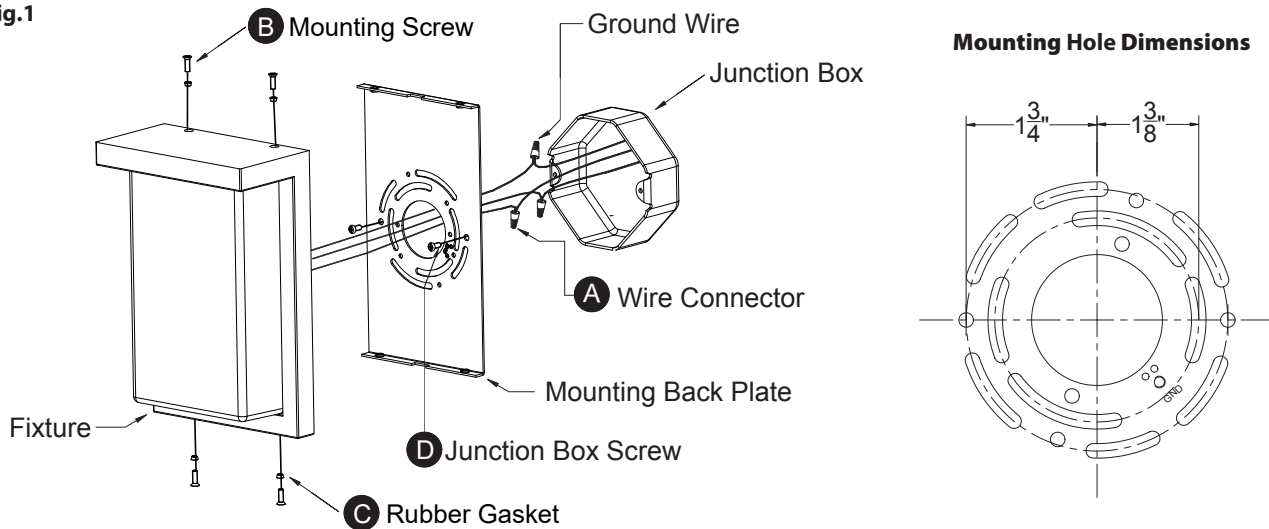

PREPARATION

1. Shut off the power at the circuit breaker and remove existing fixture, including the crossbar.
2. Carefully unpack your new fixture and lay out all the parts on a clear area. Be careful not to lose any small parts necessary for installation.

MOUNTING THE FIXTURE (Fig. 1)

3. Remove the mounting screw (B) from the fixture.
4. Secure the mounting back plate to the junction box using the screws (D) provided.
NOTE: The side of the mounting plate marked "GND" must face out.
5. For WS-190114, further secure your mounting back plate to the mounting surface using the wood screws (E) and Plastic Anchors (F) provided at the additional keyholes in the mounting plate (Fig. 2).

Fig.2 (WS-190114 only)



CONNECTING THE WIRES (Fig. 2)

5. Connect the fixture's input wires to junction box wires as shown (Fig. 3). Make sure that all wire connectors (A) are secure. If your outlet box has a green or bare copper ground wire, connect the fixture's ground wire to it. Otherwise, connect the fixture's ground wire directly to the back plate using the green screw provided. After wires are connected, tuck them carefully inside the junction box.

COMPLETING THE INSTALLATION

6. Secure the fixture to the mounting back plate using the mounting screw (B) and Rubber gasket(C).
7. To prevent moisture from entering the outlet box and causing a short, use clear caulking (i.e. indoor/outdoor silicone sealant) to outline the outside of fixture (Fig.4)

Fig.3 Wiring

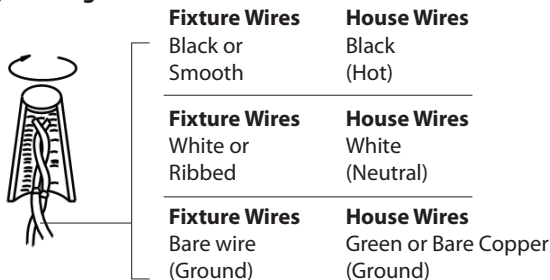

Fig.4

