

INSTALLATION INSTRUCTION

Cube Architectural - LED Wall Mount

DC-WS05, DC-WS06, DC-WD05, DC-WD06

WAC LIGHTING

Responsible Lighting®

WARNING

IMPORTANT: NEVER attempt any work without shutting off the electricity.

- Read all instructions before installing.
- System is intended for installation by a qualified electrician in accordance with the National Electrical Code and local regulations.
- Go to the main fuse box, or circuit breaker. Place the main power switch in the "OFF" position and unscrew the fuse(s) or switch "OFF" the circuit breaker switch(es) that control the power to the fixture or room that you are working on.
- Place the wall switch in the "OFF" position.

CAUTION

- All parts must be used as indicated in these instructions. Do not substitute any parts, leave parts out, or use any parts that are worn out or broken. Failure to follow this instruction could invalidate the ETL/CETL listing of this fixture.
CAUTION When handling the fixture, do not apply pressure to the LEDs. Hold the fixture by the base only.

AVERTISSEMENT

IMPORTANT : Coupez l'électricité avant TOUTE manipulation.

- Lisez toutes les instructions avant d'installer.
- Système est destiné à être installé par un électricien qualifié en conformité avec le code national de l'électricité et les règlements locaux.
- Accédez au panneau central de disjoncteurs ou de fusibles de votre demeure et placez l'interrupteur principal en position d'arrêt (« OFF »).
- Placez l'interrupteur mural en position d'arrêt (« OFF »).

MISE EN GARDE

- Toutes les pièces doivent être utilisées tel qu'il est indiqué dans ces instructions. Ne remplacez pas les pièces, n'en laissez pas de côté et ne les utilisez pas si elles sont usées ou brisées. Le non-respect de ces instructions peut annuler l'homologation ETL/CETL du luminaire. MISE EN GARDE Ors de la manipulation de l'appareil, ne pas appliquer de pression à la LED, tenir l'appareil par la seule base.

ADVERTENCIA

IMPORTANTE: NUNCA intente hacer trabajos sin desconectar el suministro eléctrico.

- Lea y comprenda todas las instrucciones e ilustraciones por completo antes de proceder con el ensamblaje e instalación de esta lámpara.
- Sistema está diseñado para ser instalado por un electricista calificado, de acuerdo con el código eléctrico nacional y las normas locales.
- Diríjase a la caja de fusibles o a la caja del interruptor de circuito principal en su hogar. Coloque el interruptor de alimentación principal en la posición "OFF" (APAGADO).
- Coloque el interruptor de la pared en la posición "OFF" (APAGADO).

PRECAUCIÓN

- Todas las piezas deben usarse como lo indican estas instrucciones. No reemplace las piezas, no omita piezas durante la instalación ni utilice piezas gastadas o rotas. El incumplimiento de esta indicación podría invalidar la calificación ETL/CETL esta lámpara. PRECAUCIÓN Al manipular el aparato, no aplique presión a los LED, mantenga el aparato en la base sólo.

HARDWARE

FIG.1

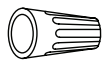

Wire Connector
Qty: 5pcs
7EAC112201



Junction Box Screw
Qty: 3pcs
7MPF0825F1



Gasket

Qty: 2pcs (5") Qty: 2pcs (6")
WT: 7TGD070101WT WT: 7TGD080101WT
BK: 7TGD070101BK BK: 7TGD080101BK
BZ: 7TGD070101BZ BZ: 7TGD080101BZ
GH: 7TGD070101GH GH: 7TGD080101GH

wacighting.com
Phone (800) 526.2588
Fax (800) 526.2585

Headquarters/Eastern Distribution Center
44 Harbor Park Drive
Port Washington, NY 11050

Central Distribution Center
1600 Distribution Ct
Lithia Springs, GA 30122

Western Distribution Center
1750 Archibald Avenue
Ontario, CA 91760

INSTALLATION INSTRUCTION

Cube Architectural - LED Wall Mount

DC-WS05, DC-WS06, DC-WD05, DC-WD06

WAC LIGHTING

Responsible Lighting®

OVERVIEW

It is surface mount down light, included ceiling mount, pendant mount, single direction wall wash and up-down direction wall wash. Check catalog for various mount type, size, beam angle and color choices.

FIXTURE INSTALLATION

1. Carefully unpack your new fixture and lay out all the parts on a clear area. Be carefully not to lose any small parts necessary for installation. (See **FIG.1**)
2. Remove the screw holding mounting plate to fixture, and remove mounting plate from fixture. (See **FIG.2**)
3. Secure mounting plate to the junction box in wall provided by others. (See **FIG.2**)
4. Pull power supply wires out of junction box through mounting plate. Connect black fixture wire to hot wire, white fixture wire to neutral wire and green fixture wire to ground. This fixture offers 0-10V dimming capability. To utilize, connect purple fixture wire to hot dimming wire and gray fixture wire to neutral dimming wire. If not utilizing dimming, terminate the dimming wires by capping them separately. After wires are connected securely, tuck them carefully inside the junction box. (See **FIG.2**)
5. Put the fixture to the mounting plate, and secure with screws and gasket. (See **FIG.2**)

FIG.2

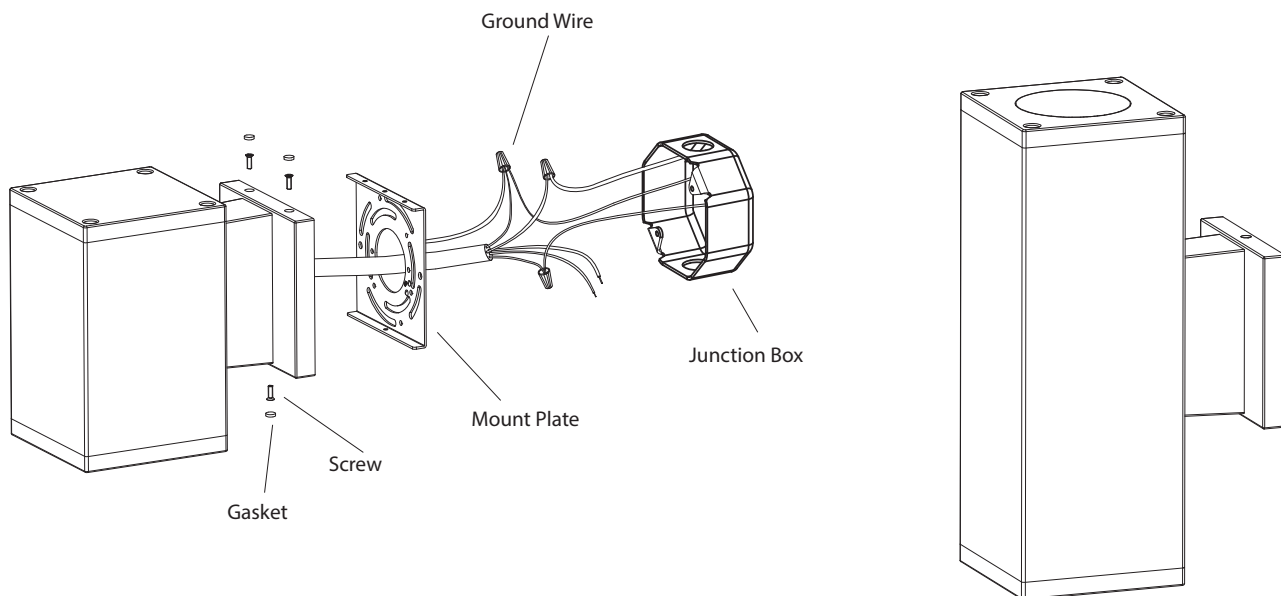

wacighting.com
Phone (800) 526.2588
Fax (800) 526.2585

Headquarters/Eastern Distribution Center
44 Harbor Park Drive
Port Washington, NY 11050

Central Distribution Center
1600 Distribution Ct
Lithia Springs, GA 30122

Western Distribution Center
1750 Archibald Avenue
Ontario, CA 91760

INSTALLATION INSTRUCTION

Cube Architectural - LED Wall Mount

DC-WS05, DC-WS06, DC-WD05, DC-WD06

WAC LIGHTING

Responsible Lighting®

REFLECTOR REPLACEMENT

1. Remove panel assembly by loosening the fixture screw and gasket, remove four chips to change reflector. (**FIG.3**)
2. Replace your beam angle reflector on panel and fix the clips. (**FIG.4**)

FIG.3 Remove four clips

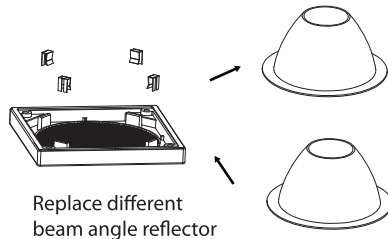
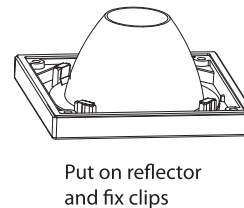

FIG.4



LED REPLACEMENT

1. Loosen the screw and gasket (See **FIG.5**), remove the panel assembly (See **FIG.6**).
2. Loosen the LED screws and LED holder, carefully disconnect LED quick connector then replace LED. (See **FIG.7**).

FIG.5 Loosen the fixture screws and gaskets



FIG.6 Remove panel assembly

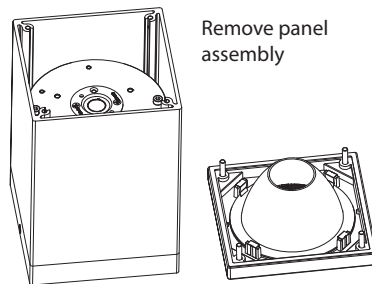
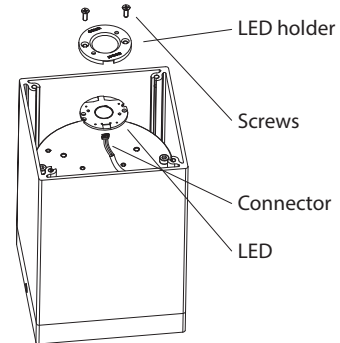

FIG.7 LED holder, Screws, Connector, LED



DRIVER REPLACEMENT

1. Loosen the screw and gasket (See **FIG.8**), remove the cover assembly (See **FIG.9**).
2. Loosen the LED driver screws, carefully disconnect LED driver connector from LED connector and replace driver by removing driver mounting screws. (See **FIG.10**).

FIG.8 Loosen the fixture screws and gaskets

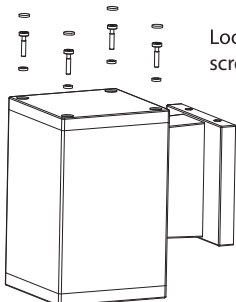

FIG.9 Remove panel assembly

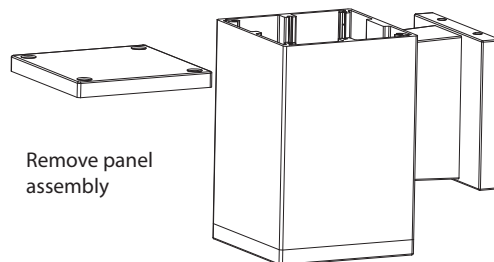
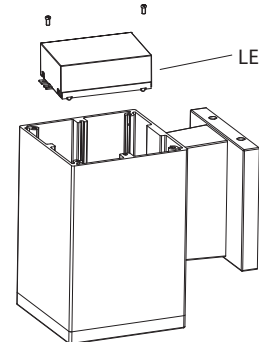

FIG.10 LED holder



COMPLETING THE INSTALLATION

To prevent moisture from entering the outlet box and causing a short, use clear caulking (i.e. indoor/outdoor silicone sealant) to outline the outside of fixture plate where it meets the wall leaving a space at bottom to allow moisture a means to escape.

wacighting.com
Phone (800) 526.2588
Fax (800) 526.2585

Headquarters/Eastern Distribution Center
44 Harbor Park Drive
Port Washington, NY 11050

Central Distribution Center
1600 Distribution Ct
Lithia Springs, GA 30122

Western Distribution Center
1750 Archibald Avenue
Ontario, CA 91760