

# INSTALLATION INSTRUCTION

## Landscape 12V Outdoor Tape

8011/8051/8101

WAC LIGHTING  
Responsible Lighting®

### SAFETY INSTRUCTION

IMPORTANT: NEVER attempt any work without shutting off the electricity.

- Read all instructions before installing.
- System is intended for installation by a qualified electrician in accordance with the National Electrical Code and local regulations.
- Place the wall switch in the "OFF" position.
- Go to the main fuse box, or circuit breaker. Unscrew the fuse(s) or switch "OFF" the circuit breaker switch(es) that control the power to the space that you are working on.

### CAUTION:

All parts must be used as indicated in these instructions. Do not substitute any parts, leave parts out, or use any parts that are worn out or broken. Failure to follow this instruction could invalidate the ETL/cETL listing of this fixture.

### AVERTISSEMENT

#### IMPORTANT : COUPEZ L'ÉLECTRICITÉ AVANT TOUTE MANIPULATION.

- Lisez toutes les instructions avant d'installer.
- Système est destiné à être installé par un électricien qualifié en conformité avec le code national de l'électricité et les règlements locaux.
- Placez l'interrupteur mural en position d'arrêt (« OFF »).
- Accédez au panneau central de disjoncteurs ou de fusibles de votre demeure et placez l'interrupteur principal en position d'arrêt (« OFF »).

### MISE EN GARDE

Toutes les pièces doivent être utilisées tel qu'il est indiqué dans ces instructions. Ne remplacez pas les pièces, n'en laissez pas de côté et ne les utilisez pas si elles sont usées ou brisées. Le non-respect de ces instructions peut annuler l'homologation ETL/cETL du luminaire.

### THIS INSTRUCTIONS APPLY TO THE MODELS BELOW:

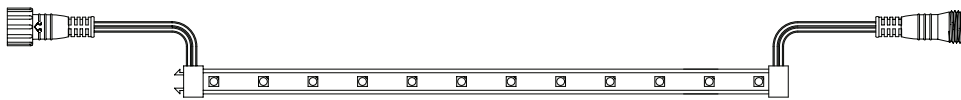

8011  
8051  
8101

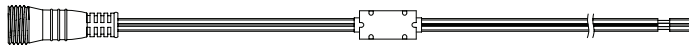

8000

waclighting.com

Phone (800) 526.2588

Fax (800) 526.2585

Headquarters/Eastern Distribution Center

44 Harbor Park Drive

Port Washington, NY 11050

Central Distribution Center

1600 Distribution Ct

Lithia Springs, GA 30122

Western Distribution Center

1750 Archibald Avenue

Ontario, CA 91760

# INSTALLATION INSTRUCTION

## Landscape 12V Outdoor Tape

8011/8051/8101

**WAC LIGHTING**  
Responsible Lighting®

### LANDSCAPE 12V OUTDOOR

- Determine the installation area and material, based on different mounting materials (wood or concrete), different mounting accessories will be needed.

### WIRING AND INSTALLATION:

Please refer to installation diagrams shown on next page.

- Determine the number of separately powered runs needed. Calculate the number of power supplies.

Min. / max. tape run length	1ft / 40ft per run
Current	180 mA/ft
Power consumption	2 Watts/ft
Input	9-15V AC
Fuse amperage	5A

- Measure the length of each run and round it off to the nearest 1 foot interval.  
Determine the necessary quantities of 1ft, 5ft, and 10ft sections, joiner cables and X or Y connectors.  
*Note: Tape light may be field cut every 1 inch at end of run.*
- Connect external power supply to lead wire in accordance to power supply specifications.
- Connect output female connector of the lead wire with the male connector of the landscape 12V outdoor tape or connector.
- Male/Female connectors of each InvisiLED component can be connected together to form a run.
- Terminate each separately powered run with an end cap. Install the end cap with silicon ensuring watertight seal.

Tape section:

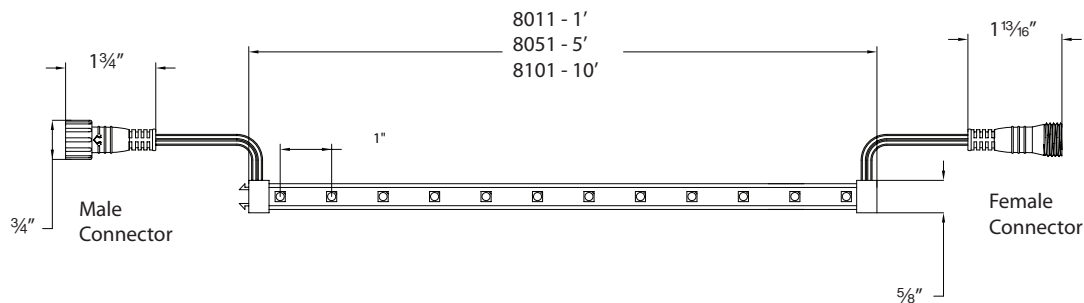

Lead wire with fuse:

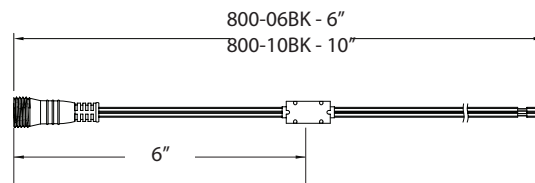

**wacighting.com**  
Phone (800) 526.2588  
Fax (800) 526.2585

**Headquarters/Eastern Distribution Center**  
44 Harbor Park Drive  
Port Washington, NY 11050

**Central Distribution Center**  
1600 Distribution Ct  
Lithia Springs, GA 30122

**Western Distribution Center**  
1750 Archibald Avenue  
Ontario, CA 91760

**INSTALLATION INSTRUCTION**  
**Landscape 12V Outdoor Tape**

8011/8051/8101

**WAC LIGHTING**

Responsible Lighting®

**SAMPLE LAYOUT**

A	External Power Supply
B 8000-06/10	6 or 10 ft lead wire with fuse
C 8011/8051/8101	1, 5, or 10ft tape section
D 8003	X Connector
E 8002	Y Connector
F LED-TO24-EC	End Cap

**HARD WIRE**

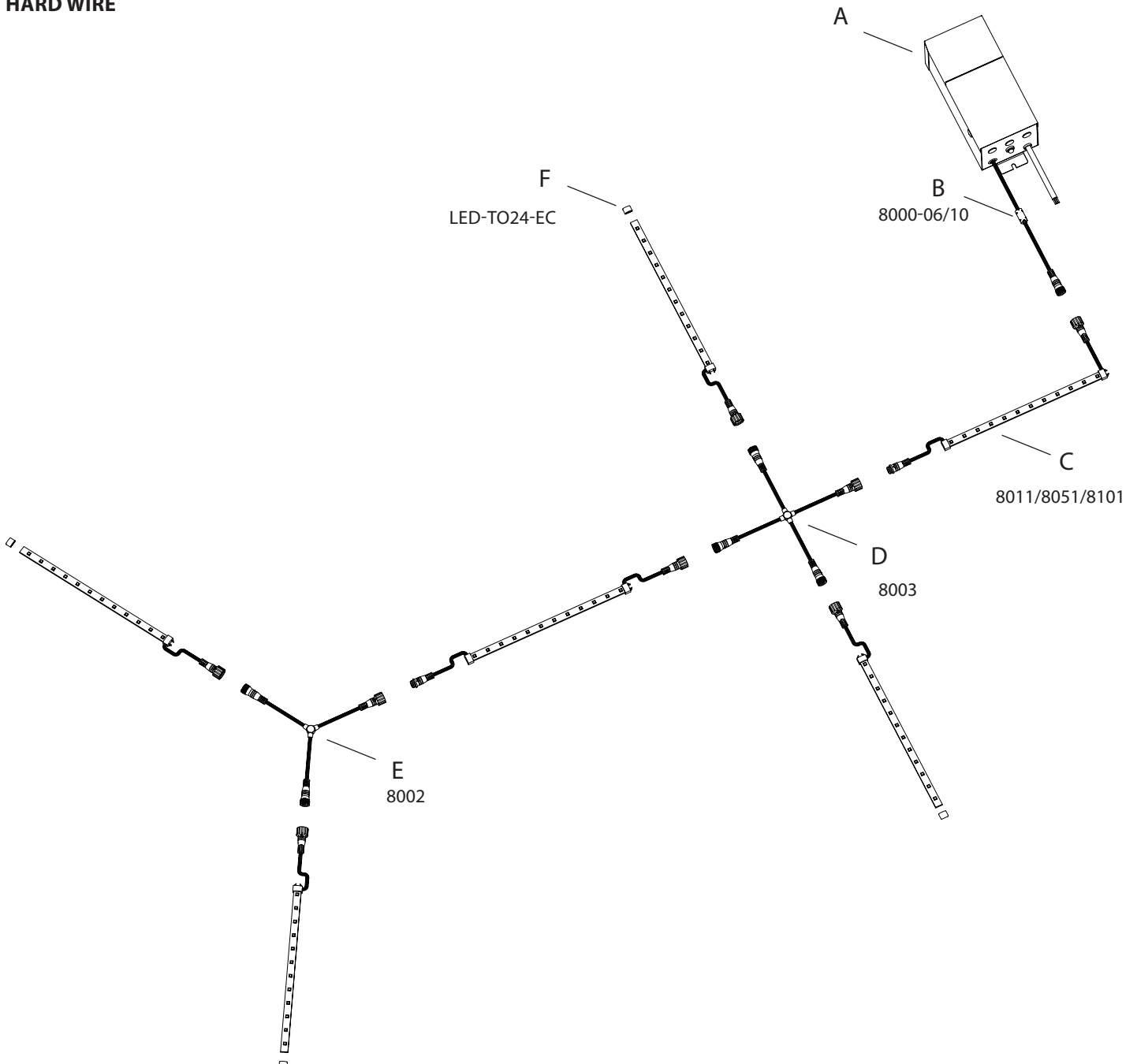

waclighting.com  
 Phone (800) 526.2588  
 Fax (800) 526.2585

**Headquarters/Eastern Distribution Center**  
 44 Harbor Park Drive  
 Port Washington, NY 11050

**Central Distribution Center**  
 1600 Distribution Ct  
 Lithia Springs, GA 30122

**Western Distribution Center**  
 1750 Archibald Avenue  
 Ontario, CA 91760

# INSTALLATION INSTRUCTION

## Landscape 12V Outdoor Tape

8011/8051/8101

# WAC LIGHTING

Responsible Lighting®

### ACCESSORIES

#### 1. INSTALLATION CHANNEL (LED-TO24-CH1/5)

flat surface, exaple: wood

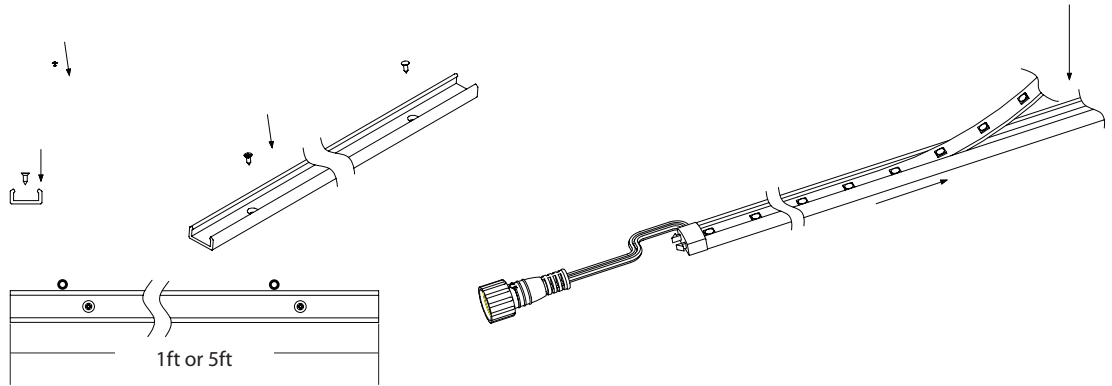

#### 2. CLIP 1 (LED-TO24-C1)

- Suitable for non-flat installation surface, wood or concrete.
- Installation surface have space for the two mounting screw holes.
- No edge contact installation requirement.

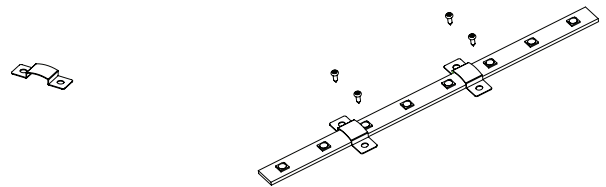

#### 3. CLIP 2 (LED-TO24-C2)

- Suitable for non-flat installation surface, wood or concrete material applicable
- Suitable for single tape edge contact installation

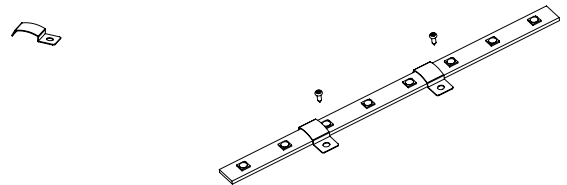

#### 4. CLIP 3 (LED-TO24-C3)

- Suitable for non-flat installation surface, wood or concrete material applicable
- Suitable for double tape edge contact installation.

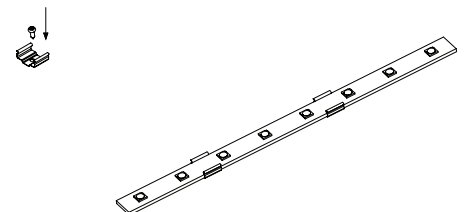

waclighting.com

Phone (800) 526.2588

Fax (800) 526.2585

Headquarters/Eastern Distribution Center

44 Harbor Park Drive

Port Washington, NY 11050

Central Distribution Center

1600 Distribution Ct

Lithia Springs, GA 30122

Western Distribution Center

1750 Archibald Avenue

Ontario, CA 91760