

INSTALLATION INSTRUCTION

Flood - Color Changing

5021-CCBBR

WAC LIGHTING

Responsible Lighting®

WARNING

IMPORTANT: NEVER attempt to do any work without shutting off the electricity.

1. Read all instructions before installing.
2. System is intended for installation by a qualified electrician in accordance with the National Electrical Code and local regulations.
3. Place the wall switch in the "OFF" position.
4. Go to the main fuse box, or circuit breaker. Unscrew the fuse(s) or switch "OFF" the circuit breaker switch(es) that control the power to the space that you are working on.

CAUTION

- All parts must be used as indicated in these instructions. Do not substitute any parts, leave parts out, or use any parts that are worn out or broken. Failure to follow this instruction may invalidate the UL listing of this fixture.

AVERTISSEMENT

IMPORTANT : Coupez l'électricité avant TOUTE manipulation.

- Lisez toutes les instructions avant d'installer.
- Système est destiné à être installé par un électricien qualifié en conformité avec le code national de l'électricité et les règlements locaux.
- Placez l'interrupteur mural en position d'arrêt (« OFF »).
- Toujours mettre le fusible ou le disjoncteur en position arrêt dans la pièce ou des travaux électriques sont prévus

MISE EN GARDE

- Toutes les pièces doivent être utilisées tel qu'il est indiqué dans ces instructions. Ne remplacez pas les pièces, n'en laissez pas de côté et ne les utilisez pas si elles sont usées ou brisées. Le non-respect de ces instructions peut annuler l'homologation UL du luminaire.

ADVERTENCIA

IMPORTANTE: NUNCA intente hacer trabajos sin desconectar el suministro eléctrico.

- Lea y comprenda todas las instrucciones e ilustraciones por completo antes de proceder con el ensamblaje e instalación de esta lámpara.
- Sistema está diseñado para ser instalado por un electricista calificado, de acuerdo con el código eléctrico nacional y las normas locales.
- Coloque el interruptor de la pared en la posición "OFF" (APAGADO).
- Diríjase a la caja de fusibles o a la caja del interruptor de circuito principal en su hogar. Coloque el interruptor de alimentación principal en la posición "OFF" (APAGADO).

PRECAUCIÓN

- Todas las piezas deben usarse como lo indican estas instrucciones. No reemplace las piezas, no omita piezas durante la instalación ni utilice piezas gastadas o rotas. El incumplimiento de esta indicación podría invalidar la calificación UL esta lámpara.

This instruction apply to the model(s) below:

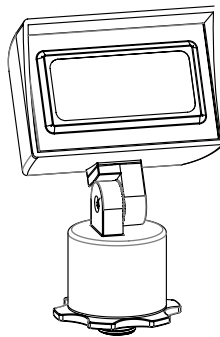

5021-CCBBR

waclighting.com

Phone (800) 526.2588

Fax (800) 526.2585

Headquarters/Eastern Distribution Center

44 Harbor Park Drive

Port Washington, NY 11050

Central Distribution Center

1600 Distribution Ct

Lithia Springs, GA 30122

Western Distribution Center

1750 Archibald Avenue

Ontario, CA 91760



INSTALLATION INSTRUCTION

Flood - Color Changing

5021-CCBBR

WAC LIGHTING

Responsible Lighting®

MOUNTING ACCESSORIES



Mounting Stake
Qty: 1 pcs



Outdoor Rated Wire Nut
(Not included in 5022 model)
Qty: 2 pcs

Step 1: Determining the location

1. Make sure your main power is off.
2. At the point of installation, mount the stake by placing a piece of wood on the stake and hammering the wood. Hammer till the bottom of the ring is flush with the ground.
3. In the case of hard soil, dig a hole and place the stake in so that the bottom of the ring is flush with the ground. Fill the rest of the hole with the removed soil and pack it tight to secure the stake.
4. Screw the fixture onto the stake provided, leading the wire from the fixture through the wire slot in the stake.

Step 2: Wiring the Fixture

5. Cut the power supply wire from the transformer at the location of the fixture.
6. Separate the power supply wire into two individual wires by lightly pulling on each side so that a couple inches is separated.
7. Strip off ½ inch of the insulating material from each wire and connect one to each of the wires from the fixture using the outdoor rated direct burial wire nuts provided.

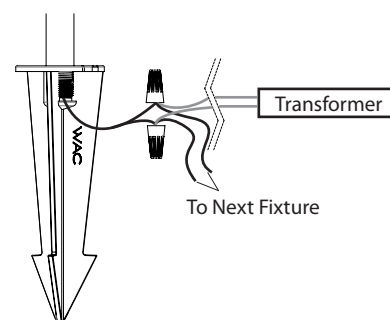
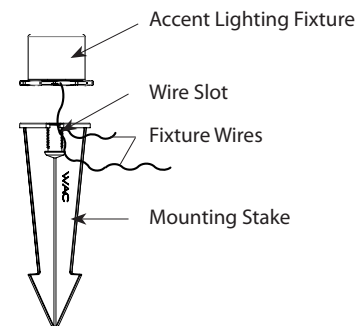
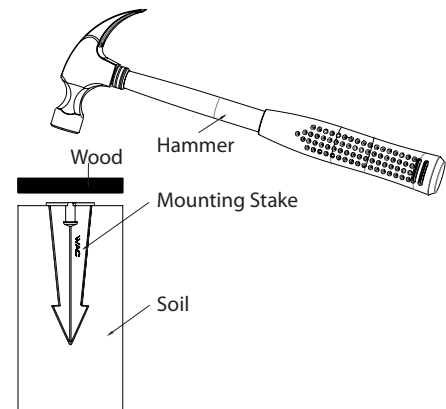

Note: To install multiple fixtures, also connect the power supply wire of each additional fixture to the connection described in 7 of the previous fixture.

waclighting.com
Phone (800) 526.2588
Fax (800) 526.2585

Headquarters/Eastern Distribution Center
44 Harbor Park Drive
Port Washington, NY 11050

Central Distribution Center
1600 Distribution Ct
Lithia Springs, GA 30122

Western Distribution Center
1750 Archibald Avenue
Ontario, CA 91760



INSTALLATION INSTRUCTION

Flood - Color Changing

5021-CCBBR

WAC LIGHTING

Responsible Lighting®

Step 3: Installing the Fixture

8. Screw the fixture onto the stake provided, leading the wire from the fixture through the wire slot in the stake.
9. If desired, bury your wire by digging a small trench. Close the trench by applying an inward force to both sides of the trench.
10. Repeat steps for other fixtures in the same electrical circuit.
11. Turn the main power supply back on and make sure the fixtures light up.

Step 4: Aiming the Fixture

12. Tilting: Loosen the joint screw and adjust the head of the fixture to the desired direction before retightening the screw.
13. Rotating: Loosen the mounting knob and rotate the fixture to the desired position before retightening the knob.

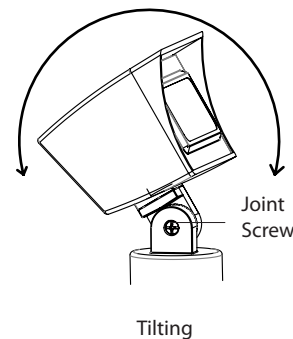
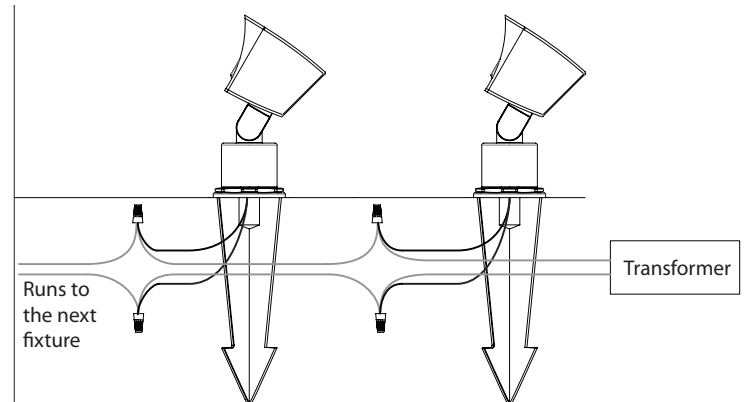

Tilting

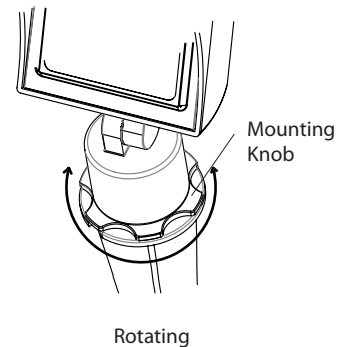

Rotating

waclighting.com
Phone (800) 526.2588
Fax (800) 526.2585

Headquarters/Eastern Distribution Center
44 Harbor Park Drive
Port Washington, NY 11050

Central Distribution Center
1600 Distribution Ct
Lithia Springs, GA 30122

Western Distribution Center
1750 Archibald Avenue
Ontario, CA 91760



INSTALLATION INSTRUCTION

Flood - Color Changing

5021-CCBRR

WAC LIGHTING

Responsible Lighting®

ACCESSORIES

I. Lens Accessory:

Frosted, red, blue, green and amber lens accessories are used to alter the spectrum and distribution of the light coming out of the fixture.

Installation: Place the lens to the cover clip and clip into the fixture.

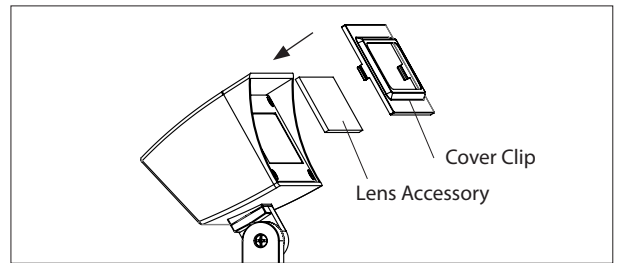

II. Surface Mount Accessory

The surface mount accessory is used to mount the fixture to a hard surface like wood or cement or as alternative to the mounting stake.

Installation: Mount the accessory to a hard surface using No. 10 Philips head screws that are at least half an inch long. If mounting on concrete or something similar, first use a plastic anchor sized for No. 10 screws. If mounting on a soft surface first attach the included spikes.

Create a route underneath the accessory for your wire to travel through. Lead your wire through the created route and screw your fixture onto the surface mount accessory.

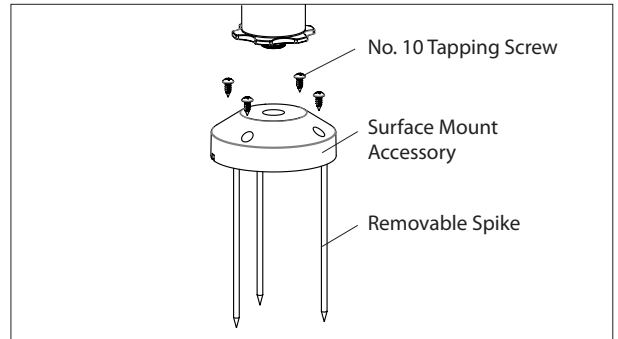

III. Tree Mount Accessory:

The tree mount accessory is a way for fixtures to be mounted on the trunk or a branch of a tree while minimizing damage to the tree.

Installation: Mark the screw hole locations at the point of installation. Thread one hex nut onto the screw until it is stopped by the wood screw portion. Use a wrench to screw the bolt into the tree until the unthreaded portion of the bolt meets the surface of the tree. (Do this for all three bolts.) Place the tree mount bracket onto the bolts and secure it using additional hex nuts. Attach light fixture and lead wire through the bracket. Place all wire nuts into the tree mount bracket.

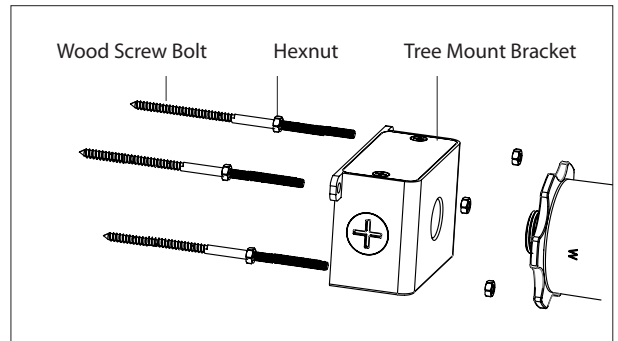

IV. Extension Accessory

Using extension rods and rod joiners, fixtures can be mounted away from a surface in any desired direction.

Rods come in 5 sizes: 4 inches, 8 inches, 12 inches, 18 inches, and 24 inches. These rods can be connected via either straight or 90 degree rod joiners.

Installation: Screw in a rod joiner into your mounting accessory. Screw an extension rod to the other side of the rod joiner. Continue to use rod joiners and extension rods until the fixture is in the desired position.

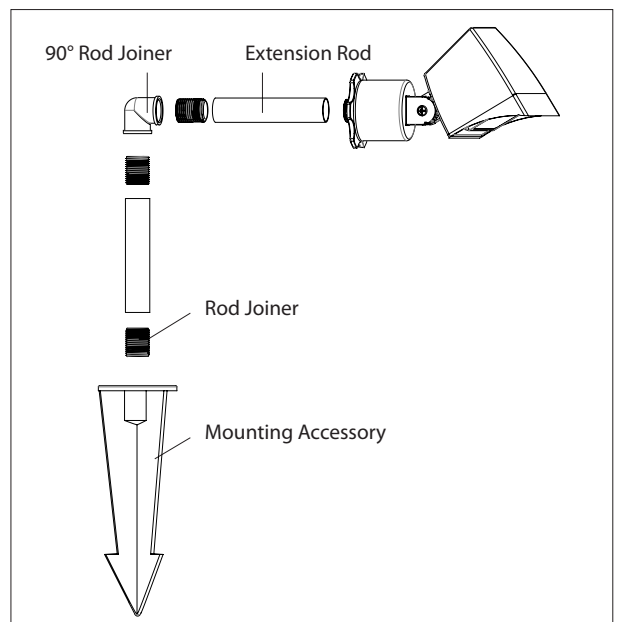

wacighting.com

Phone (800) 526.2588

Fax (800) 526.2585

Headquarters/Eastern Distribution Center

44 Harbor Park Drive

Port Washington, NY 11050

Central Distribution Center

1600 Distribution Ct

Lithia Springs, GA 30122

Western Distribution Center

1750 Archibald Avenue

Ontario, CA 91760



SETUP INSTRUCTION

ilumenight Color Changing Instruction Manual v. 1.0

Written with Tunable Color v. 4.1.3

System Requirements: iOS 8.4+

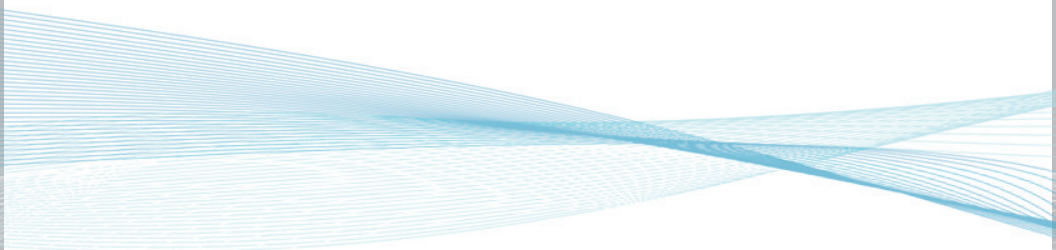

WAC

LANDSCAPE LIGHTING

WAC LIGHTING

Responsible Lighting®

Accent 12V Color Changing

Color and brightness controlled with
Ilumenight™ mobile app



Input	9-15VAC
Power	0.5W to 14.5W / 1VA to 17VA
Brightness	Up to 355 lm
Beam Angle	15° to 60°
CRI	95+
Rated Life	45,000 hours

Adjustable beam angle

5011-CCBBR | Bronze on Brass
5011-CCBZ | Bronze on Aluminum

Wall Wash 12V Color Changing

Color and brightness controlled with
Ilumenight™ mobile app



Input	9-15VAC
Power	0.5W to 14.5W / 1VA to 17VA
Brightness	Up to 430 lm
Beam Angle	15° upward (50° by 80°)
CRI	95+
Rated Life	45,000 hours

5021-CCBBR | Bronze on Brass

3" Inground 12V Color Changing

Color and brightness controlled with
Ilumenight™ mobile app

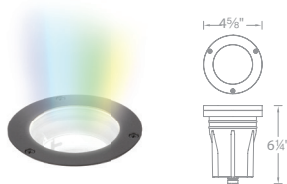

Input	9-15VAC
Power	0.5W to 14.5W / 1VA to 17VA
Brightness	Up to 250 lm
Beam Angle	15° to 60°
CRI	95+
Rated Life	45,000 hours

Adjustable beam angle

5031-CCBBR | Bronze on Brass

WAC LIGHTING

Responsible Lighting®

TABLE OF CONTENTS

1. Overview	2
2. Getting Started	3
2.1 Create Account	
2.2 Login with an Account	
2.3 'Do This Later' (Login without an Account)	
3. Main Screen	5
4. Commissioning Screen	6
4.1 Commissioning Controls	
4.2 SceneSet®	
5. Options Menu	9
5.1 Add New Group	
5.2 Discovery Distance	
5.3 Logout	
5.4 Change Password	
5.5 Reset Lights Password	
5.6 Reset Application	
5.7 About This App	
5.8 Support	
5.9 Legal	
5.10 Console	

1. OVERVIEW

The WAC ilumenight Color changing iOS app enables control of Bluetooth-equipped araya modules incorporated into a lighting fixture. The app is designed for use by professional lighting specifiers and designers.

System Requirements: iOS 8.4+

Type “ilumenight” in the Search window in the App Store screen to view and download the app on your iOS device.



After downloading and launching, the user can create an account that enables the lamps to be secured such that others cannot control them unless they use the same password. Upon discovery, the lamps and modules (including the Digital Control Adapter) can be named, and if desired, assigned to a group.

The app enables the user to set the Correlated Color Temperature (CCT), Dimming, Saturation and Hue for each lamp/group. SceneSet® enables up to five scenes — a scene is any combination of CCT, Dimming, Saturation and Hue — to be programmed into the lamp for recall by the app or a 0-10V connection.

For lamps connected to a 0-10V line, SceneSet® Mode can also be specified in the app

2. GETTING STARTED

Make sure that the lighting fixture is turned on.

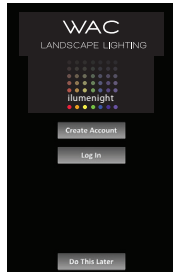

Download the latest version of the WAC ilumenight color changing app from the App Store and launch the app (version 4.1.3 as of this writing).

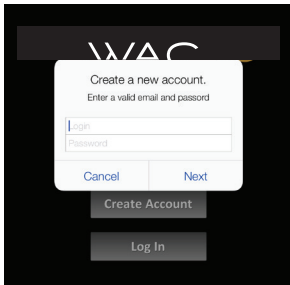

Create a new account name and password to secure and control any Bluetooth-equipped unlocked lamps that are “discovered” by the app with a green  icon.

Lamps with a magenta  icon cannot be controlled (see Main Screen section for further details).

- Enter a desired user name (email address) and password. Click on the “Next” button.

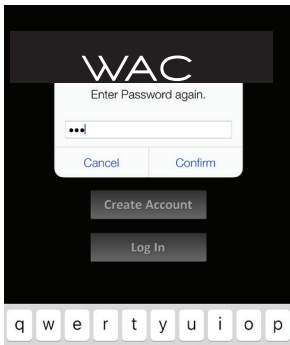

- Confirm your password by entering it again. Click on the ‘Confirm’ button.

NOTE: The password you create will be assigned to any unlocked lamps and automatically lock them.

2. GETTING STARTED

Make sure that the lighting fixture is turned on.

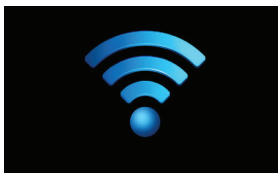
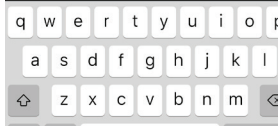
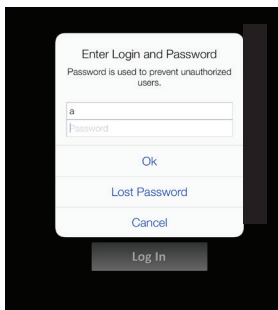



2.2 Login with an Account

If you have already created an account, you can log in by entering your email address and your password and then pressing “OK”. When you log in with your password, you will be able to control any lamps that you have previously secured with this password, as well as control any unlocked lamps (with a green  icon).

Lamps with a magenta  icon indicate that the same user name was used earlier to secure these lamps, but the password was different. You will not be able to control these lamps since they were previously locked using a different password (see Main Screen section for further details).

NOTE: The password you use for logging in will be assigned to any unlocked lamps and automatically lock them.

2.3 ‘Do This Later’ (Login without an Account)

Using this option, you will bypass the Create Account and Log In steps. It allows you to access unlocked lamps (with a green  icon) as well as discover — but NOT control — the values of locked lamps (with a red  icon).

NOTE: When you log in without an account, you cannot lock the lamps to prevent access by others, and some buttons on the Options menu are not available (“grayed out”) to prevent unauthorized use.



After completing one of these three startup options, the app scans the network to discover lamps.

3. MAIN SCREEN

The main screen lists all discovered lamps and shows a default group name (see Commissioning Screen section on how to rename the lamp and/or group).

In the main screen, the lamps can be turned on and off by tapping the on/off icon on the left of the slider. The lamps can also be dimmed by moving the slider right or left, or by tapping to the right or left of the slider. The dimming level as a percentage of light output is shown to the right of the slider. The signal strength of the Bluetooth connection is shown below the slider. On lamps that support power consumption, the consumed wattage is also shown below the slider.

To the right of the slider, there is one of three icons: green, red, or magenta.

- If  is green, the lamp is unlocked and can be commissioned.
- If  is red, you are not logged in (“Do This Later” option), the lamp is locked (secured by someone else), and it cannot be controlled.
- If  is magenta, the lamp is assigned to the user name, but under a different password. This lamp cannot be controlled unless the password that was previously used to secure the lamp is entered.

An arrow to the left of the on/off icon indicates whether a lamp is assigned to a group

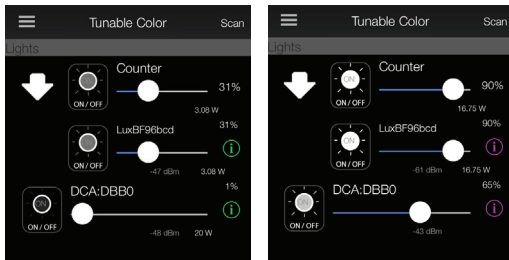

By default, the arrow points downward, and the sliders for lamp(s) that belong to that group will be displayed to allow for individual control of each lamp (if  is green).

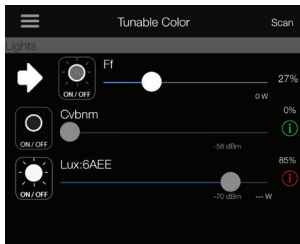

Clicking on the arrow will change its orientation to the right, and will hide the list of lamps belonging to that group.

NOTE: Any changes made to the group dimming slider or the on/off button will apply to all of the lamps in that group.

To commission the lamp, tap on the green  to launch the Commissioning Screen.

4. COMMISSIONING SCREEN

4.1 Commissioning Controls

The lamp can be commissioned by dragging the sliders left or right, tapping on either side of the slider circle to move at preset values, or pressing and holding along the slider for one second to bring up a numerical keypad for direct entry of the value. When using the direct entry option, you can also use the two arrows located on the top left of the numerical keypad; tap on either arrow to automatically increase or decrease the value.

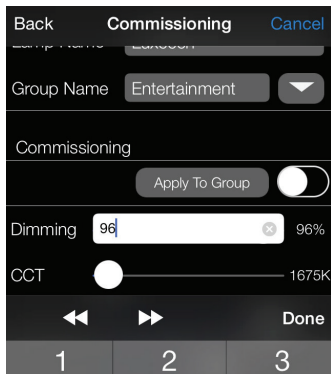

4.1.1 Dimming

The lamp (or the group) can be dimmed from 100–1%, in increments of 1%. The dimming value is shown at the far left.

Tapping on either side of the slider moves the lamp in 10% increments.

Pressing and holding along the slider will bring up a keypad for direct entry of the dimming percentage. Enter the percentage and then touch "Done".

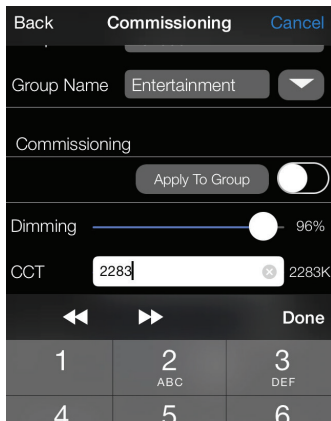

4.1.2 CCT

The CCT can be changed in increments of 25K.

The CCT range of the lamp (1650 – 4000K or 2700 – 6000K) is detected automatically.

Tapping on either side of the slider moves the lamp in 25K increments.

Pressing and holding along the slider will bring up a keypad for direct entry of the CCT. Enter the CCT and then touch "Done".

NOTE: Only lamps of the same CCT range can be grouped together.

4. COMMISSIONING SCREEN

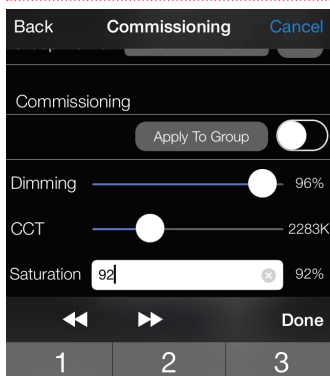

4.1.3 Saturation

Saturation adds gradients of color to a white point. Saturation can be added in increments of 1%, from 0 - 100% (fully saturated).

Tapping on either side of the slider moves the lamp in 10% increments.

Pressing and holding along the slider will bring up a keypad for direct entry of the saturation percentage. Enter the percentage and then touch "Done".

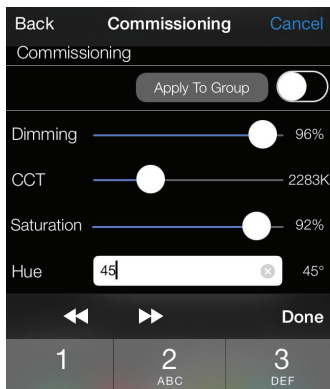

4.1.4 Hue

Hue enables different colors to be added to the light in values from 1 to 60.

Tapping on either side of the slider moves the lamp in 6° increments.

Pressing and holding along the slider will bring up a keypad for direct entry of the hue value. Enter the value and then touch "Done".

4.1.5 'Apply to Group' Button

If more than one lamp is assigned to a group, the Apply to Group button is displayed. Tapping on this button will apply the current commissioning choices (made to a single lamp) to all of the lamps in the same group.

If this switch is toggled to the "on" position, any changes made to the lamp will always be applied to the entire group in real time.

4. COMMISSIONING SCREEN

4.2 SceneSet®

Allows up to five scenes to be programmed into the lamp and recalled by simply tapping one of the five SceneSet buttons.

To activate SceneSet, tap on any one of the SceneSet rectangles (labeled “1”, “2”, “3”, “4” or “5”). Commission the lamp as previously described. To save scenes, press and hold one of the SceneSet buttons until either a beep is heard (iPod and iPad) or the device vibrates. The SceneSet button will then display the dominant color of the scene as a visual cue.

TIP: If the device does not vibrate or make a sound, check to ensure that sounds and vibration are enabled.

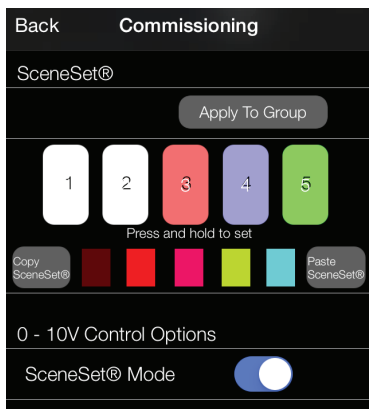

NOTE: This program allows up to 8 fixtures to be connected as a group.

4.2.1 'Apply to Group' Button

If more than one lamp is assigned to a group, the Apply to Group button is displayed. Tapping on this button will apply the current SceneSet color (saved to a single lamp) to all of the lamps in the same group.

4.2.2 'Copy/Paste Scenaset' Buttons

The “Copy SceneSet” button will copy all of the 5 current SceneSet color scenes, and display them in the smaller rectangles shown. You can then paste these 5 scenes to the SceneSet settings of another lamp (either in the same group or in another group) by choosing that lamp from the Main Screen and clicking on the “Paste SceneSet” button.

4.2.3 0 - 10V Control Option

When the lamp is connected to a 0-10V line, the default is control of Correlated Color Temperature (CCT). If desired, the 0-10V line can be set to control SceneSet by sliding the SceneSet Mode button to the “on” position. In this mode, the 0-10V control will toggle the light between up to 5 preset scenes.

5. OPTIONS MENU (UPPER RIGHT OF COMMISSIONING SCREEN)

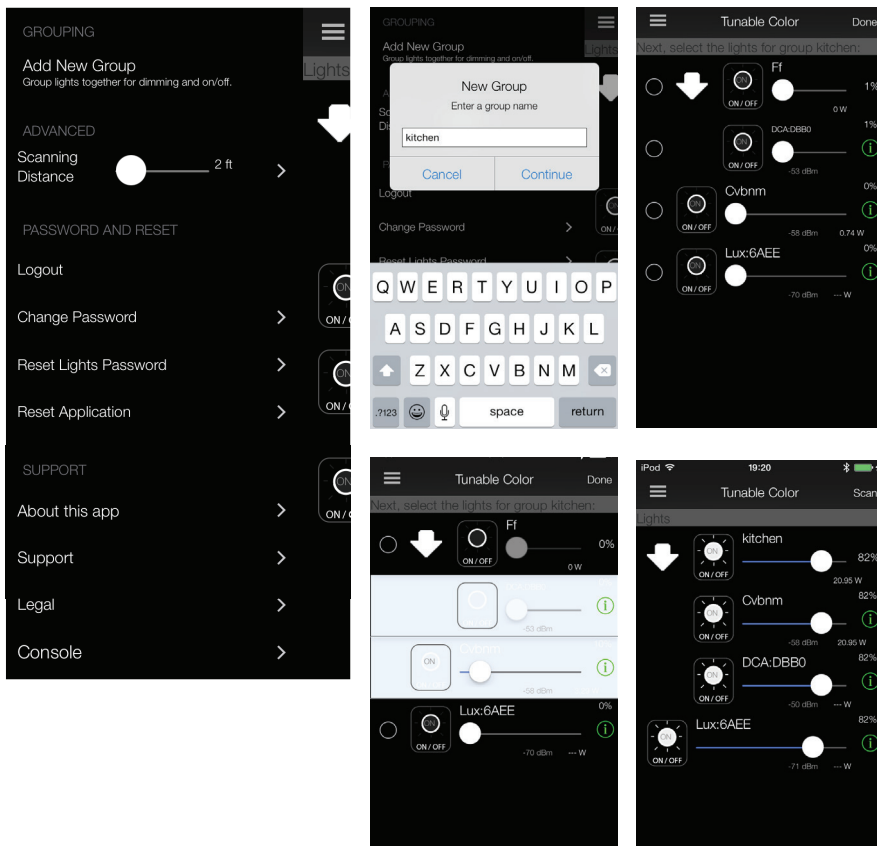

5.1 Add New Group (only active when logged in)

New groups can be created and named here first, and then the lamp(s) belonging to each new group can be chosen directly on the Main Screen.

This process makes it easier to group many lamps at a time.

5. OPTIONS MENU (UPPER RIGHT OF COMMISSIONING SCREEN)

5.2 Discovery Distance

This changes the discovery distance. When commissioning multiple lamps, reducing the discovery distance enables connection to the closest lamp.

5.3 Logout

Logs out of the current account.

5.4 Change Password (only active when logged in)

Changing the password will change the current account password. This will secure the lamps that have been commissioned using the original password, and the ⓘ icon for those lamps on the Main Screen will turn magenta.

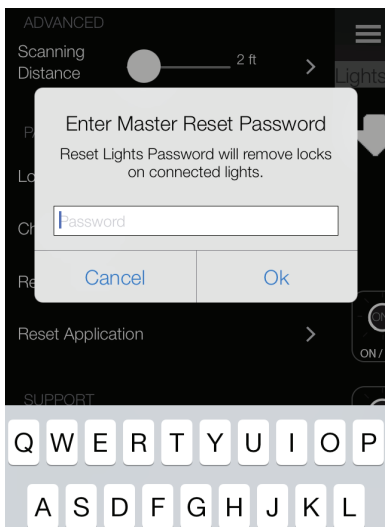

5.5 Reset Lights Password (only active when logged in)

This command will clear the password that was set for each lamp currently displaying in the app. It will ask the user for a Master Password (different from the login password) to perform this operation. This Master Password can be obtained by contacting your WAC LIGHTING sales representative.

NOTE: Internet access is required to perform this action.

5.6 Reset Application

Used mainly for debugging purposes, this operation will delete the account and password, remove the control on the lamps and perform a refresh.

NOTE: Internet access is required to perform this action.

5. OPTIONS MENU (UPPER RIGHT OF COMMISSIONING SCREEN)



5.7 About This App

Provides information about the release and build number of the app. If you tap on the website link provided, the app will exit and take you to a web browser pointing to the WAC LIGHTING website.

5.8 Support

Please call our technical support team at 800.526.2588

5.9 Legal

Provides necessary and important legal information about the nature and use of the app.

For PDF version of this instruction manual, please visit waandscapelighting.com

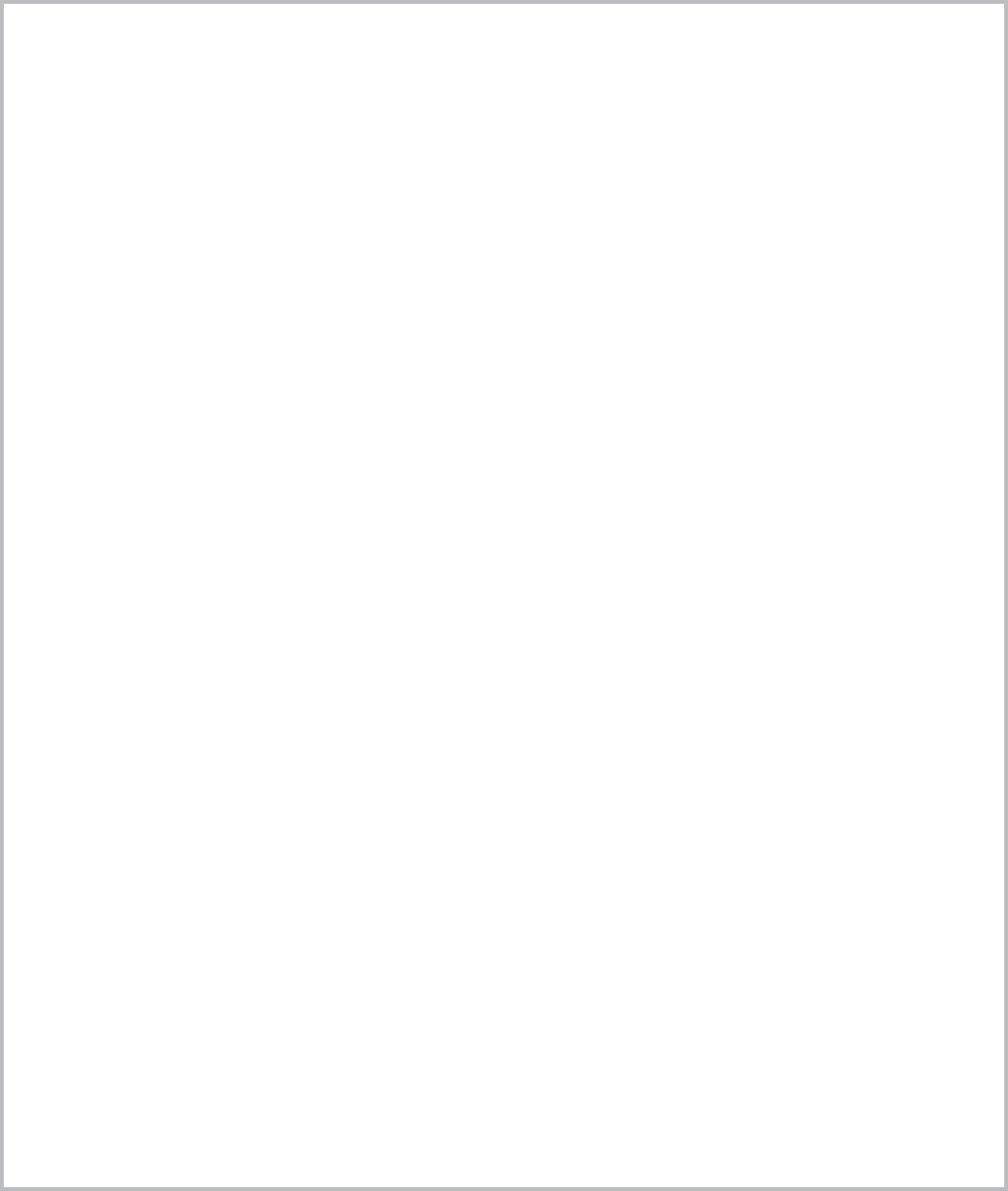

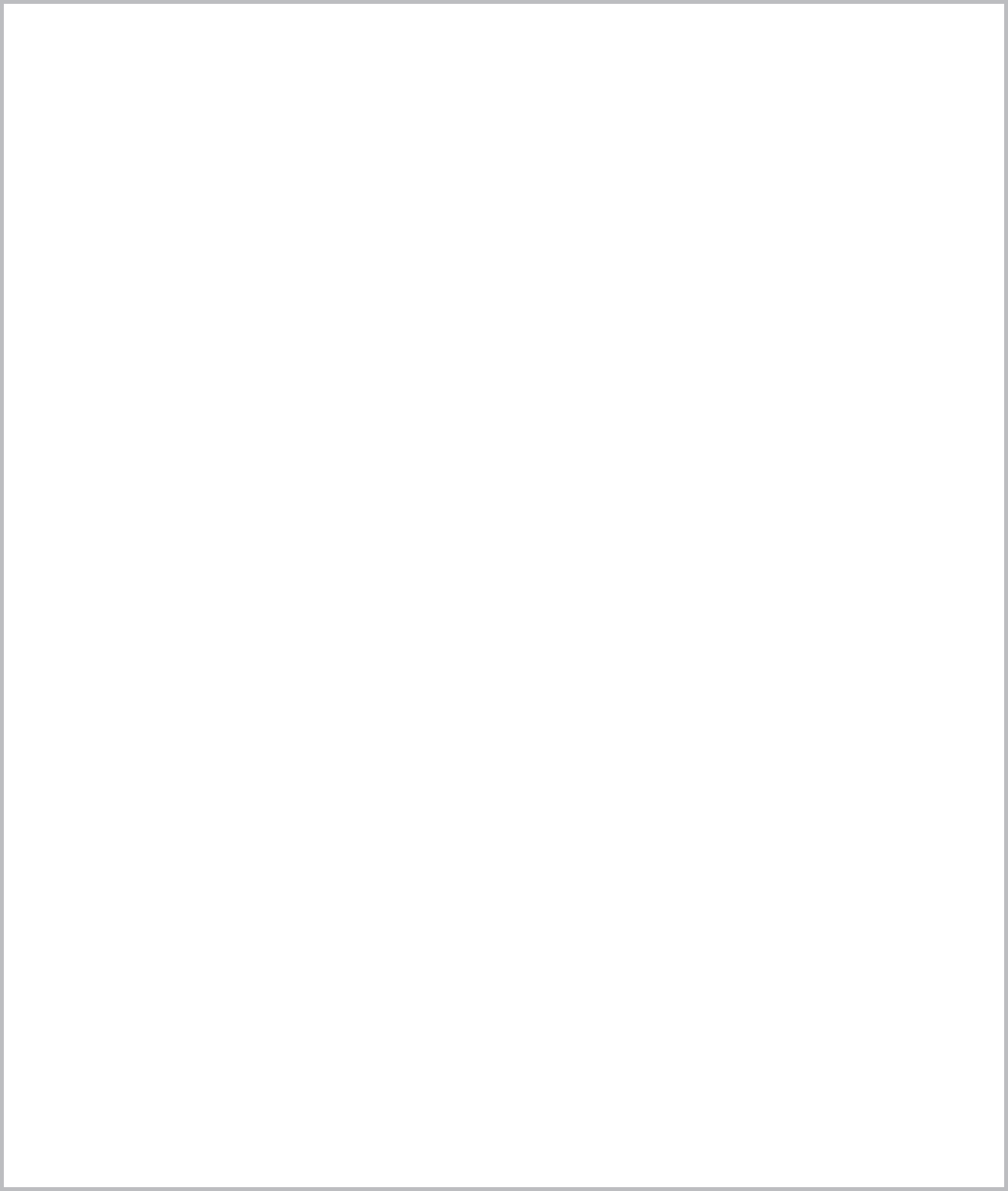



WAC
LANDSCAPE LIGHTING

www.waclandscapelighting.com

Specifications subject to change without notice