

VON DUPRIN®

98/99™ Series
Exit Devices



IR Ingersoll Rand
Security Technologies

Introduction

Exit devices are a critical part of the Fire and Life Safety egress system and will provide safe and reliable service when properly applied and maintained. Von Duprin designs and manufactures exit devices in accordance to ISO 9001 Quality Management System and meets or exceeds accepted U.S. domestic and International standards. All 98 and 99 Series exit devices are UL listed for Panic Hardware or Fire Hardware, and are certified to ANSI A156.3, 2001, Grade 1. Many models are also certified for Hurricane Resistant Applications. Consult your local Security & Safety consultant (SSC) or the Von Duprin factory for current listings.

It is intended that the information included in this publication, when properly used, will provide clear and reliable guidelines to the proper general selection and application. However, the scope of the information is necessarily limited.

VON DUPRIN

Administrative Offices
2720 Tobey Dr.
Indianapolis, IN 46219

Customer Service

877-671-7011
800-999-0328 - Fax

Technical Support

877-671-7011

Von Duprin exit devices are available in two external surface styles, designated 98 and 99 Series.

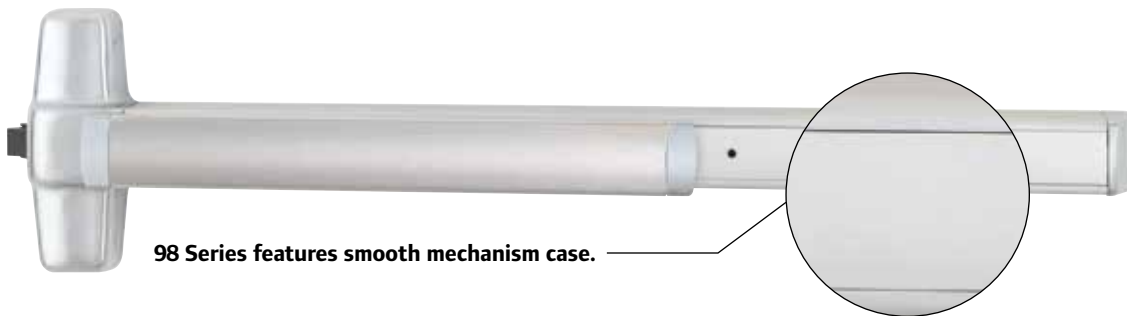

98 Series features smooth mechanism case.

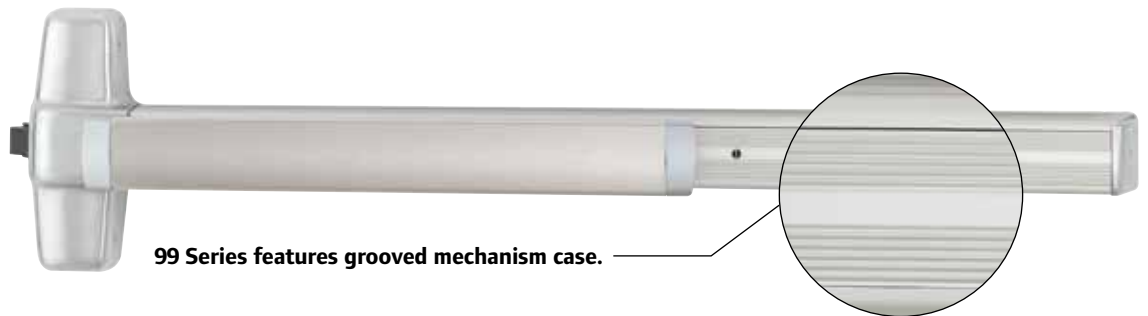

99 Series features grooved mechanism case.



Latch Bolt
Deadlocking latchbolt provides security and improved performance at standard device cost.

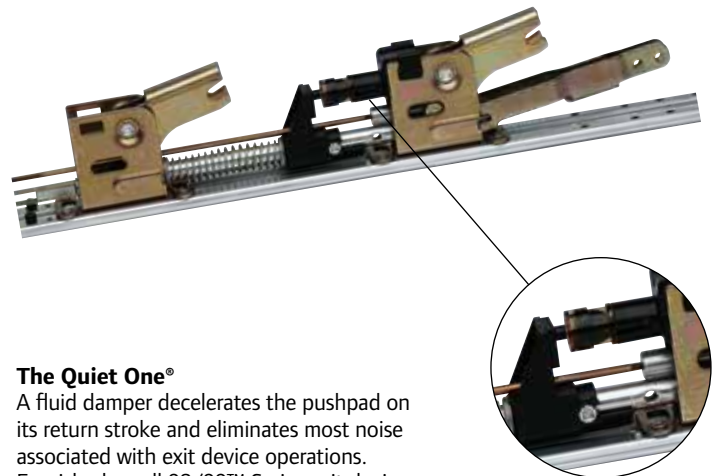

The Quiet One®
A fluid damper decelerates the pushpad on its return stroke and eliminates most noise associated with exit device operations. Furnished on all 98/99™ Series exit devices.

Be sure to ask your SSC representative to tell you about **Custom Solutions** by Ingersoll Rand Security Technologies. To learn more visit securitytechnologies.ingersollrand.com.



QuietSolutions



CustomDécor



HighSecurity and Safety



EnvironmentalSolutions



FlexibleConfigurations

Table of Contents

	Exit Hardware	Fire Exit Hardware
Rim Devices	98/99™ 8	98-F/99-F™ 10
	Trim..... 9	Trim..... 11
Mortise Lock Devices	9875/9975 12	9875-F/9975-F 14
	Trim..... 13	Trim..... 15
Surface Mounted Vertical Rod Devices	9827/9927 16	9827-F/9927-F 18
	Trim..... 17	Trim..... 19
Three-Point Latching Devices	9857/9957 20	9857-F/9957-F 22
	Trim..... 21	Trim..... 23
Concealed Vertical Rod Devices	9847/9947 24	9847-F/9947-F 26
	Trim..... 25	Trim..... 27
	9848/9948 28	9848-F/9948-F 30
	Trim..... 29	Trim..... 31
Concealed Vertical Cable Devices	9849/9949 32	9849-F/9949-F 34
	Trim..... 33	Trim..... 35
Wood Door Concealed Vertical Rod Devices	9847WDC/9947WDC 36	9847WDC-F/9947WDC-F 38
	Trim..... 37	Trim..... 39
Wood Door Concealed Vertical Cable Devices	9849WDC/9949WDC 40	9849WDC-F/9949WDC-F 42
	Trim..... 41	Trim..... 43

Options & Accessories

Applications & Trim Operation	Single & Double Door Applications Door Handing Outside Trim Operation Lever Styles	Electrical Options	Request to Exit Latchbolt Monitoring Signal Switch Chexit® Alarm Kit Electric Mortise Lock Device Electric Latch Retraction Quiet Electric Latch Retraction
Trim Options	Knob Thumbpiece Lever Electrified Outside Lever Trim (E996L) Breakaway Lever Thumbturn Control Hospital Pull Offset Pull Vandal Resistant Pull AD-Series Adaptable Electronic Trim	Electrical Accessories	Power Supplies Electric Power Transfer
Strike Options	Strike/Stile Information Strikes	Mechanical Options	XP98/99 Rim Exit Device WS Surface Vertical Rod Exit Device Less Bottom Rod Pullman Latch Dummy Push Pad Braille, Embossed, Knurled and Safety Glow (Luminescent) Touchpads
Dogging Options	Cylinder Dogging Hex Key Dogging Less Dogging Dogging Keys Special Center Case Dogging Double Cylinder	Pneumatic Options	Pneumatic Controlled Exit Devices Pneumatic Power Transfer
		Device Accessories	Glass Bead Kit Vertical Rod and Latch Guard Cover Plate Kits Cylinders Mullions Sex Bolts
		Additional Information	ANSI Function, Grade & Type UL Fire Labeling and Opening Size
		Finishes	Standard & Special Finishes

How to Order

VON DUPRIN®

		EL	99	27	-L	-16	-F	LBR	3'	US3	RHR
None	Standard										
SD	Special Dogging R/VR - Panic Only										
CD	Cylinder Dogging - Panic Only										
CX	Chexit										
E	Electric Locking Mortise/Lever										
QEL	Quiet Electric Latch Retraction										
EL	Electric Latch Retraction										
LX	Latch Bolt Monitoring										
RX	Request to Exit										
RX2	Double Request to Exit										
SS	Signal Switch										
PL	Pullman Latch										
PN	Pneumatic Latch Retraction										
WS	Surface Vertical Rod Exit Device										
XP	Heavy Protection - Rim										
98	Series 98-smooth										
99	Series 99-grooved										
None	Rim Device										
27	Surface Mounted Vertical Rod Device										
47	Concealed Vertical Rod Device										
47WDC	Concealed Vertical Rod Wood Door Device										
48	Concealed Vertical Rod Device										
49	Concealed Vertical Cable Device										
49WDC	Concealed Vertical Cable Wood Door Device										
57	Three-Point Latch Device										
75	Mortise Lock Device										
XX	AD Trim (to come from client)										
DT	Dummy Trim										
EO	Exit Only										
HL	Hospital Pull Trim										
K	Knob										
K-BE	Knob - Blank Escutcheon										
K-DT	Knob, Rigid - Dummy Trim										
K-NL	Knob, Rigid - Night Latch										
L	Lever (Classroom)										
L-BE	Lever - Blank Escutcheon										
L-DT	Lever, Rigid - Dummy Trim										
L-NL	Lever, Rigid - Night Latch										
NL	Night Latch										
NL-OP	Night Latch Cylinder Assembly, Optional Pull										
TL	Turn Lever										
TL-BE	Turn Lever - Blank Escutcheon										
TP	Thumbpiece										
TP-BE	Thumbpiece - Blank Escutcheon										
XX	Lever Style 06 standard Optional 01, 02, 03, 05, 07, 12 (Handed), 16 (Omega), 17, 18, Accent, Asti, Merano, St. Annes										
F	Fire Exit Device										
-2	Double Cylinder (Rim & Mortise Only)										
LBR	Less Bottom Rod										
LBL	Less Bottom Latch										
SG	Safety Glow (Luminescent) Touchpad										
ALK	Alarm Kit										
ALK-AR1	Auto-Reset 1½ minute Alarm Kit										
ALK-AR3	Auto-Reset 3 minute Alarm Kit										
ALK-AR6	Auto-Reset 4½ minute Alarm Kit										
2'	2' Device (2' Door Size) 27, 47 or 49 only										
3'	3' Device (2' 4" - 3' Door Size)										
4'	4' Device (2' 10" - 4' Door Size)										
Finishes	US3, US4, US10, US26, US26D, US28, 313, 315 US32D - 98 ONLY -AM Antimicrobial (available US26D and US32D)										
-LHR	Left Hand Reverse										
-RHR	Right Hand Reverse										

Popular Applications & Handing

Single Door Applications

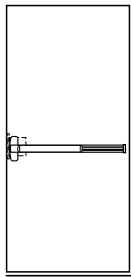

Single mortise lock device

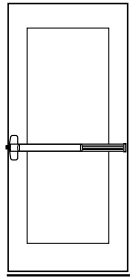

Single rim device

Double Door Applications

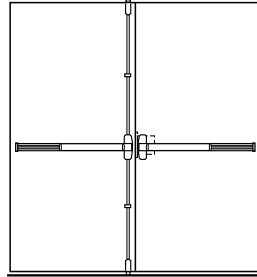

Mortise lock and surface mounted or concealed vertical cable/rod device combination—same direction

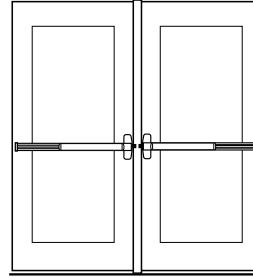

Two rim devices with mullion—same direction

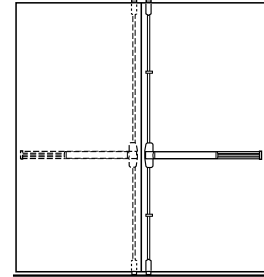

Two vertical rods—double egress

Door Handing

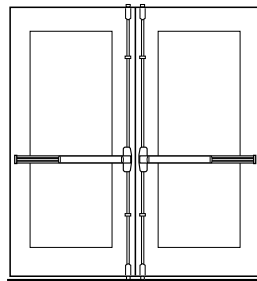
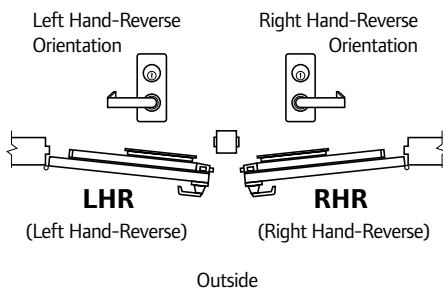

Two surface mounted vertical rod devices—same direction (do not use with overlapping astragal)

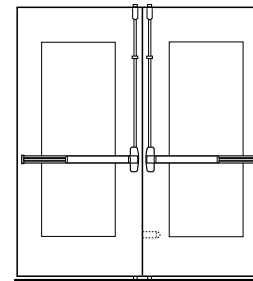

Two Fire Exit Hardware vertical cables/rods with auxiliary fire latch-LBR option

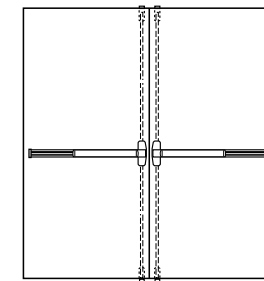

Two concealed vertical cables/rods

Outside Trim Operation

Trim Operation Lever or Knob

Standard



Key locks and unlocks lever or knob. e.g., 996L (Classroom)

Night Latch



Key retracts latch bolt. Lever or knob is rigid. Use NL suffix, e.g., 996LNL. (Storeroom)

Blank Escutcheon

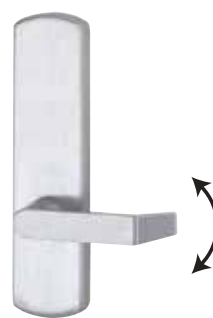

Lever or knob always active. Use BE suffix, e.g., 996L-BE. (Passage)

Dummy



Lever or knob rigid for pull operation. Use DT suffix, e.g., 996L-DT.

996L Breakaway™ Lever



The 996L Breakaway trim has become the standard lever trim offering on the 98L/99L Series devices. The Breakaway design is especially effective in areas where vandalism to door hardware is a problem. The design intent is to discourage costly repairs from becoming necessary. The Breakaway feature is not available on the NL (night-latch) or DT (dummy trim) versions.

374T/376T Series Thumbturn Control



Standard operation, key locks and unlocks thumbturn. Optional operation, key unlocks thumbturn, re-locks when key is removed. This operation is created by changing the cylinder plate included with control. Use 1 1/4" mortise cylinder with a straight cam. Schlage cam reference B502-191. Use with a pull trim (990DT pictured).

Decorative Levers



M51
Knurling available



M52
Knurling available



M53



M54



M55



M56



M57 ..



M61
(Handed)



M62 ..
(Handed)



M63
(Handed)



M81
Knurling available



M82



M83



M84



M85
(Handed)

.. Available in Stainless Steel substrate ONLY.

Standard Levers



01



02
Knurling available



03*
Knurling available



05



06*
Default lever
Knurling available



07



12
(Handed)



16
(Omega)



17*
Knurling available



18



ACC
(Accent)
(Handed)



AST
(Asti)
(Handed)



MER
(Merano)
(Handed)



STA
(St. Annes)
(Handed)



LAT*
Latitude



LON*
Longitude

*Available in Stainless Steel - specify SS when ordering



98 and 99 rim exit devices for all types of single and double doors with mullion, UL listed for Panic Exit Hardware. Devices are ANSI A156.3 – 2001 Grade 1. The 98 device has a smooth mechanism case and the 99 device has a grooved case. The rim device is non-handed except when the following device options are used: SD (Special Dogging), -2 (Double Cylinder) or SS (Signal Switch). See Opposite page for available outside trim and device functions. Covers stock hollow metal doors with 86 or 161 cutouts on single doors (may cover cutouts on pairs – consult template).

Finishes – US3, US3A, US4, US4A, US10, US26, US26D, US26D-AM Antimicrobial, US28, 313, 315 & 643E. US15 and US32D available with 98 Series only.

Hex key dogging comes standard on 98/99 Rim Exit Devices



Specifications	
Device Functions	Device ships EO/DT/NL. Field selectable. For TP, K or L remove NL drive screw from device.
Device Lengths	3' 2'4" to 3' (711mm to 914 mm) Door Size 4' 2'10" to 4' (864 mm to 1219 mm) Door Size
Device Centerline from Finished Floor	39 ¹³ / ₁₆ " (1011 mm) 39 ¹ / ₁₆ " (1008 mm) with Mullion
Center Case Dimensions	8" x 2 ³ / ₄ " x 2 ³ / ₈ " (203mm x 70mm x 60mm)
Mechanism Case Dimensions	2 ¹ / ₄ " x 2 ¹ / ₄ " (57mm x 57mm)
Projection	Pushbar Neutral – 3 ¹³ / ₁₆ " (97 mm) Pushbar Depressed – 3 ¹ / ₁₆ " (78 mm)
Latch Bolt	Deadlocking, 3/4" (19mm) throw
Fasteners & Sex Bolts (SNB)	Includes screw pack for 1 ³ / ₄ " (44mm) and 2 ¹ / ₄ " (57mm) thick metal or wood doors. Optional 425 SNB available, see page 9 for quantities.
Electric Options	LX Latchbolt Monitor Switch RX Pushpad Monitor Switch RX2 Double Pushpad Monitor Switch E Electric Locking & Unlocking Trim EL Electric Latch Retraction QEL Quiet Electric Latch Retraction SS Signal Switch CX Chexit Delayed Exit ALK Alarm Exit Kit WP-RX Waterproof Request to Exit
Mechanical Options	-2 Double Cylinder GBK Glass Bead Kit PN Pneumatic Latch Retraction XP Extra Protection SNB Sex Bolts SEC Security Screws
Dogging Feature	Hex key dogging standard
Dogging Options	CD Cylinder Dogging SD Special Center Case Dogging LD Less Dogging DI Dogging Indicator CI Cylinder Dogging Indicator
Strikes	299 – Dull Black

XP
Extra Protection
• 90° latch-to-strike contact
• Force resistance of 2,000+ lbs.

E (E996L)
Electrified Breakaway Lever
• Electrified remote locking/unlocking
• Standard in fail safe condition

QEL
Quiet Electric Latch Retraction
• Bolt retraction via switch
• Converts exit door to push-pull operation

CD
Cylinder Dogging
• Replaces hex key dogging
• Requires standard 1¹/₄" mortise cylinder

CX
Chexit Delayed Exit
• Meets NFPA 101 requirements
• Self-contained controls, locking, alarm

RX
Pushpad Monitor Switch
• Signals use of an opening
• SPDT switch to monitor pushpad

EL
Electric Latch Retraction
• Enables remote unlatching
• Alternative to manual dogging



ALK
Alarm Exit Kit
• Unauthorized opening triggers 85-decibel horn
• Set in armed or disarmed mode by key





PN
Pneumatic Latch Retraction
• For areas where electrical devices banned
• Special linkage for mechanical or pneumatic dogging

BRA, EMB, KN, SG
Braille, Embossed and Knurled Touchpads
• Braille touchpad embossed with "Caution Stairwell"
• Other messages available by special order

98/99 Rim Exit Device

Standard Trim

	EO	DT	NL	NL-OP
	No Outside Trim Exit only	 Dummy Trim Pull When Dogged	 Night Latch Key Retracts Latchbolt	 Night Latch Key Retracts Latchbolt Optional Pull Required
Product Description	98EO 99EO	98DT 99DT	98NL 99NL	98NL-OP 99NL-OP
Trim Description	—	990DT	990NL-R/V	110NL-MD 110NL-WD
Escutcheon Plate Size	—	3" x 14 ³ / ₁₆ " x ³ / ₃₂ " (76x360x2mm)	3" x 14 ³ / ₁₆ " x ³ / ₃₂ " (76x360x2mm)	—
Pull Center to Center	—	5 ¹ / ₂ " (140mm)	5 ¹ / ₂ " (140mm)	—
Projection	—	2" (51mm)	2" (51mm)	—
ANSI Function	01	02	03	03
Cylinder Type	—	—	Rim	Rim
Handing	—	—	—	—
Optional Trim	x990EO x996EO	x996K-DT x996L-DT x696DT x697DT	x996K-NL x996L-NL x696NL x697NL	
Optional #425 Sex Bolt Quantity for Device	6	2	2	6

	L	L-NL	L-BE	L-DT
	 Lever Key Locks & Unlocks	 Lever - Night Latch Key Retracts Latchbolt	 Lever - Blank Escutcheon Always operable (No Cylinder)	 Lever Dummy Trim Pull When Dogged
Product Description	98L 99L	98L-NL 99L-NL	98L-BE 99L-BE	98L-DT 99L-DT
Trim Description	996L-R/V*	996L-NL-R/V	996L-BE-R/V*	996L-DT
Escutcheon Plate Size	2 ³ / ₄ " X 10 ³ / ₄ " X ²⁷ / ₃₂ " (70x273x21mm)	2 ³ / ₄ " X 10 ³ / ₄ " X ²⁷ / ₃₂ " (70x273x21mm)	2 ³ / ₄ " X 10 ³ / ₄ " X ²⁷ / ₃₂ " (70x273x21mm)	2 ³ / ₄ " X 10 ³ / ₄ " X ²⁷ / ₃₂ " (70x273x21mm)
Pull Center to Center	—	—	—	—
Projection	2 ⁷ / ₈ " (73mm)	2 ⁷ / ₈ " (73mm)	2 ⁷ / ₈ " (73mm)	2 ⁷ / ₈ " (73mm)
ANSI Function	08	03	14	02
Cylinder Type	Rim	Rim	—	—
Handing	Handed/Reversible	Handed/Reversible	Handed/Reversible	Handed/Reversible
Optional #425 SNB Quantity for Device	2	2	2	2

* Electrified lever operation available

Notes

98-F/99-F Rim Fire Exit Device

VON DUPRIN



The 299F Strike ships standard, optional strikes available

499F Strike with 9854/9954 Mullion

98-F and 99-F rim fire exit devices for all types of single doors up to 4' x 10' (1219mm x 3048mm) or 8' x 10' (2438mm x 3048mm) double doors with 9954 or 9854 mullion, UL listed for Fire Exit Hardware. See page 61 for detailed information on UL listed fire exit hardware label and door opening size information. Devices are ANSI A156.3 – 2001 Grade 1. The 98-F device has a smooth mechanism case and the 99-F device has a grooved case. The rim device is non-handed except when the following device options are used: -2 (Double Cylinder) or SS (Signal Switch). See Opposite page for available outside trim and device functions.

Finishes – US3, US3A, US4, US4A, US10, US26, US26D, US26D-AM Antimicrobial, US28, 313, 315 & 643E. US15 and US32D available with 98 Series only.

Specifications

Device Functions	Device ships EO/DT/NL. Field selectable. For TP, K or L remove NL drive screw from device.
Device Lengths	3' 2'4" to 3' (711mm to 914 mm) Door Size 4' 2'10" to 4' (864 mm to 1219 mm) Door Size
Device Centerline from Finished Floor	39 ¹³ / ₁₆ " (1011 mm) 39 ¹ / ₁₆ " (1008 mm) with Mullion
Center Case Dimensions	8" x 2 ³ / ₄ " x 2 ³ / ₈ " (203mm x 70mm x 60mm)
Mechanism Case Dimensions	2 ¹ / ₄ " x 2 ¹ / ₄ " (57mm x 57mm)
Projection	Pushbar Neutral – 3 ¹³ / ₁₆ " (97 mm) Pushbar Depressed – 3 ¹ / ₁₆ " (78 mm)
Latch Bolt	Deadlocking, ³ / ₄ " (19mm) throw
Fasteners & Sex Bolts (SNB)	Includes screw pack for 1 ³ / ₄ " (44mm) and 2 ¹ / ₄ " (57mm) thick metal or wood doors. Optional 425 SNB available for metal doors. 425 & 825 SNB <i>required</i> on wood doors without SLM blocking. See page 11 for quantities.
Electric Options	LX Latchbolt Monitor Switch RX Pushpad Monitor Switch RX2 Double Pushpad Monitor Switch E Electric Locking and Unlocking Trim EL Electric Latch Retraction QEL Quiet Electric Latch Retraction SS Signal Switch CX Chexit Delayed Exit ALK Alarm Exit Kit WP-RX Waterproof Request to Exit
Mechanical Options	-2 Double Cylinder GBK Glass Bead Kit PN Pneumatic Latch Retraction XP Extra Protection SNB Sex Bolts SEC Security Screws SLM Special Laminate Material Blocking
Dogging Option	No Mechanical Dogging. EL and QEL option available
Strikes	299F – Dull Black, 499F with Mullions

XP
Extra Protection

- 90° latch-to-strike contact
- Force resistance of 2,000+ lbs.

E (E996L)
Electrified Breakaway Lever

- Electrified remote locking/unlocking
- Standard in fail safe condition

EL
Electric Latch Retraction

- Enables remote unlatching
- Alternative to manual dogging

RX
Pushpad Monitor Switch

- Signals use of an opening
- SPDT switch to monitor pushpad

QEL
Quiet Electric Latch Retraction

- Bolt retraction via switch
- Converts exit door to push-pull operation

ALK
Alarm Exit Kit

- Unauthorized opening triggers 85-decibel horn
- Set in armed or disarmed mode by key

CX
Chexit Delayed Exit

- Meets NFPA 101 requirements
- Self-contained controls, locking, alarm

SG
Safety Glow

- Shows exit door location in darkness or smoke
- Developed to meet MEA standards

PN
Pneumatic Latch Retraction



- For areas where electrical devices banned
- Special linkage for mechanical or pneumatic dogging





BRA, EMB, KN, SG
Braille, Embossed and Knurled Touchpads

- Braille touchpad embossed with "Caution Stairwell"
- Other messages available by special order

98-F/99-F Rim Fire Exit Device

Standard Trim

	EO	DT	NL	NL-OP
				
	Exit only	Dummy Trim Pull When Dogged (Not recommended for fire device)	Night Latch Key Retracts Latchbolt	Night Latch Key Retracts Latchbolt Optional Pull Required
Product Description	98EO-F 99EO-F	— —	98NL-F 99NL-F	98NL-OP-F 99NL-OP-F
Trim Description	—	990DT	990NL-R/V	110NL-MD 110NL-WD
Escutcheon Plate Size	—	3" x 14 ³ / ₁₆ " x ³ / ₃₂ " (76x360x2mm)	3" x 14 ³ / ₁₆ " x ³ / ₃₂ " (76x360x2mm)	—
Pull Center to Center	—	5 ¹ / ₂ " (140mm)	5 ¹ / ₂ " (140mm)	—
Projection	—	2" (51mm)	2" (51mm)	—
ANSI Function	01	02	03	03
Cylinder Type	—	—	Rim	Rim
Handing	—	—	—	—
Optional Trim	x990EO x996EO	x996K-DT x996L-DT x696DT x697DT	x996K-NL x996L-NL x696NL x697NL	
#425 SNB optional - HMD req. WD w/o SLM pkg.	6	2	2	6
#825 SNB req. WD w/o SLM pkg.	2 (if using trim)	2	2	2
#425 SNB req. w/ 499F	2	2	2	2

	L	L-NL	L-BE	L-DT
				
	Lever Key Locks & Unlocks	Lever - Night Latch Key Retracts Latchbolt	Lever - Blank Escutcheon Always operable (No Cylinder)	Lever Dummy Trim Pull When Dogged (Not recommended for fire device)
Product Description	98L-F 99L-F	98L-NL-F 99L-NL-F	98L-BE-F 99L-BE-F	— —
Trim Description	996L-R/V*	996L-NL-R/V	996L-BE-R/V*	996L-DT-R/V
Escutcheon Plate Size	2 ³ / ₄ " X 10 ³ / ₄ " X ²⁷ / ₃₂ " (70x273x21mm)	2 ³ / ₄ " X 10 ³ / ₄ " X ²⁷ / ₃₂ " (70x273x21mm)	2 ³ / ₄ " X 10 ³ / ₄ " X ²⁷ / ₃₂ " (70x273x21mm)	2 ³ / ₄ " X 10 ³ / ₄ " X ²⁷ / ₃₂ " (70x273x21mm)
Pull Center to Center	—	—	—	—
Projection	2 ⁷ / ₈ " (73mm)	2 ⁷ / ₈ " (73mm)	2 ⁷ / ₈ " (73mm)	2 ⁷ / ₈ " (73mm)
ANSI Function	08	09	14	02
Cylinder Type	Rim	Rim	—	—
Handing	Handed/Reversible	Handed/Reversible	Handed/Reversible	Handed/Reversible
#425 SNB optional - HMD req. WD w/o SLM pkg.	2	2	2	2
#825 SNB req. WD w/o SLM pkg.	2 (if using trim)	2	2	2
#425 SNB req. w/ 499F	2	2	2	2

* Electrified lever operation available

Notes

9875/9975 Mortise Lock Device

VON DUPRIN.



Hex key dogging comes standard on 9875/9975 Mortise Lock Devices



7500 Mortise Lock

575 Strike

9875/9975 mortise lock device for all types of single or double doors, UL listed for Panic Exit Hardware. Devices are ANSI A156.3 – 2001 Grade 1. Fits stock hollow metal doors with 86 cutout and door stiles as narrow as 4 3/4" (121mm). The 9875 device has a smooth mechanism case and the 9975 device has a grooved case. The mortise lock device is non-handed except when the following device options are used: -2 (Double Cylinder) or SS (Signal Switch). See Opposite page for available outside trim and device functions.

The 7500 Mortise lock is equipped with a 3/4" (19mm) anti-friction latch bolt which is field reversible without removing the lock from the door. It has a non-handed auxiliary bolt for deadlocking and a faceplate with an adjustable bevel.

Finishes – US3, US3A, US4, US4A, US10, US26, US26D, US26D-AM Antimicrobial, US28, 313, 315 & 643E. US15 and US32D available with 98 Series only.

Specifications	
Device Functions	Device ships EO/DT/NL. Field selectable. For TP, K or L adjust NL drive screw in mortise lock.
Device Lengths	3' 2'4" to 3' (711mm to 914 mm) Door Size 4' 2'10" to 4' (864 mm to 1219 mm) Door Size
Device Centerline from Finished Floor	39 9/16" (1006 mm)
Center Case Dimensions	8" x 2 3/4" x 2 3/8" (203mm x 70mm x 60mm)
Mechanism Case Dimensions	2 1/4" x 2 1/4" (57mm x 57mm)
Projection	Pushbar Neutral – 3 13/16" (97 mm) Pushbar Depressed – 3 1/16" (78 mm)
Fasteners & Sex Bolts (SNB)	Includes screw pack for 1 3/4" (44mm) and 2 1/4" (57mm) thick metal or wood doors. Optional 425 SNB available, see page 13 for quantities.
Electric Options	RX Pushpad Monitor Switch RX2 Double Pushpad Monitor Switch E Electric Locking & Unlocking EL Electric Latch Retraction QEL Quiet Electric Latch Retraction SS Signal Switch CX Chexit Delayed Exit ALK Alarm Exit Kit WP-RX Waterproof Request to Exit
Mechanical Options	-2 Double Cylinder GBK Glass Bead Kit PN Pneumatic Latch Retraction SNB Sex Bolts SEC Security Screws
Dogging Feature	Hex key dogging standard
Dogging Options	CD Cylinder Dogging LD Less Dogging DI Dogging Indicator CI Cylinder Dogging Indicator
Strikes	575 – Dull Black

QEL
Quiet Electric Latch Retraction

- Bolt retraction via switch
- Converts exit door to push-pull operation

CD
Cylinder Dogging

- Replaces hex key dogging
- Requires standard 1 1/4" mortise cylinder

CX
Chexit Delayed Exit

- Meets NFPA 101 requirements
- Self-contained controls, locking, alarm

RX
Pushpad Monitor Switch

- Signals use of an opening
- SPDT switch to monitor pushpad

EL
Electric Latch Retraction

- Enables remote unlatching
- Alternative to manual dogging

ALK
Alarm Exit Kit

- Unauthorized opening triggers 85-decibel horn
- Set in armed or disarmed mode by key

E (E7500)
Electric Mortise Lock Device

- Remains latched while unlocked
- Remote electrical control

SG
Safety Glow

- Shows exit door location in darkness or smoke
- Developed to meet MEA standards

PN
Pneumatic Latch Retraction



- For areas where electrical devices banned
- Special linkage for mechanical or pneumatic dogging





SS 7500
Signal Switch

- Signals unauthorized use of an opening
- Switch makes latch bolt tamper-resistant

9875/9975 Mortise Lock Device

Standard Trim

	EO	DT	NL	HL
				
	Exit only	Dummy Trim Pull When Dogged (Not recommended for fire device)	Night Latch Key Retracts Latchbolt	Hospital Latch Key Locks & Unlocks
Product Description	9875EO 9975EO	9875DT 9975DT	9875NL 9975NL	9875HL 9975HL
Trim Description	—	990DT	990NL-M	HL6M
Escutcheon Plate Size	—	3" x 14 ³ / ₁₆ " x ³ / ₃₂ " (76x360x2mm)	3" x 14 ³ / ₁₆ " x ³ / ₃₂ " (76x360x2mm)	2 ⁹ / ₁₆ " x 5 ¹ / ₂ " x 2 ⁵ / ₈ " (65x140x67mm)
Pull Center to Center	—	5 ¹ / ₂ " (140mm)	5 ¹ / ₂ " (140mm)	—
Projection	—	2" (51mm)	2" (51mm)	2 ⁵ / ₈ " (67mm)
ANSI Function	01	02	03	—
Cylinder Type	—	—	1 ¹ / ₄ " Mortise	1 ¹ / ₄ " Mortise
Optional Trim	x990EO x996EO	x996K-DT x996L-DT) x696DT x697DT	x996K-NL x996L-NL x696NL x697NL	
Handing	—	—	—	—
Optional #425 SNB Quantity for Device	6	2	2	2

	L	L-NL	L-BE	L-DT
				
	Lever Key Locks & Unlocks	Lever - Night Latch Key Retracts Latchbolt	Lever - Blank Escutcheon Always operable (No Cylinder)	Lever Dummy Trim Pull When Dogged
Product Description	9875L 9975L	9875L-NL 9975L-NL	9875L-BE 9975L-BE	9875L-DT 9975L-DT
Trim Description	996L-M*	996L-NL-M	996L-BE-M*	996L-DT-M
Escutcheon Plate Size	2 ³ / ₄ " X 10 ³ / ₄ " X ²⁷ / ₃₂ " (70x273x21mm)	2 ³ / ₄ " X 10 ³ / ₄ " X ²⁷ / ₃₂ " (70x273x21mm)	2 ³ / ₄ " X 10 ³ / ₄ " X ²⁷ / ₃₂ " (70x273x21mm)	2 ³ / ₄ " X 10 ³ / ₄ " X ²⁷ / ₃₂ " (70x273x21mm)
Pull Center to Center	—	—	—	—
Projection	2 ⁷ / ₈ " (73mm)	2 ⁷ / ₈ " (73mm)	2 ⁷ / ₈ " (73mm)	2 ⁷ / ₈ " (73mm)
ANSI Function	08	03	14	02
Cylinder Type	1 ¹ / ₄ " Mortise	1 ¹ / ₄ " Mortise	—	—
Handing	Handed/Reversible	Handed/Reversible	Handed/Reversible	Handed/Reversible
Optional #425 SNB Quantity for Device	2	2	2	2

* Electrified lever operation available

Notes

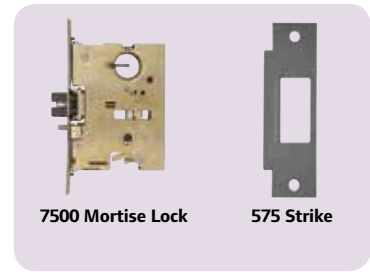

9875-F/9975-F fire exit mortise lock devices for all types of single doors up to 4' x 10' (1219mm x 3048mm) or 8' x 10' (2438mm x 3048mm) double doors installations, UL listed for Fire Exit Hardware; See page 61 for detailed information on UL listed fire exit hardware label and door opening size information. Devices are ANSI A156.3 – 2001 Grade 1. Fits door stiles as narrow as 4¾" (121mm). The 9875-F device has a smooth mechanism case and the 9975-F device has a grooved case. The mortise lock device is non-handed except when the following device options are used: -2 (Double Cylinder) or SS (Signal Switch) devices. See Opposite page for available outside trim and functions.

The 7500 Mortise lock is equipped with a ¾" (19mm) anti-friction latch bolt which is field reversible without removing the lock from the door. It has a non-handed auxiliary bolt for deadlocking and a faceplate with an adjustable bevel.

Finishes – US3, US3A, US4, US4A, US10, US26, US26D, US26D-AM Antimicrobial, US28, 313, 315 & 643E. US15 and US32D available with 98 Series only.

Specifications	
Device Functions	Device ships EO/DT/NL. Field selectable. TP, K or L available with NL screw.
Device Lengths	3' 2'4" to 3' (711 mm to 914 mm) Door Size 4' 2'10" to 4' (864 mm to 1219 mm) Door Size
Device Centerline from Finished Floor	39 ⁵ / ₈ " (1006 mm)
Center Case Dimensions	8" x 2 ³ / ₄ " x 2 ³ / ₈ " (203mm x 70mm x 60mm)
Mechanism Case Dimensions	2 ¹ / ₄ " x 2 ¹ / ₄ " (57mm x 57mm)
Projection	Pushbar Neutral – 3 ¹³ / ₁₆ " (97 mm) Pushbar Depressed – 3 ¹ / ₁₆ " (78 mm)
Fasteners & Sex Bolts (SNB)	Includes screw pack for 1 ³ / ₄ " (44mm) and 2 ¹ / ₄ " (57mm) thick metal or wood doors. Optional 425 SNB available for metal doors. 425 SNB <i>required</i> on wood doors without SLM blocking. See page 15 for quantities.
Electric Options	RX Pushpad Monitor Switch RX2 Double Pushpad Monitor Switch E Electric Locking & Unlocking EL Electric Latch Retraction QEL Quiet Electric Latch Retraction SS Signal Switch CX Chexit Delayed Exit ALK Alarm Exit Kit WP-RX Waterproof Request to Exit
Mechanical Options	-2 Double Cylinder GBK Glass Bead Kit PN Pneumatic Latch Retraction SNB Sex Bolts SEC Security Screws SLM Special Laminate Material Blocking
Dogging Option	No mechanical dogging. EL and QEL option available.
Strikes	575 – Dull Black

QEL
Quiet Electric Latch Retraction
 • Bolt retraction via switch
 • Converts exit door to push-pull operation

RX
Pushpad Monitor Switch
 • Signals use of an opening
 • SPDT switch to monitor pushpad

CX
Chexit Delayed Exit
 • Meets NFPA 101 requirements
 • Self-contained controls, locking, alarm

ALK
Alarm Exit Kit
 • Unauthorized opening triggers 85-decibel horn
 • Set in armed or disarmed mode by key

EL
Electric Latch Retraction
 • Enables remote unlatching
 • Alternative to manual dogging

SG
Safety Glow
 • Shows exit door location in darkness or smoke
 • Developed to meet MEA standards

E (E7500)
Electric Mortise Lock Device
 • Remains latched while unlocked
 • Remote electrical control



SS 7500
Signal Switch
 • Signals unauthorized use of an opening
 • Switch makes latch bolt tamper-resistant





PN
Pneumatic Latch Retraction
 • For areas where electrical devices banned
 • Special linkage for mechanical or pneumatic dogging

BRA, EMB, KN, SG
Braille, Embossed and Knurled Touchpads
 • Braille touchpad embossed with "Caution Stairwell"
 • Other messages available by special order

9875-F/9975-F Mortise Lock Fire Exit Device

Standard Trim

	EO	DT	NL	HL
	Exit only	 Dummy Trim Pull When Dogged	 Night Latch Key Retracts Latchbolt	 Hospital Latch Key Locks & Unlocks
Product Description	9875EO-F 9975EO-F	— —	9875NL-F 9975NL-F	9875HL-F 9975HL-F
Trim Description	—	990DT	990NL-M	HL6M
Escutcheon Plate Size	—	3" x 14 ³ / ₁₆ " x ³ / ₃₂ " (76x360x2mm)	3" x 14 ³ / ₁₆ " x ³ / ₃₂ " (76x360x2mm)	2 ⁹ / ₁₆ " x 5 ¹ / ₂ " x 2 ⁵ / ₈ " (65x140x67mm)
Pull Center to Center	—	5 ¹ / ₂ " (140mm)	5 ¹ / ₂ " (140mm)	—
Projection	—	2" (51mm)	2" (51mm)	2 ⁵ / ₈ " (67mm)
ANSI Function	01	02	03	—
Cylinder Type	—	—	1 ¹ / ₄ " Mortise	1 ¹ / ₄ " Mortise
Handing	—	—	—	—
Optional Trim	x990EO x996EO	x996K-DT x996L-DT x696DT x697DT	x996K-NL x996L-NL x696NL x697NL	
Optional #425 SNB Quantity for Device	6	2	2	2

	L	L-NL	L-BE	L-DT
	 Lever Key Locks & Unlocks	 Lever - Night Latch Key Retracts Latchbolt	 Lever - Blank Escutcheon Always operable (No Cylinder)	 Lever Dummy Trim Pull When Dogged (Not recommended for fire device)
Product Description	9875L-F 9975L-F	9875L-NL-F 9975L-NL-F	9875L-BE-F 9975L-BE-F	— —
Trim Description	996L-M*	996L-NL-M	996L-BE-M*	996L-DT
Escutcheon Plate Size	2 ³ / ₄ " X 10 ³ / ₄ " X ²⁷ / ₃₂ " (70x273x21mm)	2 ³ / ₄ " X 10 ³ / ₄ " X ²⁷ / ₃₂ " (70x273x21mm)	2 ³ / ₄ " X 10 ³ / ₄ " X ²⁷ / ₃₂ " (70x273x21mm)	2 ³ / ₄ " X 10 ³ / ₄ " X ²⁷ / ₃₂ " (70x273x21mm)
Pull Center to Center	—	—	—	—
Projection	2 ⁷ / ₈ " (73mm)	2 ⁷ / ₈ " (73mm)	2 ⁷ / ₈ " (73mm)	2 ⁷ / ₈ " (73mm)
ANSI Function	08	03	14	02
Cylinder Type	1 ¹ / ₄ " Mortise	1 ¹ / ₄ " Mortise	—	—
Handing	Handed/Reversible	Handed/Reversible	Handed/Reversible	Handed/Reversible
Optional #425 SNB Quantity for Device	2	2	2	2

* Electrified lever operation available

Notes

9827/9927 Surface Mounted Vertical Rod Device

VON DUPRIN.



Hex key dogging comes standard on 9827/9927

9827/9927 surface mounted vertical rod device for all types of single or double doors, UL listed for Panic Exit Hardware. Devices are ANSI A156.3 – 2001 Grade 1. Covers stock hollow metal doors with 86 or 161 cutouts. The 9827 device has a smooth mechanism case and the 9927 device has a grooved case. The surface vertical rod device is non-handed except when the following device options are used: SD (Special Dogging), or SS (Signal Switch). See Opposite page for available outside trim and functions.

Vertical rod and latch guards are available to protect the bottom rod of the exit device from damage by impacts of carts or gurneys passing through doors.

Finishes – US3, US3A, US4, US4A, US10, US26, US26D, US26D-AM Antimicrobial, US28, 313, 315 & 643E. US15 and US32D available with 98 Series only.



Specifications

Device Functions	Device ships EO/DT/NL. Field selectable. For TP, K or L remove NL drive screw from device.	
Device Lengths	2'	2' (610mm) Door Size (shipped less UL label)
	3'	2'4" to 3' (711mm to 914 mm) Door Size
	4'	2'10" to 4' (864 mm to 1219 mm) Door Size
Device Centerline from Finished Floor	39 ⁵ / ₈ " (1006 mm)	
Center Case Dimensions	8" x 2 ³ / ₄ " x 2 ³ / ₈ " (203mm x 70mm x 60mm)	
Mechanism Case Dimensions	2 ¹ / ₄ " x 2 ¹ / ₄ " (57mm x 57mm)	
Projection	Pushbar Neutral – 3 ¹³ / ₁₆ " (97 mm) Pushbar Depressed – 3 ¹ / ₁₆ " (78 mm)	
Latch Bolt	Deadlocking Anti-friction Top & Bottom Bolt, 5/8" (16mm) throw	
Door Undercut	1/4" (7mm) recommended	
Top & Bottom Latch Case	4 ¹ / ₂ " x 2 ¹ / ₈ " x 1 ¹ / ₂ " (114mm x 54mm x 38mm)	
Vertical Rods	1/2" square tubing, standard rods accommodate 7' (2134mm) doors. Top rod length: 34 ¹⁵ / ₁₆ " (887mm); Bottom rod length: 31 ¹ / ₂ " (794mm) Extension rods available in 1' (205mm) or 3' (914mm) for doors over 7'. One piece top rod is available for 8' (2438mm) and 10' (3048mm) doors.	
Fasteners & Sex Bolts (SNB)	Includes screw pack for 1 ³ / ₄ " (44mm) to 2 ¹ / ₄ " (57mm) thick metal or wood doors, and 325 SNB for top and bottom latch. Optional 425 SNB available.	
Electric Options	LX	Latchbolt Monitor Switch
	RX	Pushpad Monitor Switch
	RX2	Double Pushpad Monitor Switch
	EL	Electric Latch Retraction
	QEL	Quiet Electric Latch Retraction
	SS	Signal Switch
	CX	Chexit Delayed Exit
	ALK	Alarm Exit Kit
	PN	Pneumatic Latch Retraction
	LBR	Less Bottom Rod
	WP-RX	Waterproof Request to Exit
Mechanical Options	GBK	Glass Bead Kit
	PL	Pullman Latch
	WS	Tornado and Hurricane Tested
	SNB	Sex Bolts
	SEC	Security Screws
Dogging Feature	Hex key dogging standard	
Dogging Options	CD	Cylinder Dogging
	SD	Special Center Case Dogging
	LD	Less Dogging
	DI	Dogging Indicator
	CI	Cylinder Dogging Indicator
Strikes	Top - 299 – Dull Black, Bottom – 248L4 & 304L - Unfinished	

WS
Windstorm

- Severe weather certified/tested
- FEMA and ICC compliant

CD
Cylinder Dogging

- Replaces hex key dogging
- Requires standard 1¹/₄" mortise cylinder

QEL
Quiet Electric Latch Retraction

- Bolt retraction via switch
- Converts exit door to push-pull operation

RX
Pushpad Monitor Switch

- Signals use of an opening
- SPDT switch to monitor pushpad

EL
Electric Latch Retraction

- Enables remote unlatching
- Alternative to manual dogging

ALK
Alarm Exit Kit

- Unauthorized opening triggers 85-decibel horn
- Set in armed or disarmed mode by key

PN
Pneumatic Latch Retraction

- For areas where electrical devices banned
- Special linkage for mechanical or pneumatic dogging

CX
Chexit Delayed Exit

- Meets NFPA 101 requirements
- Self-contained controls, locking, alarm

E (E 996L)
Electrified Breakaway Lever





- Electrified remote locking/unlocking
- Standard in fail safe condition

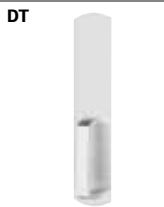
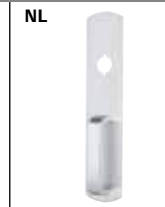

SS
Signal Switch

- Signals unauthorized use of an opening
- Switch makes latch bolt tamper-resistant

9827/9927 Surface Mounted Vertical Rod Device

Standard Trim

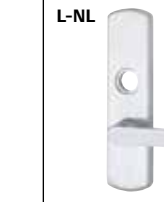
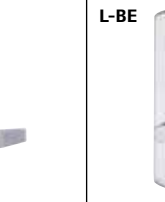
	EO	DT	NL	NL-OP	TL	TL-BE
						
	Exit only	Dummy Trim Pull When Dogged	Night Latch Key Retracts Latchbolt	Night Latch Key Retracts Latchbolt Optional Pull Required	Thumbturn Key Locks & Unlocks (Use with DT Trim)	Thumbturn Blank Escutcheon Always Operable (No Cylinder) (Use with DT Trim)
Product Description	9827EO 9927EO	9827DT 9927DT	9827NL 9927NL	9827NL-OP 9927NL-OP	9827TL 9927TL	9827TL-BE 9927TL-BE
Trim Description	—	990DT	990NL-R/V	110NL-MD 110NL-WD	374T x 990DT	374T-BE x 990DT
Escutcheon Plate Size	—	3" x 14 ³ / ₁₆ " x ³ / ₃₂ " (76x360x2mm)	3" x 14 ³ / ₁₆ " x ³ / ₃₂ " (76x360x2mm)	—	1 ¹¹ / ₁₆ " x 7 ¹ / ₂ " x ⁷ / ₈ " (43x191x22mm)	1 ¹¹ / ₁₆ " x 7 ¹ / ₂ " x ⁷ / ₈ " (43x191x22mm)
Pull Center to Center	—	5 ¹ / ₂ " (140mm)	5 ¹ / ₂ " (140mm)	—	—	—
Projection	—	2" (51mm)	2" (51mm)	—	3 ¹ / ₄ " (83mm)	3 ¹ / ₄ " (83mm)
ANSI Function	01	02	03	03	11 or 12	16
Cylinder Type	—	—	Rim	Rim	1 ¹ / ₄ " Mortise	—
Handing	—	—	—	—	—	—
Optional Trim	x990EO x996EO	x996K-DT x996L-DT x696DT x697DT	x996K-NL x996L-NL x696NL x697NL			
Optional #425 SNB Quantity for Device	6	2	2	6	2	2

	L	L-NL	L-BE	L-DT
				
	Lever Key Locks & Unlocks	Lever - Night Latch Key Retracts Latchbolt	Lever - Blank Escutcheon Always operable (No Cylinder)	Lever Dummy Trim Pull When Dogged
Product Description	9827L 9927L	9827L-NL 9927L-NL	9827L-BE 9927L-BE	9827L-DT 9927L-DT
Trim Description	996L-R/V*	996L-NL-R/V	996L-BE-R/V*	996L-DT
Escutcheon Plate Size	2 ³ / ₄ " X 10 ³ / ₄ " X ²⁷ / ₃₂ " (70x273x21mm)	2 ³ / ₄ " X 10 ³ / ₄ " X ²⁷ / ₃₂ " (70x273x21mm)	2 ³ / ₄ " X 10 ³ / ₄ " X ²⁷ / ₃₂ " (70x273x21mm)	2 ³ / ₄ " X 10 ³ / ₄ " X ²⁷ / ₃₂ " (70x273x21mm)
Pull Center to Center	—	—	—	—
Projection	2 ⁷ / ₈ " (73mm)	2 ⁷ / ₈ " (73mm)	2 ⁷ / ₈ " (73mm)	2 ⁷ / ₈ " (73mm)
ANSI Function	08	03	14	02
Cylinder Type	Rim	Rim	—	—
Handing	Handed/Reversible	Handed/Reversible	Handed/Reversible	Handed/Reversible
Optional #425 SNB Quantity for Device	2	2	2	2

* Electrified lever operation available

Notes

9827-F/9927-F Surface Mounted Vertical Rod Fire Device **VON DUPRIN**

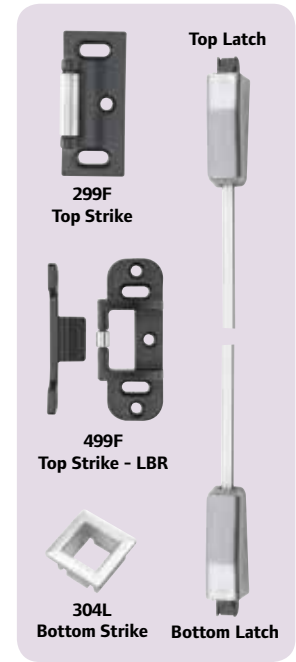

9827-F/9927-F fire exit surface mounted vertical rod device pairs of doors up to 8' x 10' (2438mm x 3048mm), UL listed for Fire Exit Hardware. See page 68 for detailed information on UL listed fire exit hardware label and door opening size information. Devices are ANSI A156.3 – 2001 Grade 1. The 9827-F device has a smooth mechanism case and the 9927-F device has a grooved case. The surface vertical rod device is non-handed except when the following device options are used: SS (Signal Switch). See Opposite page for available outside trim and device functions.

Vertical rod and latch guards are available to protect the bottom rod of the exit device from damage by impacts of carts or gurneys passing through doors. Rod and latch guards can be used on hollow metal or tin clad composite fire doors.

Finishes – US3, US4, US10, US26, US26D, US28 & 313. US15 and US32D available with 98 Series only.

Specifications

Device Functions	Device ships EO/DT/NL. Field selectable. For TP, K or L remove NL drive screw from device.
Device Lengths	2' 2' (610mm) Door Size (shipped less UL label) 3' 2'4" to 3' (711mm to 914 mm) Door Size 4' 2'10" to 4' (864 mm to 1219 mm) Door Size
Device Centerline from Finished Floor	39 ⁵ / ₈ " (1006 mm)
Center Case Dimensions	8" x 2 ³ / ₄ " x 2 ³ / ₈ " (203mm x 70mm x 60mm)
Mechanism Case Dimensions	2 ¹ / ₄ " x 2 ¹ / ₄ " (57mm x 57mm)
Projection	Pushbar Neutral – 3 ¹ / ₁₆ " (97 mm) Pushbar Depressed – 3 ¹ / ₁₆ " (78 mm)
Latch Bolt	Deadlocking Anti-friction Top & Bottom Bolt, ⁵ / ₈ " (16mm) throw
Door Undercut	¹ / ₄ " (7mm) maximum
Top & Bottom Latch Case	4 ¹ / ₂ " x 2 ¹ / ₈ " x 1 ¹ / ₂ " (114mm x 54mm x 38mm)
Vertical Rods	¹ / ₂ " square tubing, standard rods accommodate 7' (2134mm) doors. Top rod length: 34 ¹⁵ / ₁₆ " (887mm); Bottom rod length: 31 ¹ / ₂ " (794mm) Extension rods available in 1' (205mm) or 3' (914mm) for doors over 7'. One piece top rod is available for 8' (2438mm) and 10' (3048mm) doors.
Fasteners & Sex Bolts (SNB)	Includes screw pack for 1 ³ / ₄ " (44mm) to 2 ¹ / ₄ " (57mm) thick metal or wood doors, and 325 SNB for top and bottom latch. Optional 425 SNB available.
Electric Options	LX Latchbolt Monitor Switch RX Pushpad Monitor Switch RX2 Double Pushpad Monitor Switch E Electric Unlocking and Locking Trim EL Electric Latch Retraction QEL Quiet Electric Latch Retraction SS Signal Switch CX Chexit Delayed Exit ALK Alarm Exit Kit WP-RX Waterproof Request to Exit
Mechanical Options	GBK Glass Bead Kit PN Pneumatic Latch Retraction LBR Less Bottom Rod WS Tornado and Hurricane Tested SNB Sex Bolts SEC Security Screws SLM Special Laminate Material Blocking
Dogging Option	No mechanical dogging. EL and QEL option available
Strikes	Top - 299F (499F LBR) – Dull Black, Bottom – 304L - Unfinished

WS
Windstorm
• Severe weather certified/tested
• FEMA and ICC compliant

RX
Pushpad Monitor Switch
• Signals use of an opening
• SPDT switch to monitor pushpad

QEL
Quiet Electric Latch Retraction
• Bolt retraction via switch
• Converts exit door to push-pull operation

ALK
Alarm Exit Kit
• Unauthorized opening triggers 85-decibel horn
• Set in armed or disarmed mode by key

EL
Electric Latch Retraction
• Enables remote unlatching
• Alternative to manual dogging

CX
Chexit Delayed Exit
• Meets NFPA 101 requirements
• Self-contained controls, locking, alarm





PN
Pneumatic Latch Retraction
• For areas where electrical devices banned
• Special linkage for mechanical or pneumatic dogging





SG
Safety Glow
• Shows exit door location in darkness or smoke
• Developed to meet MEA standards

E (E 996L)
Electrified Breakaway Lever
• Electrified remote locking/unlocking
• Standard in fail safe condition

LBR
Less Bottom Rod
• Available with UL Fire Label
• For pairs of vertical rod devices

Standard Trim

	EO Exit only	DT  Dummy Trim Pull When Dogged (Not recommended for fire device)	NL  Night Latch Key Retracts Latchbolt	NL-OP  Night Latch Key Retracts Latchbolt Optional Pull Required	TL  Thumbturn Key Locks & Unlocks (Use with DT Trim)	TL-BE  Thumbturn Blank Escutcheon Always Operable (No Cylinder) (Use with DT Trim)
Product Description	9827EO-F 9927EO-F	— —	9827NL-F 9927NL-F	9827NL-OP-F 9927NL-OP-F	9827TL-F 9927TL-F	9827TL-BE-F 9927TL-BE-F
Trim Description	—	990DT	990NL-R/V	110NL-MD 110NL-WD	374T x 990DT	374T-BE x 990DT
Escutcheon Plate Size	—	3" x 14 ³ / ₁₆ " x ³ / ₃₂ " (76x360x2mm)	3" x 14 ³ / ₁₆ " x ³ / ₃₂ " (76x360x2mm)	—	1 ¹¹ / ₁₆ " x 7 ¹ / ₂ " x ⁷ / ₈ " (43x191x22mm)	1 ¹¹ / ₁₆ " x 7 ¹ / ₂ " x ⁷ / ₈ " (43x191x22mm)
Pull Center to Center	—	5 ¹ / ₂ " (140mm)	5 ¹ / ₂ " (140mm)	—	—	—
Projection	—	2" (51mm)	2" (51mm)	—	2" (51mm)	2" (51mm)
ANSI Function	01	02	03	03	11 or 12	16
Cylinder Type	—	—	Rim	Rim	1 ¹ / ₄ " Mortise	—
Handing	—	—	—	—	—	—
Optional Trim	x990EO x996EO	x996K-DT x996L-DT x696DT x697DT	x996K-NL x996L-NL x696NL x697NL			
Optional #425 SNB Quantity for Device	6	2	2	6	2	2

	L  Lever Key Locks & Unlocks	L-NL  Lever – Night Latch Key Retracts Latchbolt	L-BE  Lever – Blank Escutcheon Always operable (No Cylinder)	L-DT  Lever Dummy Trim Pull When Dogged (Not recommended for fire device)
Product Description	9827L-F 9927L-F	9827L-NL-F 9927L-NL-F	9827L-BE-F 9927L-BE-F	— —
Trim Description	996L-R/V*	996L-NL-R/V	996L-BE-R/V*	996L-DT
Escutcheon Plate Size	2 ³ / ₄ " X 10 ³ / ₄ " X ²⁷ / ₃₂ " (70x273x21mm)	2 ³ / ₄ " X 10 ³ / ₄ " X ²⁷ / ₃₂ " (70x273x21mm)	2 ³ / ₄ " X 10 ³ / ₄ " X ²⁷ / ₃₂ " (70x273x21mm)	2 ³ / ₄ " X 10 ³ / ₄ " X ²⁷ / ₃₂ " (70x273x21mm)
Pull Center to Center	—	—	—	—
Projection	2 ⁷ / ₈ " (73mm)	2 ⁷ / ₈ " (73mm)	2 ⁷ / ₈ " (73mm)	2 ⁷ / ₈ " (73mm)
ANSI Function	08	03	14	02
Cylinder Type	Rim	Rim	—	—
Handing	Handed/Reversible	Handed/Reversible	Handed/Reversible	Handed/Reversible
Optional #425 SNB Quantity for Device	2	2	2	2

* Electrified lever operation available

Notes

9857/9957 Three-Point Latching Device

VON DUPRIN.



Hex key dogging comes standard on 9857/9957 Three-Point Latching Devices

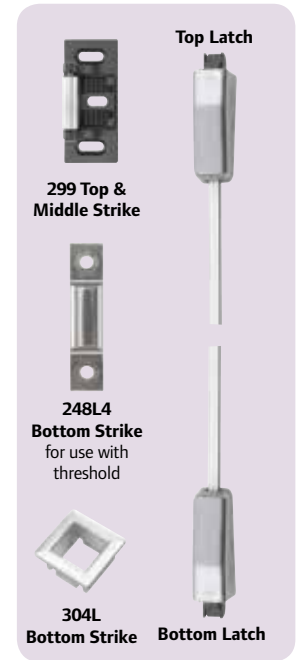

9857/9957 three-point latching device for all types of single or double doors, UL listed for Panic Exit Hardware. Devices are ANSI A156.3 – 2001 Grade 1. Covers stock hollow metal doors with 86 or 161 cutouts. The 9857 device has a smooth mechanism case and the 9957 device has a grooved case. The three-point latching device is non-handed except when the following device options are used: SD (Special Dogging), or SS (Signal Switch). See Opposite page for available outside trim and functions.

Vertical rod and latch guards are available to protect the bottom rod of the exit device from damage by impacts of carts or gurneys passing through doors.

Finishes – US3, US3A, US4, US4A, US10, US26, US26D, US26D-AM Antimicrobial, US28, 313, 315 & 643E. US15 and US32D available with 98 Series only.

Specifications

Device Functions	Device ships EO/DT/NL. Field selectable. For TP, K or L remove NL drive screw from device.
Device Lengths	3' 2'4" to 3' (711mm to 914 mm) Door Size 4' 2'10" to 4' (864 mm to 1219 mm) Door Size
Device Centerline from Finished Floor	39 ¹³ / ₁₆ " (1011 mm)
Center Case Dimensions	8" x 2 ³ / ₄ " x 2 ³ / ₈ " (203mm x 70mm x 60mm)
Mechanism Case Dimensions	2 ¹ / ₄ " x 2 ¹ / ₄ " (57mm x 57mm)
Projection	Pushbar Neutral – 3 ¹³ / ₁₆ " (97 mm) Pushbar Depressed – 3 ¹ / ₁₆ " (78 mm)
Latch Bolt	Deadlocking Anti-friction Top & Bottom Bolt, ⁵ / ₈ " (16mm) throw Deadlocking Rim Bolt, ³ / ₄ " (19mm) throw
Door Undercut	¹ / ₄ " (7mm) maximum recommended
Top & Bottom Latch Case	4 ¹ / ₂ " x 2 ¹ / ₈ " x 1 ¹ / ₂ " (114mm x 54mm x 38mm)
Vertical Rods	¹ / ₂ " square tubing, standard rods accommodate 7' (2134mm) doors. Top rod length: 34 ¹⁵ / ₁₆ " (887mm); Bottom rod length: 31 ¹ / ₂ " (794mm) Extension rods available in 1' (205mm) or 3' (914mm) for doors over 7'. One piece top rod is available for 8' (2438mm) and 10' (3048mm) doors.
Fasteners & Sex Bolts (SNB)	Includes screw pack for 1 ³ / ₄ " (44mm) to 2 ¹ / ₄ " (57mm) thick metal or wood doors, and 325 SNB for top and bottom latch. Optional 425 SNB available.

Electric Options	LX Latchbolt Monitor Switch RX Pushpad Monitor Switch RX2 Double Pushpad Monitor Switch E Electric Unlocking and Locking Trim EL Electric Latch Retraction QEL Quiet Electric Latch Retraction SS Signal Switch CX Chexit Delayed Exit ALK Alarm Exit Kit WP-RX Waterproof Request to Exit
Mechanical Options	GBK Glass Bead Kit PN Pneumatic Latch Retraction PL Pullman Latch SNB Sex Bolts SEC Security Screws
Dogging Feature	Hex key dogging standard
Dogging Options	CD Cylinder Dogging SD Special Center Case Dogging LD Less Dogging DI Dogging Indicator CI Cylinder Dogging Indicator
Strikes	Top & Middle - 299 – Dull Black Bottom - 248L4 & 304L - Unfinished

EL
Electric Latch Retraction

- Enables remote unlatching
- Alternative to manual dogging

QEL
Quiet Electric Latch Retraction

- Bolt retraction via switch
- Converts exit door to push-pull operation

PN
Pneumatic Latch Retraction

- For areas where electrical devices banned
- Special linkage for mechanical or pneumatic dogging

RG
Rod Guard

- Protection from carts/gurneys
- Eases wheelchair access

E (E 996L)
Electrified Breakaway Lever

- Electrified remote locking/unlocking
- Standard in fail safe condition

LX
Latchbolt Monitor Switch

- Signals use of an opening
- SPDT switch to monitor latch bolt

RX
Pushpad Monitor Switch

- Signals use of an opening
- SPDT switch to monitor pushpad





SS
Signal Switch





- Signals unauthorized use of an opening
- Switch makes latch bolt tamper-resistant

ALK
Alarm Exit Kit

- Unauthorized opening triggers 85-decibel horn
- Set in armed or disarmed mode by key

Standard Trim

	EO	DT	NL	NL-OP	TL	TL-BE
	Exit only	 Dummy Trim Pull When Dogged	 Night Latch Key Retracts Latchbolt	 Night Latch Key Retracts Latchbolt Optional Pull Required	 Thumbturn Key Locks & Unlocks (Use with DT Trim)	 Thumbturn Blank Escutcheon Always Operable (No Cylinder) (Use with DT Trim)
Product Description	9857EO 9957EO	9857DT 9957DT	9857NL 9957NL	9857NL-OP 9957NL-OP	9857TL 9957TL	9857TL-BE 9957TL-BE
Trim Description	—	990DT	990NL-R/V	110NL-MD 110NL-WD	374T x 990DT	374T-BE x 990DT
Escutcheon Plate Size	—	3" x 14 ³ / ₁₆ " x ³ / ₃₂ " (76x360x2mm)	3" x 14 ³ / ₁₆ " x ³ / ₃₂ " (76x360x2mm)	—	(70x273x21mm)	(70x273x21mm)
Pull Center to Center	—	5 ¹ / ₂ " (140mm)	5 ¹ / ₂ " (140mm)	—	—	—
Projection	—	2" (51mm)	2" (51mm)	—	2" (51mm)	2" (51mm)
ANSI Function	01	02	03	03	11 or 12	16
Cylinder Type	—	—	Rim	Rim	1 ¹ / ₄ " Mortise	—
Handing	—	—	—	—	—	—
Optional Trim	x990EO x996EO	x996K-DT x996L-DT x696DT x697DT	x996K-NL x996L-NL x696NL x697NL			
Optional #425 SNB Quantity for Device	6	2	2	6	2	2

	L	L-NL	L-BE	L-DT
	 Lever Key Locks & Unlocks	 Lever - Night Latch Key Retracts Latchbolt	 Lever - Blank Escutcheon Always operable (No Cylinder)	 Lever Dummy Trim Pull When Dogged
Product Description	9857L 9957L	9857L-NL 9957L-NL	9857L-BE 9957L-BE	9857L-DT 9957L-DT
Trim Description	996L-R/V*	996L-NL-R/V	996L-BE-R/V*	996L-DT
Escutcheon Plate Size	2 ³ / ₄ " X 10 ³ / ₄ " X ²⁷ / ₃₂ " (70x273x21mm)	2 ³ / ₄ " X 10 ³ / ₄ " X ²⁷ / ₃₂ " (70x273x21mm)	2 ³ / ₄ " X 10 ³ / ₄ " X ²⁷ / ₃₂ " (70x273x21mm)	2 ³ / ₄ " X 10 ³ / ₄ " X ²⁷ / ₃₂ " (70x273x21mm)
Pull Center to Center	—	—	—	—
Projection	2 ⁷ / ₈ " (73mm)	2 ⁷ / ₈ " (73mm)	2 ⁷ / ₈ " (73mm)	2 ⁷ / ₈ " (73mm)
ANSI Function	08	03	14	02
Cylinder Type	Rim	Rim	—	—
Handing	Handed/Reversible	Handed/Reversible	Handed/Reversible	Handed/Reversible
Optional #425 SNB Quantity for Device	2	2	2	2

* Electrified lever operation available

Notes

9857-F/9957-F Three-Point Latching Fire Exit Device **VON DUPRIN**



9857-F/9957-F fire exit three-point latching device for all types of single doors up to 4' x 8' (1219mm x 2438mm) or up to 8' x 8' (2438mm x 2438mm) double doors with 9954 or 9854 mullion, UL listed for Fire Exit Hardware. See page 68 for detailed information on UL listed fire exit hardware label and door opening size information. Devices are ANSI A156.3 – 2001 Grade 1. The 9857-F device has a smooth mechanism case and the 9957-F device has a grooved case. The three-point latch device is non-handed except when the following device option is used: SS (Signal Switch). See Opposite page for available outside trim and device functions.

Vertical rod and latch guards are available to protect the bottom rod of the exit device from damage by impacts of carts or gurneys passing through doors.

Finishes – US3, US3A, US4, US4A, US10, US26, US26D, US26D-AM Antimicrobial, US28, 313, 315 & 643E. US15 and US32D available with 98 Series only.

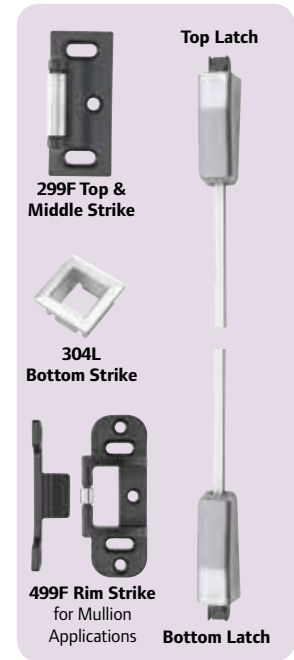

Specifications

Device Functions	Device ships EO/DT/NL. Field selectable. For TP, K or L remove NL drive screw from device.
Device Lengths	3' 2'4" to 3' (711mm to 914 mm) Door Size 4' 2'10" to 4' (864 mm to 1219 mm) Door Size
Device Centerline from Finished Floor	39 ¹³ / ₁₆ " (1011 mm)
Center Case Dimensions	8" x 2 ³ / ₄ " x 2 ³ / ₈ " (203mm x 70mm x 60mm)
Mechanism Case Dimensions	2 ¹ / ₄ " x 2 ¹ / ₄ " (57mm x 57mm)
Projection	Pushbar Neutral – 3 ¹³ / ₁₆ " (97 mm) Pushbar Depressed – 3 ¹ / ₁₆ " (78 mm)
Latch Bolt	Deadlocking Anti-friction Top & Bottom Bolt, ⁵ / ₈ " (16mm) throw Deadlocking Rim Bolt, ³ / ₄ " (19mm) throw.
Door Undercut	¹ / ₄ " (7mm) maximum
Top & Bottom Latch Case	4 ¹ / ₂ " x 2 ¹ / ₈ " x 1 ¹ / ₂ " (114mm x 54mm x 38mm)
Vertical Rods	¹ / ₂ " square tubing, standard rods accommodate 7' (2134mm) doors. Top rod length: 34 ¹³ / ₁₆ " (887mm); Bottom rod length: 31 ¹ / ₂ " (794mm) Extension rods available in 1' (205mm) or 3' (914mm) for doors over 7'. One piece top rod is available for 8' (2438mm) and 10' (3048mm) doors.
Fasteners & Sex Bolts (SNB)	Includes screw pack for 1 ³ / ₄ " (44mm) and 2 ¹ / ₄ " (57mm) thick metal or wood doors, and 325 SNB for top and bottom latch. Optional 425 SNB available for metal doors. 425 SNB <i>required</i> on wood doors without SLM blocking.

Electric Options	LX Latchbolt Monitor Switch RX Pushpad Monitor Switch RX2 Double Pushpad Monitor Switch E Electric Unlocking and Locking Trim EL Electric Latch Retraction QEL Quiet Electric Latch Retraction SS Signal Switch CX Chexit Delayed Exit ALK Alarm Exit Kit WP-RX Waterproof Request to Exit
Mechanical Options	GBK Glass Bead Kit PN Pneumatic Latch Retraction SNB Sex Bolts SEC Security Screws SLM Special Laminate Material Blocking
Dogging Option	No mechanical dogging. EL and QEL option available
Strikes	Top & Middle – 299 – Dull Black, Bottom – 304L – Unfinished

EL
Electric Latch Retraction

- Enables remote unlatching
- Alternative to manual dogging

QEL
Quiet Electric Latch Retraction

- Bolt retraction via switch
- Converts exit door to push-pull operation

PN
Pneumatic Latch Retraction

- For areas where electrical devices banned
- Special linkage for mechanical or pneumatic dogging

RG
Rod Guard

- Protection from carts/gurneys
- Eases wheelchair access

E (E 996L)
Electrified Breakaway Lever

- Electrified remote locking/unlocking
- Standard in fail safe condition

LX
Latchbolt Monitor Switch

- Signals use of an opening
- SPDT switch to monitor latch bolt

RX
Pushpad Monitor Switch

- Signals use of an opening
- SPDT switch to monitor pushpad

CX
Chexit Delayed Exit

- Meets NFPA 101 requirements
- Self-contained controls, locking, alarm

ALK
Alarm Exit Kit





- Unauthorized opening triggers 85-decibel horn
- Set in armed or disarmed mode by key





SG
Safety Glow

- Shows exit door location in darkness or smoke
- Developed to meet MEA standards

9857-F/9957-F Three-Point Latching Fire Exit Device

Standard Trim

	EO	DT	NL	NL-OP	TL	TL-BE
						
	Exit only	Dummy Trim Pull When Dogged (Not recommended for fire device)	Night Latch Key Retracts Latchbolt	Night Latch Key Retracts Latchbolt Optional Pull Required	Thumbturn Key Locks & Unlocks (Use with DT Trim)	Thumbturn Blank Escutcheon Always Operable (No Cylinder) (Use with DT Trim)
Product Description	9857EO-F 9957EO-F	— —	9857NL-F 9957NL-F	9857NL-OP-F 9957NL-OP-F	9857TL-F 9957TL-F	9857TL-BE-F 9957TL-BE-F
Trim Description	—	990DT	990NL-R/V	110NL-MD 110NL-WD	374T x 990DT	374T-BE x 990DT
Escutcheon Plate Size	—	3" x 14 ³ / ₁₆ " x ⁹ / ₃₂ " (76x360x2mm)	3" x 14 ³ / ₁₆ " x ⁹ / ₃₂ " (76x360x2mm)	—	(70x273x21mm)	(70x273x21mm)
Pull Center to Center	—	5 ¹ / ₂ " (140mm)	5 ¹ / ₂ " (140mm)	—	—	—
Projection	—	2" (51mm)	2" (51mm)	—	2" (51mm)	2" (51mm)
ANSI Function	01	02	03	03	11 or 12	16
Cylinder Type	—	—	Rim	Rim	1 ¹ / ₄ " Mortise	—
Handing	—	—	—	—	—	—
Optional Trim	x990EO x996EO	x996K-DT x996L-DT x696DT x697DT	x996K-NL x996L-NL x696NL x697NL			
#425 SNB optional - HMD req. WD w/o SLM pkg.	6	2	2	6	2	2
#425 SNB req. w/ 499F	2	2	2	2	2	2

	L	L-NL	L-BE	L-DT
				
	Lever Key Locks & Unlocks	Lever - Night Latch Key Retracts Latchbolt	Lever - Blank Escutcheon Always operable (No Cylinder)	Lever Dummy Trim Pull When Dogged
Product Description	9857L 9957L	9857L-NL 9957L-NL	9857L-BE 9957L-BE	— —
Trim Description	996L-R/V*	996L-NL-R/V	996L-BE-R/V*	996L-DT
Escutcheon Plate Size	2 ³ / ₄ " X 10 ³ / ₄ " X ²⁷ / ₃₂ " (70x273x21mm)	2 ³ / ₄ " X 10 ³ / ₄ " X ²⁷ / ₃₂ " (70x273x21mm)	2 ³ / ₄ " X 10 ³ / ₄ " X ²⁷ / ₃₂ " (70x273x21mm)	2 ³ / ₄ " X 10 ³ / ₄ " X ²⁷ / ₃₂ " (70x273x21mm)
Pull Center to Center	—	—	—	—
Projection	2 ⁷ / ₈ " (73mm)	2 ⁷ / ₈ " (73mm)	2 ⁷ / ₈ " (73mm)	2 ⁷ / ₈ " (73mm)
ANSI Function	08	03	14	02
Cylinder Type	Rim	Rim	—	—
Handing	Handed/Reversible	Handed/Reversible	Handed/Reversible	Handed/Reversible
#425 SNB optional - HMD req. WD w/o SLM pkg.	2	2	2	2
#425 SNB req. w/ 499F	2	2	2	2

* Electrified lever operation available

Notes

9847/9947 Concealed Vertical Rod Device

VON DUPRIN.



Hex key dogging comes standard on 9847/9947 Concealed Vertical Rod Devices



9847/9947 concealed vertical rod device for use on single or double metal doors, UL listed for Panic Exit Hardware. Devices are ANSI A156.3 – 2001 Grade 1. The 9847 device has a smooth mechanism case and the 9947 device has a grooved case. The concealed vertical rod device is non-handed except when the following device options are used: SD (Special Dogging), or SS (Signal Switch). See Opposite page for available outside trim and device functions.

Finishes – US3, US3A, US4, US4A, US10, US26, US26D, US26D-AM Antimicrobial, US28, 313, 315 & 643E. US15 and US32D available with 98 Series only.

Specifications	
Device Functions	Device ships EO/DT/NL. Field selectable. For TP, K or L remove NL drive screw from device.
Device Lengths	2' 2' (610mm) Door Size (shipped less UL label) 3' 2'4" to 3' (711mm to 914 mm) Door Size 4' 2'10" to 4' (864 mm to 1219 mm) Door Size
Device Centerline from Finished Floor	39 5/8" (1006 mm) Standard Adjustable from 35 5/8" (905mm) to 49 5/8" (1260mm)
Center Case Dimensions	8" x 2 3/4" x 2 3/8" (203mm x 70mm x 60mm)
Mechanism Case Dimensions	2 1/4" x 2 1/4" (57mm x 57mm)
Projection	Pushbar Neutral – 3 13/16" (97 mm) Pushbar Depressed – 3 1/16" (78 mm)
Latch Bolt	Deadlocking Top & Bottom Bolt, 5/8" (16mm) throw
Door Undercut	1/4" (7mm) maximum
Top & Bottom Latch Case	4 1/2" x 2 1/8" x 1 1/2" (114mm x 54mm x 38mm)
Vertical Rods	Round 2-piece adjustable rods – Top rod adjustable from 6'8" (2027mm) to 8'4" (2533mm). Bottom rod adjustable 35 5/8" (905 mm) to 49 5/8" (1260 mm). Extension rod kits available for doors over 8'4" (2533mm).
Fasteners & Sex Bolts (SNB)	Includes screw pack for 1 3/4" (44mm) and 2 1/4" (57mm) thick metal doors. Optional 425 SNB available.
Electric Options	LX Latchbolt Monitor Switch RX Pushpad Monitor Switch RX2 Double Pushpad Monitor Switch E Electric Unlocking and Locking Trim EL Electric Latch Retraction QEL Quiet Electric Latch Retraction SS Signal Switch CX Chexit Delayed Exit ALK Alarm Exit Kit WP-RX Waterproof Request to Exit
Mechanical Options	GBK Glass Bead Kit PN Pneumatic Latch Retraction LBR Less Bottom Rod PL Pullman Latch SNB Sex Bolts SEC Security Screws
Dogging Feature	Hex key dogging standard
Dogging Options	CD Cylinder Dogging SD Special Center Case Dogging LD Less Dogging DI Dogging Indicator CI Cylinder Dogging Indicator
Strikes	Top - 338 - Unfinished, Bottom - 385A - Unfinished

QEL
Quiet Electric Latch Retraction

- Bolt retraction via switch
- Converts exit door to push-pull operation

CD
Cylinder Dogging

- Replaces hex key dogging
- Requires standard 1 1/4" mortise cylinder

CX
Chexit Delayed Exit

- Meets NFPA 101 requirements
- Self-contained controls, locking, alarm

RX
Pushpad Monitor Switch

- Signals use of an opening
- SPDT switch to monitor pushpad

EL
Electric Latch Retraction

- Enables remote unlatching
- Alternative to manual dogging

ALK
Alarm Exit Kit

- Unauthorized opening triggers 85-decibel horn
- Set in armed or disarmed mode by key

PN
Pneumatic Latch Retraction

- For areas where electrical devices banned
- Special linkage for mechanical or pneumatic dogging

LX
Latchbolt Monitor Switch

- Signals use of an opening
- SPDT switch to monitor latch bolt

E (E 996L)
Electrified Breakaway Lever





- Electrified remote locking/unlocking
- Standard in fail safe condition





DI
Dogging Indicator

- Monitor dogging status without a control panel
- Red indicator light shows visibility to dogging from over 75 feet

9847/9947 Concealed Vertical Rod Device

Standard Trim

	EO	DT	NL	NL-OP	TL	TL-BE
						
	Exit only	Dummy Trim Pull When Dogged	Night Latch Key Retracts Latchbolt	Night Latch Key Retracts Latchbolt Optional Pull Required	Thumbturn Key Locks & Unlocks (Use with DT Trim)	Thumbturn Blank Escutcheon Always Operable (No Cylinder) (Use with DT Trim)
Product Description	9847EO 9947EO	9847DT 9947DT	9847NL 9947NL	9847NL-OP 9947NL-OP	9847TL 9947TL	9847TL-BE 9947TL-BE
Trim Description	—	990DT	990NL-R/V	110NL-MD	376T x 990DT	376T-BE x 990DT
Escutcheon Plate Size	—	3" x 14 ³ / ₁₆ " x ³ / ₃₂ " (76x360x2mm)	3" x 14 ³ / ₁₆ " x ³ / ₃₂ " (76x360x2mm)	—	(70x273x21mm)	(70x273x21mm)
Pull Center to Center	—	5 ¹ / ₂ " (140mm)	5 ¹ / ₂ " (140mm)	—	—	—
Projection	—	2" (51mm)	2" (51mm)	—	2" (51mm)	2" (51mm)
ANSI Function	01	02	03	03	11 or 12	16
Cylinder Type	—	—	Rim	Rim	1 ¹ / ₄ " Mortise	—
Handing	—	—	—	—	—	—
Optional Trim	x990EO x996EO	x996K-DT x996L-DT x697DT	x996K-NL x996L-NL x697NL			
Optional #425 SNB Quantity for Device	6	2	2	6	2	2

	L	L-NL	L-BE	L-DT
				
	Lever Key Locks & Unlocks	Lever - Night Latch Key Retracts Latchbolt	Lever - Blank Escutcheon Always operable (No Cylinder)	Lever Dummy Trim Pull When Dogged
Product Description	9847L 9947L	9847L-NL 9947L-NL	9847L-BE 9957L-BE	9847L-DT 9947L-DT
Trim Description	996L-R/V*	996L-NL-R/V	996L-BE-R/V*	996L-DT
Escutcheon Plate Size	2 ³ / ₄ " X 10 ³ / ₄ " X ²⁷ / ₃₂ " (70x273x21mm)	2 ³ / ₄ " X 10 ³ / ₄ " X ²⁷ / ₃₂ " (70x273x21mm)	2 ³ / ₄ " X 10 ³ / ₄ " X ²⁷ / ₃₂ " (70x273x21mm)	2 ³ / ₄ " X 10 ³ / ₄ " X ²⁷ / ₃₂ " (70x273x21mm)
Pull Center to Center	—	—	—	—
Projection	2 ⁷ / ₈ " (73mm)	2 ⁷ / ₈ " (73mm)	2 ⁷ / ₈ " (73mm)	2 ⁷ / ₈ " (73mm)
ANSI Function	08	03	14	02
Cylinder Type	Rim	Rim	—	—
Handing	Handed/Reversible	Handed/Reversible	Handed/Reversible	Handed/Reversible
Optional #425 SNB Quantity for Device	2	2	2	2

* Electrified lever operation available

Notes

9847-F/9947-F Concealed Vertical Rod Fire Exit Device

VON DUPRIN



9847-F/9947-F fire exit concealed vertical rod device for use on pairs of doors up to 8' x 10' (2438mm x 3048mm), UL listed for Fire Exit Hardware. See page 68 for detailed information on UL listed fire exit hardware label and door opening size information. Devices are ANSI A156.3 – 2001 Grade 1. The 9847-F device has a smooth mechanism case and the 9947-F device has a grooved case. The concealed vertical rod device is non-handed except when the following device option is used: SS (Signal Switch) devices. See Opposite page for available outside trim and functions.

Finishes – US3, US3A, US4, US4A, US10, US26, US26D, US26D-AM Antimicrobial, US28, 313, 315 & 643E. US15 and US32D available with 98 Series only.

Specifications

Device Functions	Device ships EO/DT/NL. Field selectable. For TP, K or L remove NL drive screw from device.
Device Lengths	2' 2' (610mm) Door Size (shipped less UL label) 3' 2'4" to 3' (711mm to 914 mm) Door Size 4' 2'10" to 4' (864 mm to 1219 mm) Door Size
Device Centerline from Finished Floor	39 5/8" (1006 mm) Standard Adjustable from 35 5/8" (905mm) to 49 5/8" (1260mm)
Center Case Dimensions	8" x 2 3/4" x 2 5/8" (203mm x 70mm x 60mm)
Mechanism Case Dimensions	2 1/4" x 2 1/4" (57mm x 57mm)
Projection	Pushbar Neutral – 3 1/16" (97 mm) Pushbar Depressed – 3 1/16" (78 mm)
Latch Bolt	Deadlocking Anti-friction Top & Bottom Bolt, 5/8" (16mm) throw
Door Undercut	1/4" (7mm) maximum
Top & Bottom Latch Case	3 3/4" x 1 1/2" x 1" (95mm x 38mm x 25mm)
Vertical Rods	Round 2-piece adjustable rods – Top rod adjustable from 6'8" (2027mm) to 8'4" (2533mm). Bottom rod adjustable 35 5/8" (905 mm) to 49 5/8" (1260 mm). Extension rod kits available for doors over 8'4" (2533mm).
Fasteners & Sex Bolts (SNB)	Includes screw pack for 1 3/4" (44mm) and 2 1/4" (57mm) thick metal doors. Optional 425 SNB available.
Electric Options	LX Latchbolt Monitor Switch RX Pushpad Monitor Switch RX2 Double Pushpad Monitor Switch E Electric Unlocking and Locking Trim EL Electric Latch Retraction QEL Quiet Electric Latch Retraction SS Signal Switch CX Chexit Delayed Exit ALK Alarm Exit Kit WP-RX Waterproof Request to Exit
Mechanical Options	LBR Less Bottom Rod PN Pneumatic Latch Retraction GBK Glass Bead Kit SNB Sex Bolts SEC Security Screws SLM Special Laminate Material Blocking
Dogging Feature	No mechanical dogging. EL and QEL option available.
Dogging Options	
Strikes	Top - 338 – Unfinished, Bottom – 385A - Unfinished

QEL
Quiet Electric Latch Retraction

- Bolt retraction via switch
- Converts exit door to push-pull operation

RX
Pushpad Monitor Switch

- Signals use of an opening
- SPDT switch to monitor pushpad

CX
Chexit Delayed Exit

- Meets NFPA 101 requirements
- Self-contained controls, locking, alarm

ALK
Alarm Exit Kit

- Unauthorized opening triggers 85-decibel horn
- Set in armed or disarmed mode by key

EL
Electric Latch Retraction

- Enables remote unlatching
- Alternative to manual dogging

SG
Safety Glow

- Shows exit door location in darkness or smoke
- Developed to meet MEA standards

PN
Pneumatic Latch Retraction

- For areas where electrical devices banned
- Special linkage for mechanical or pneumatic dogging

LX
Latchbolt Monitor Switch

- Signals use of an opening
- SPDT switch to monitor latch bolt





E (E 996L)
Electrified Breakaway Lever





- Electrified remote locking/unlocking
- Standard in fail safe condition

SS
Signal Switch

- Signals unauthorized use of an opening
- Switch makes latch bolt tamper-resistant

Standard Trim

	EO	DT	NL	NL-OP	TL	TL-BE
						
	Exit only	Dummy Trim Pull When Dogged (Not recommended for fire device)	Night Latch Key Retracts Latchbolt	Night Latch Key Retracts Latchbolt Optional Pull Required	Thumbturn Key Locks & Unlocks (Use with DT Trim)	Thumbturn Blank Escutcheon Always Operable (No Cylinder) (Use with DT Trim)
Product Description	9847EO-F 9947EO-F	—	9847NL-F 9947NL-F	9847NL-OP-F 9947NL-OP-F	9847TL-F 9947TL-F	9847TL-BE-F 9947TL-BE-F
Trim Description	—	990DT	990NL-R/V	110NL-MD	376T x 990DT	376T-BE x 990DT
Escutcheon Plate Size	—	3" x 14 ³ / ₁₆ " x ³ / ₃₂ " (76x360x2mm)	3" x 14 ³ / ₁₆ " x ³ / ₃₂ " (76x360x2mm)	—	(70x273x21mm)	(70x273x21mm)
Pull Center to Center	—	5 ¹ / ₂ " (140mm)	5 ¹ / ₂ " (140mm)	—	—	—
Projection	—	2" (51mm)	2" (51mm)	—	2" (51mm)	2" (51mm)
ANSI Function	01	02	03	03	11 or 12	16
Cylinder Type	—	—	Rim	Rim	1 ¹ / ₄ " Mortise	—
Handing	—	—	—	—	—	—
Optional Trim	x990EO x996EO	x996K-DT x996L-DT x696DT x697DT	x996K-NL x996L-NL x696NL x697NL			
#425 SNB optional - HMD req. WD w/o SLM pkg.	6	2	2	6	2	2

	L	L-NL	L-BE	L-DT
				
	Lever Key Locks & Unlocks	Lever - Night Latch Key Retracts Latchbolt	Lever - Blank Escutcheon Always operable (No Cylinder)	Lever Dummy Trim Pull When Dogged (Not recommended for fire device)
Product Description	9847L 9947L	9847L-NL 9947L-NL	9847L-BE 9957L-BE	—
Trim Description	996L-R/V*	996L-NL-R/V	996L-BE-R/V*	996L-DT
Escutcheon Plate Size	2 ³ / ₄ " X 10 ³ / ₄ " X ²⁷ / ₃₂ " (70x273x21mm)	2 ³ / ₄ " X 10 ³ / ₄ " X ²⁷ / ₃₂ " (70x273x21mm)	2 ³ / ₄ " X 10 ³ / ₄ " X ²⁷ / ₃₂ " (70x273x21mm)	2 ³ / ₄ " X 10 ³ / ₄ " X ²⁷ / ₃₂ " (70x273x21mm)
Pull Center to Center	—	—	—	—
Projection	2 ⁷ / ₈ " (73mm)	2 ⁷ / ₈ " (73mm)	2 ⁷ / ₈ " (73mm)	2 ⁷ / ₈ " (73mm)
ANSI Function	08	03	14	02
Cylinder Type	Rim	Rim	—	—
Handing	Handed/Reversible	Handed/Reversible	Handed/Reversible	Handed/Reversible
#425 SNB optional - HMD req. WD w/o SLM pkg.	2	2	2	2

* Electrified lever operation available

Notes

9848/9948 Concealed Vertical Rod Device

VON DUPRIN.



Hex key dogging comes standard on 9848/9948 Concealed Vertical Rod Devices



9848/9948 Concealed vertical rod device for use on single or double metal doors, UL listed for Panic Exit Hardware. Covers stock hollow metal doors with 86 or 161 cutouts. Devices are ANSI A156.3 – 2001 Grade 1. The 9848 device has a smooth mechanism case and the 9948 device has a grooved case.

The concealed vertical rod device is non-handed except when the following device options are used: SD (Special Dogging), or SS (Signal Switch). See Opposite page for available outside trim and functions.

Finishes – US3, US3A, US4, US4A, US10, US26, US26D, US26D-AM Antimicrobial, US28, 313, 315 & 643E. US15 and US32D available with 98 Series only.

Specifications	
Device Functions	Device ships EO/DT/NL. Field selectable. For TP, K or L remove NL drive screw from device.
Device Lengths	2' 2' (610mm) Door Size (shipped less UL label) 3' 2'4" to 3' (711mm to 914 mm) Door Size 4' 2'10" to 4' (864 mm to 1219 mm) Door Size
Device Centerline from Finished Floor	39 5/8" (1006 mm) Standard Adjustable from 35 5/8" (905mm) to 49 5/8" (1260mm)
Center Case Dimensions	8" x 2 3/4" x 2 5/8" (203mm x 70mm x 60mm)
Mechanism Case Dimensions	2 1/4" x 2 1/4" (57mm x 57mm)
Projection	Pushbar Neutral – 3 1/16" (97 mm) Pushbar Depressed – 3 1/16" (78 mm)
Latch Bolt	Deadlocking Top Bolt, 3/4" (19mm) throw Deadlocking Bottom Bolt, 1 1/2" (38mm) throw
Door Undercut	3/4" (19mm) maximum, more than 1/4" minimum
Top & Bottom Latch Case	4 1/4" x 1 1/2" x 1 1/8" (107mm x 38mm x 28mm)
Vertical Rods	Round 2-piece adjustable rods – Top rod adjustable from 6'8" (2027mm) to 8'4" (2533mm). Bottom rod adjustable 35 5/8" (905 mm) to 49 5/8" (1260 mm). Extension rod kits available for doors over 8'4" (2533mm).
Fasteners & Sex Bolts (SNB)	Includes screw pack for 1 3/4" (44mm) and 2 1/4" (57mm) thick metal doors. Optional 425 SNB available.
Electric Options	LX Latchbolt Monitor Switch RX Pushpad Monitor Switch RX2 Double Pushpad Monitor Switch E Electric Unlocking and Locking Trim EL Electric Latch Retraction QEL Quiet Electric Latch Retraction SS Signal Switch CX Chexit Delayed Exit ALK Alarm Exit Kit WP-RX Waterproof Request to Exit
Mechanical Options	GBK Glass Bead Kit PN Pneumatic Latch Retraction SNB Sex Bolts SEC Security Screws
Dogging Feature Dogging Options	Hex key dogging standard CD Cylinder Dogging SD Special Center Case Dogging LD Less Dogging DI Dogging Indicator CI Cylinder Dogging Indicator
Strikes	Top - 338 - Unfinished, Bottom - 385A - Unfinished

CX
Chexit Delayed Exit

- Meets NFPA 101 requirements
- Self-contained controls, locking, alarm

ALK
Alarm Exit Kit

- Unauthorized opening triggers 85-decibel horn
- Set in armed or disarmed mode by key

EL
Electric Latch Retraction

- Enables remote unlatching
- Alternative to manual dogging

SS
Signal Switch

- Signals unauthorized use of an opening
- Switch makes latch bolt tamper-resistant

PN
Pneumatic Latch Retraction

- For areas where electrical devices banned
- Special linkage for mechanical or pneumatic dogging

LX
Latchbolt Monitor Switch

- Signals use of an opening
- SPDT switch to monitor latch bolt

E (E 996L)
Electrified Breakaway Lever

- Electrified remote locking/unlocking
- Standard in fail safe condition

SG
Safety Glow

- Shows exit door location in darkness or smoke
- Developed to meet MEA standards

CD
Cylinder Dogging





- Replaces hex key dogging
- Requires standard 1 1/4" mortise cylinder





QEL
Quiet Electric Latch Retraction

- Bolt retraction via switch
- Converts exit door to push-pull operation

9848/9948 Concealed Vertical Rod Device

Standard Trim

	EO Exit only	DT  Dummy Trim Pull When Dogged	NL  Night Latch Key Retracts Latchbolt	NL-OP  Night Latch Key Retracts Latchbolt Optional Pull Required	TL  Thumbturn Key Locks & Unlocks (Use with DT Trim)	TL-BE  Thumbturn Blank Escutcheon Always Operable (No Cylinder) (Use with DT Trim)
Product Description	9848EO 9948EO	9848DT 9948DT	9848NL 9948NL	9848NL-OP 9948NL-OP	9848TL 9948TL	9848TL-BE 9948TL-BE
Trim Description	—	990DT	990NL-R/V	110NL-MD	376T x 990DT	376T-BE x 990DT
Escutcheon Plate Size	—	3" x 14 ³ / ₁₆ " x ³ / ₃₂ " (76x360x2mm)	3" x 14 ³ / ₁₆ " x ³ / ₃₂ " (76x360x2mm)	—	(70x273x21mm)	(70x273x21mm)
Pull Center to Center	—	5 ¹ / ₂ " (140mm)	5 ¹ / ₂ " (140mm)	—	—	—
Projection	—	2" (51mm)	2" (51mm)	—	3 ¹ / ₄ " (83mm)	3 ¹ / ₄ " (83mm)
ANSI Function	01	02	03	03	11	—
Cylinder Type	—	—	Rim	Rim	1 ¹ / ₄ " Mortise	—
Handing	—	—	—	—	—	—
Optional Trim	x990EO x996EO	x996K-DT x996L-DT x696DT x697D	x996K-NL x996L-NL x696NL x697NL			
Optional #425 SNB Quantity for Device	6	2	2	6	2	2

	L  Lever Key Locks & Unlocks	L-NL  Lever - Night Latch Key Retracts Latchbolt	L-BE  Lever - Blank Escutcheon Always operable (No Cylinder)	L-DT  Lever Dummy Trim Pull When Dogged
Product Description	9848L 9948L	9848L-NL 9948L-NL	9848L-BE 9958L-BE	9848L-DT 9948L-DT
Trim Description	996L-R/V*	996L-NL-R/V	996L-BE-R/V*	996L-DT
Escutcheon Plate Size	2 ³ / ₄ " X 10 ³ / ₄ " X ²⁷ / ₃₂ " (70x273x21mm)	2 ³ / ₄ " X 10 ³ / ₄ " X ²⁷ / ₃₂ " (70x273x21mm)	2 ³ / ₄ " X 10 ³ / ₄ " X ²⁷ / ₃₂ " (70x273x21mm)	2 ³ / ₄ " X 10 ³ / ₄ " X ²⁷ / ₃₂ " (70x273x21mm)
Pull Center to Center	—	—	—	—
Projection	2 ⁷ / ₈ " (73mm)	2 ⁷ / ₈ " (73mm)	2 ⁷ / ₈ " (73mm)	2 ⁷ / ₈ " (73mm)
ANSI Function	08	03	14	02
Cylinder Type	Rim	Rim	—	—
Handing	Handed/Reversible	Handed/Reversible	Handed/Reversible	Handed/Reversible
Optional #425 SNB Quantity for Device	2	2	2	2

* Electrified lever operation available

Notes



9848-F/9948-F concealed vertical rod device for use on pairs of doors up to 8' x 10' (2438mm x 3048mm), UL listed for Fire Exit Hardware. See page 68 for detailed information on UL listed fire exit hardware label and door opening size information. Devices are ANSI A156.3 – 2001 Grade 1. The 9848-F device has a smooth mechanism case and the 9948-F device has a grooved case. The concealed vertical rod device is non-handed except when the following device option is used: SS (Signal Switch). See Opposite page for available outside trim and functions.

Finishes – US3, US3A, US4, US4A, US10, US26, US26D, US26D-AM Antimicrobial, US28, 313, 315 & 643E. US15 and US32D available with 98 Series only.

Specifications

Device Functions	Device ships EO/DT/NL. Field selectable. For TP, K or L remove NL drive screw from device.
Device Lengths	2' 2' (610mm) Door Size (shipped less UL label) 3' 2'4" to 3' (711mm to 914 mm) Door Size 4' 2'10" to 4' (864 mm to 1219 mm) Door Size
Device Centerline from Finished Floor	39 5/8" (1006 mm) Standard Adjustable from 35 5/8" (905mm) to 49 5/8" (1260mm)
Center Case Dimensions	8" x 2 3/4" x 2 3/8" (203mm x 70mm x 60mm)
Mechanism Case Dimensions	2 1/4" x 2 1/4" (57mm x 57mm)
Projection	Pushbar Neutral – 3 13/16" (97 mm) Pushbar Depressed – 3 1/16" (78 mm)
Latch Bolt	Deadlocking Top Bolt, 3/4" (19mm) throw Deadlocking Bottom Bolt, 1 1/2" (38mm) throw
Door Undercut	3/4" (19mm) maximum, more than 1/4" minimum
Top & Bottom Latch Case	4 1/4" x 1 1/2" x 1 1/8" (107mm x 38mm x 28mm)
Vertical Rods	Round 2-piece adjustable rods – Top rod adjustable from 6'8" (2027mm) to 8'4" (2533mm). Bottom rod adjustable 35 5/8" (905 mm) to 49 5/8" (1260 mm). Extension rod kits available for doors over 8'4" (2533mm).
Fasteners & Sex Bolts (SNB)	Includes screw pack for 1 3/4" (44mm) and 2 1/4" (57mm) thick metal doors. Optional 425 SNB available.
Electric Options	LX Latchbolt Monitor Switch RX Pushpad Monitor Switch RX2 Double Pushpad Monitor Switch E Electric Unlocking and Locking Trim EL Electric Latch Retraction QEL Quiet Electric Latch Retraction SS Signal Switch CX Chexit Delayed Exit ALK Alarm Exit Kit WP-RX Waterproof Request to Exit
Mechanical Options	GBK Glass Bead Kit PN Pneumatic Latch Retraction SNB Sex Bolts SEC Security Screws SLM Special Laminate Material Blocking
Dogging Feature	No mechanical dogging. EL and QEL option available
Dogging Options	
Strikes	Top - 338 – Unfinished, Bottom – 385A - Unfinished

CX
Chexit Delayed Exit

- Meets NFPA 101 requirements
- Self-contained controls, locking, alarm

ALK
Alarm Exit Kit

- Unauthorized opening triggers 85-decibel horn
- Set in armed or disarmed mode by key

EL
Electric Latch Retraction

- Enables remote unlatching
- Alternative to manual dogging

SG
Safety Glow

- Shows exit door location in darkness or smoke
- Developed to meet MEA standards

PN
Pneumatic Latch Retraction

- For areas where electrical devices banned
- Special linkage for mechanical or pneumatic dogging

LX
Latchbolt Monitor Switch

- Signals use of an opening
- SPDT switch to monitor latch bolt

E (E 996L)
Electrified Breakaway Lever

- Electrified remote locking/unlocking
- Standard in fail safe condition

SS
Signal Switch

- Signals unauthorized use of an opening
- Switch makes latch bolt tamper-resistant

RX
Pushpad Monitor Switch





- Signals use of an opening
- SPDT switch to monitor pushpad





QEL
Quiet Electric Latch Retraction

- Bolt retraction via switch
- Converts exit door to push-pull operation

9848-F/9948-F Concealed Vertical Rod Fire Exit Device

Standard Trim

	EO Exit only	DT  Dummy Trim Pull When Dogged (Not recommended for fire device)	NL  Night Latch Key Retracts Latchbolt	NL-OP  Night Latch Key Retracts Latchbolt Optional Pull Required	TL  Thumbturn Key Locks & Unlocks (Use with DT Trim)	TL-BE  Thumbturn Blank Escutcheon Always Operable (No Cylinder) (Use with DT Trim)
Product Description	9848EO-F 9948EO-F	— —	9848NL-F 9948NL-F	9848NL-OP-F 9948NL-OP-F	9848TL-F 9948TL-F	9848TL-BE-F 9948TL-BE-F
Trim Description	—	990DT	990NL-R/V	110NL-MD	376T x 990DT	376T-BE x 990DT
Escutcheon Plate Size	—	3" x 14 ³ / ₁₆ " x ³ / ₃₂ " (76x360x2mm)	3" x 14 ³ / ₁₆ " x ³ / ₃₂ " (76x360x2mm)	—	(70x273x21mm)	(70x273x21mm)
Pull Center to Center	—	5 ¹ / ₂ " (140mm)	5 ¹ / ₂ " (140mm)	—	—	—
Projection	—	2" (51mm)	2" (51mm)	—	3 ¹ / ₄ " (83mm)	3 ¹ / ₄ " (83mm)
ANSI Function	01	02	03	03	11	—
Cylinder Type	—	—	Rim	Rim	1 ¹ / ₄ " Mortise	—
Handing	—	—	—	—	—	—
Optional Trim	x990EO x996EO	x996K-DT x996L-DT x696DT x697DT	x996K-NL x996L-NL x696NL x697NL			
#425 SNB optional - HMD req. WD w/o SLM pkg.	6	2	2	6	2	2

	L  Lever Key Locks & Unlocks	L-NL  Lever - Night Latch Key Retracts Latchbolt	L-BE  Lever - Blank Escutcheon Always operable (No Cylinder)	L-DT  Lever Dummy Trim Pull When Dogged (Not recommended for fire device)
Product Description	9848L-F 9948L-F	9848L-NL-F 9948L-NL-F	9848L-BE-F 998L-BE-F	— —
Trim Description	996L-R/V*	996L-NL-R/V	996L-BE-R/V*	996L-DT
Escutcheon Plate Size	2 ³ / ₄ " X 10 ³ / ₄ " X ²⁷ / ₃₂ " (70x273x21mm)	2 ³ / ₄ " X 10 ³ / ₄ " X ²⁷ / ₃₂ " (70x273x21mm)	2 ³ / ₄ " X 10 ³ / ₄ " X ²⁷ / ₃₂ " (70x273x21mm)	2 ³ / ₄ " X 10 ³ / ₄ " X ²⁷ / ₃₂ " (70x273x21mm)
Pull Center to Center	—	—	—	—
Projection	2 ⁷ / ₈ " (73mm)	2 ⁷ / ₈ " (73mm)	2 ⁷ / ₈ " (73mm)	2 ⁷ / ₈ " (73mm)
ANSI Function	08	03	14	02
Cylinder Type	Rim	Rim	—	—
Handing	Handed/Reversible	Handed/Reversible	Handed/Reversible	Handed/Reversible
#425 SNB optional - HMD req. WD w/o SLM pkg.	2	2	2	2

* Electrified lever operation available

Notes



Hex key dogging comes standard on 9849/9949 Concealed Vertical Cable Devices



9849/9949 concealed vertical cable device for use on single or double metal doors, UL listed for Panic Exit Hardware. Devices are ANSI A156.3 – 2001 Grade 1. The 9849 device has a smooth mechanism case and the 9949 device has a grooved case. The concealed vertical cable device is non-handed except when the following device options are used: SD (Special Dogging), or SS (Signal Switch). See Opposite page for available outside trim and device functions.

Finishes – US3, US3A, US4, US4A, US10, US26, US26D, US26D-AM Antimicrobial, US28, 313, 315 & 643E. US15 and US32D available with 98 Series only.

Specifications	
Device Functions	Device ships EO/DT/NL. Field selectable. For TP, K or L remove NL drive screw from device.
Device Lengths	2' 2' (610mm) Door Size (shipped less UL label) 3' 2'4" to 3' (711mm to 914 mm) Door Size 4' 2'10" to 4' (864 mm to 1219 mm) Door Size
Device Centerline from Finished Floor	39 5/8" (1006 mm) Standard
Center Case Dimensions	8" x 2 3/4" x 2 3/8" (203mm x 70mm x 60mm)
Mechanism Case Dimensions	2 1/4" x 2 1/4" (57mm x 57mm)
Projection	Pushbar Neutral – 3 13/16" (97 mm) Pushbar Depressed – 3 1/16" (78 mm)
Latch Bolt	Deadlocking Top & Bottom Bolt, 1/2" (13mm) throw
Door Undercut	3/4" (19mm) maximum (24231516 Spacer Block Kit needed for 3/4" undercut)
Top & Bottom Latch Case	5 13/16" x 1 1/4" x 1 7/16" (147mm x 32mm x 37mm)
Vertical Cable	7/32" (6mm) Diameter Stainless Steel Cables
Fasteners & Sex Bolts (SNB)	Includes screw pack for 1 3/4" (44mm) and 2 1/4" (57mm) thick metal doors. Optional 425 SNB available.
Electric Options	ALK Alarm Exit Kit CX Chexit Delayed Exit E Electric Unlocking and Locking Trim EL Electric Latch Retraction HD-EL Electric Latch Retraction w/ Hex Dogging QEL Quiet Electric Latch Retraction *LX Latchbolt Monitor Switch RX2 Double Pushpad Monitor Switch RX996L Trim Monitor Switch RX Pushpad Monitor Switch RXLC Pushpad Monitor Switch - Low Current SS Signal Switch WP-RX Waterproof Request to Exit
Mechanical Options	GBK Glass Bead Kit LBL Less Bottom Latch PN Pneumatic Latch Retraction SEC Security Screws SG Safety Glow SNB Sex Bolts
Dogging Feature Dogging Options	Hex key dogging standard CD Cylinder Dogging LD Less Dogging SD Special Center Case Dogging DI Dogging Indicator CI Cylinder Dogging Indicator
Strikes	Top - 249 - Unfinished, Bottom - 349 - Unfinished

QEL
Quiet Electric Latch Retraction
• Bolt retraction via switch
• Converts exit door to push-pull operation

CD
Cylinder Dogging
• Replaces hex key dogging
• Requires standard 1 1/4" mortise cylinder

CX
Chexit Delayed Exit
• Meets NFPA 101 requirements
• Self-contained controls, locking, alarm

RX
Pushpad Monitor Switch
• Signals use of an opening
• SPDT switch to monitor pushpad

EL
Electric Latch Retraction
• Enables remote unlatching
• Alternative to manual dogging

ALK
Alarm Exit Kit
• Unauthorized opening triggers 85-decibel horn
• Set in armed or disarmed mode by key

PN
Pneumatic Latch Retraction
• For areas where electrical devices banned
• Special linkage for mechanical or pneumatic dogging



DI
Dogging Indicator
• Monitor dogging status without a control panel
• Red indicator light shows visibility to dogging from over 75 feet





E (E 996L)
Electrified Breakaway Lever
• Electrified remote locking/unlocking
• Standard in fail safe condition

SG
Safety Glow
• Self illuminating touchpad
• No batteries or electronics

*For 98/9949 devices, LX switch monitors trim input or electric dogging of EL/QEL devices. LX switch does not monitor latchbolt condition.

Standard Trim

	EO	DT	NL	NL-OP
				
	Exit only	Dummy Trim Pull When Dogged	Night Latch Key Retracts Latchbolt	Night Latch Key Retracts Latchbolt Optional Pull Required
Product Description	9849EO 9949EO	9849DT 9949DT	9849NL 9949NL	9849NL-OP 9949NL-OP
Trim Description	—	990DT	990NL-R/V	110NL-MD
Escutcheon Plate Size	—	3" x 14 ³ / ₁₆ " x ³ / ₃₂ " (76x360x2mm)	3" x 14 ³ / ₁₆ " x ³ / ₃₂ " (76x360x2mm)	—
Pull Center to Center	—	5 ¹ / ₂ " (140mm)	5 ¹ / ₂ " (140mm)	—
Projection	—	2" (51mm)	2" (51mm)	—
ANSI Function	01	02	03	03
Cylinder Type	—	—	Rim	Rim
Handing	—	—	—	—
Optional Trim	x990EO x996EO	x996K-DT x996L-DT x697DT	x996K-NL x996L-NL x697NL	
Optional #425 SNB Quantity for Device	6	2	2	6

	L	L-NL	L-BE	L-DT
				
	Lever Key Locks & Unlocks	Lever - Night Latch Key Retracts Latchbolt	Lever - Blank Escutcheon Always operable (No Cylinder)	Lever Dummy Trim Pull When Dogged
Product Description	9849L 9949L	9849L-NL 9949L-NL	9849L-BE 9959L-BE	9849L-DT 9949 L-DT
Trim Description	996L-R/V*	996L-NL-R/V	996L-BE-R/V*	996L-DT
Escutcheon Plate Size	2 ³ / ₄ " X 10 ³ / ₄ " X ²⁷ / ₃₂ " (70x273x21mm)	2 ³ / ₄ " X 10 ³ / ₄ " X ²⁷ / ₃₂ " (70x273x21mm)	2 ³ / ₄ " X 10 ³ / ₄ " X ²⁷ / ₃₂ " (70x273x21mm)	2 ³ / ₄ " X 10 ³ / ₄ " X ²⁷ / ₃₂ " (70x273x21mm)
Pull Center to Center	—	—	—	—
Projection	2 ⁷ / ₈ " (73mm)	2 ⁷ / ₈ " (73mm)	2 ⁷ / ₈ " (73mm)	2 ⁷ / ₈ " (73mm)
ANSI Function	08	03	14	02
Cylinder Type	Rim	Rim	—	—
Handing	Handed/Reversible	Handed/Reversible	Handed/Reversible	Handed/Reversible
Optional #425 SNB Quantity for Device	2	2	2	2

* Electrified lever operation available.

Standard Door Opening Height	
Feet	Inches
6'8"	80"
7'	84"
8'	96"
9'	108"
10'	120"

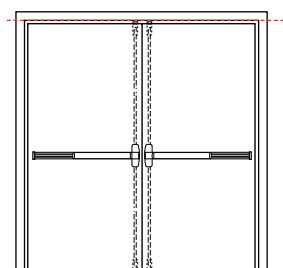

Door Opening Height

is measured from finished floor to frame rabbet on door side.

See table on left for standard offering.

Note: Non-standard sizes available with extended lead time. Consult Customer Care for more information 1-877-671-7011.

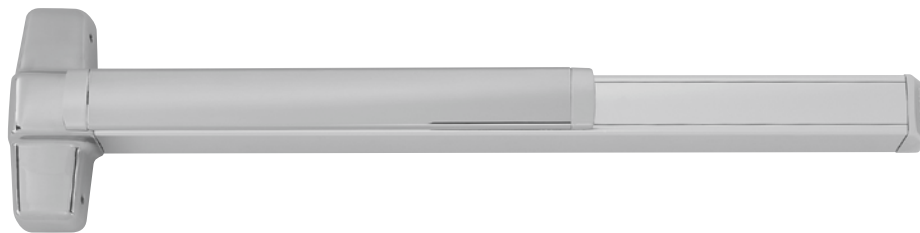

9849-F/9949-F fire exit concealed vertical cable device for use on pairs of doors up to 8' x 10' (2438mm x 3048mm), UL listed for Fire Exit Hardware. See page 68 for detailed information on UL listed fire exit hardware label and door opening size information. Devices are ANSI A156.3 – 2001 Grade 1. The 9849-F device has a smooth mechanism case and the 9949-F device has a grooved case. The concealed vertical cable device is non-handed except when the following device option is used: SS (Signal Switch) devices. See Opposite page for available outside trim and functions.

Finishes – US3, US3A, US4, US4A, US10, US26, US26D, US26D-AM Antimicrobial, US28, 313, 315 & 643E. US15 and US32D available with 98 Series only.

Specifications	
Device Functions	Device ships EO/DT/NL. Field selectable. For TP, K or L remove NL drive screw from device.
Device Lengths	2' 2' (610mm) Door Size (shipped less UL label) 3' 2'4" to 3' (711mm to 914 mm) Door Size 4' 2'10" to 4' (864 mm to 1219 mm) Door Size
Device Centerline from Finished Floor	39 5/8" (1006 mm) Standard
Center Case Dimensions	8" x 2 3/4" x 2 3/8" (203mm x 70mm x 60mm)
Mechanism Case Dimensions	2 1/4" x 2 1/4" (57mm x 57mm)
Projection	Pushbar Neutral – 3 13/16" (97 mm) Pushbar Depressed – 3 1/16" (78 mm)
Latch Bolt	Deadlocking Anti-friction Top & Bottom Bolt, 1/2" (13mm) throw
Door Undercut	3/4" (19mm) maximum (24231516 Spacer Block Kit needed for 3/4" undercut)
Top & Bottom Latch Case	5 13/16" x 1 1/4" x 1 7/16" (147mm x 32mm x 37mm)
Vertical Cable	7/32" (6mm) Diameter Stainless Steel Cables
Fasteners & Sex Bolts (SNB)	Includes screw pack for 1 3/4" (44mm) and 2 1/4" (57mm) thick metal doors. Optional 425 SNB available.
Electric Options	ALK Alarm Exit Kit CX Chexit Delayed Exit E Electric Unlocking and Locking Trim EL Electric Latch Retraction HD-EL Electric Latch Retraction w/ Hex Dogging *LX Latchbolt Monitor Switch QEL Quiet Electric Latch Retraction RX2 Double Pushpad Monitor Switch RX996L Trim Monitor Switch RX Pushpad Monitor Switch RXLC Pushpad Monitor Switch - Low Current SS Signal Switch WP-RX Waterproof Request to Exit
Mechanical Options	GBK Glass Bead Kit LBL Less Bottom Latch PN Pneumatic Latch Retraction SEC Security Screws SG Safety Glow SNB Sex Bolts
Dogging Feature	No mechanical dogging. EL and QEL option available.
Dogging Options	Strikes
Strikes	Top - 249 – Unfinished, Bottom - 349 - Unfinished

QEL
Quiet Electric Latch Retraction
 • Bolt retraction via switch
 • Converts exit door to push-pull operation

RX
Pushpad Monitor Switch
 • Signals use of an opening
 • SPDT switch to monitor pushpad

CX
Chexit Delayed Exit
 • Meets NFPA 101 requirements
 • Self-contained controls, locking, alarm

ALK
Alarm Exit Kit
 • Unauthorized opening triggers 85-decibel horn
 • Set in armed or disarmed mode by key

EL
Electric Latch Retraction
 • Enables remote unlatching
 • Alternative to manual dogging

SG
Safety Glow
 • Shows exit door location in darkness or smoke
 • Developed to meet MEA standards



PN
Pneumatic Latch Retraction
 • For areas where electrical devices banned
 • Special linkage for mechanical or pneumatic dogging





SS
Signal Switch
 • Signals unauthorized use of an opening
 • Switch makes latch bolt tamper-resistant

E (E 996L)
Electrified Breakaway Lever
 • Electrified remote locking/unlocking
 • Standard in fail safe condition

*For 98/9949 devices, LX switch monitors trim input or electric dogging of EL/QEL devices. LX switch does not monitor latchbolt condition.

Standard Trim

	EO	DT	NL	NL-OP
				
	Exit only	Dummy Trim Pull When Dogged (Not recommended for fire device)	Night Latch Key Retracts Latchbolt	Night Latch Key Retracts Latchbolt Optional Pull Required
Product Description	9849EO-F 9949EO-F	— —	9849NL-F 9949NL-F	9849NL-OP-F 9949NL-OP-F
Trim Description	—	990DT	990NL-R/V	110NL-MD
Escutcheon Plate Size	—	3" x 14 ³ / ₁₆ " x ³ / ₃₂ " (76x360x2mm)	3" x 14 ³ / ₁₆ " x ³ / ₃₂ " (76x360x2mm)	—
Pull Center to Center	—	5 ¹ / ₂ " (140mm)	5 ¹ / ₂ " (140mm)	—
Projection	—	2" (51mm)	2" (51mm)	—
ANSI Function	01	02	03	03
Cylinder Type	—	—	Rim	Rim
Handing	—	—	—	—
Optional Trim	x990EO x996EO	x996K-DT x996L-DT x696DT x697DT	x996K-NL x996L-NL x696NL x697NL	
#425 SNB optional - HMD req. WD w/o SLM pkg.	6	2	2	6

	L	L-NL	L-BE	L-DT
				
	Lever Key Locks & Unlocks	Lever - Night Latch Key Retracts Latchbolt	Lever - Blank Escutcheon Always operable (No Cylinder)	Lever Dummy Trim Pull When Dogged (Not recommended for fire device)
Product Description	9849L-F 9949L-F	9849L-NL-F 9949L-NL-F	9849L-BE-F 9959L-BE-F	— —
Trim Description	996L-R/V*	996L-NL-R/V	996L-BE-R/V*	996L-DT
Escutcheon Plate Size	2 ³ / ₄ " X 10 ³ / ₄ " X ²⁷ / ₃₂ " (70x273x21mm)	2 ³ / ₄ " X 10 ³ / ₄ " X ²⁷ / ₃₂ " (70x273x21mm)	2 ³ / ₄ " X 10 ³ / ₄ " X ²⁷ / ₃₂ " (70x273x21mm)	2 ³ / ₄ " X 10 ³ / ₄ " X ²⁷ / ₃₂ " (70x273x21mm)
Pull Center to Center	—	—	—	—
Projection	2 ⁷ / ₈ " (73mm)	2 ⁷ / ₈ " (73mm)	2 ⁷ / ₈ " (73mm)	2 ⁷ / ₈ " (73mm)
ANSI Function	08	03	14	02
Cylinder Type	Rim	Rim	—	—
Handing	Handed/Reversible	Handed/Reversible	Handed/Reversible	Handed/Reversible
#425 SNB optional - HMD req. WD w/o SLM pkg.	2	2	2	2

* Electrified lever operation available.

Standard Door Opening Height	
Feet	Inches
6'8"	80"
7'	84"
8'	96"
9'	108"
10'	120"

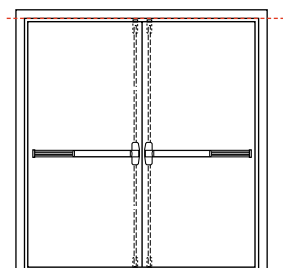

Door Opening Height

is measured from finished floor to frame rabbet on door side.

See table on left for standard offering.

Note: Non-standard sizes available with extended lead time. Consult Customer Care for more information 1-877-671-7011.

9847WDC/9947WDC

VON DUPRIN.

Wood Door Concealed Vertical Rod Device



Hex key dogging comes standard on 9847/9947 Wood Door Concealed Vertical Rod Devices

9847WDC/9947WDC concealed vertical rod device for use on single or double wood doors, UL listed for Panic Exit Hardware. Devices are ANSI A156.3 – 2001 Grade 1. The 9847WDC device has a smooth mechanism case and the 9947WDC device has a grooved case. The concealed vertical rod device is non-handed except when the following device options are used: SD (Special Dogging), or SS (Signal Switch). See Opposite page for available outside trim and functions.

Scalp Plate – Device is furnished standard with an 8" (203mm) long scalp plate for easy access to rods.

Note: Do not use on pair of doors with 9875/9975.

Finishes – US3, US4, US10, US26, US26D, US28 & 313. US15 and US32D available with 98 Series only.



Specifications

Device Functions	Device ships EO/DT/NL. Field selectable. For TP, K or L remove NL drive screw from device.
Device Lengths	2' 2' (610mm) Door Size (shipped less UL label) 3' 2'4" to 3' (711mm to 914 mm) Door Size 4' 2'10" to 4' (864 mm to 1219 mm) Door Size
Device Centerline from Finished Floor	39 13/16" (1006 mm) Standard Adjustable from 35 5/8" (905 mm) to 49 5/8" (1260mm)
Center Case Dimensions	8" x 2 3/4" x 2 3/8" (203mm x 70mm x 60mm)
Mechanism Case Dimensions	2 1/4" x 2 1/4" (57mm x 57mm)
Projection	Pushbar Neutral – 3 13/16" (97 mm) Pushbar Depressed – 3 1/16" (78 mm)
Latch Bolt	Deadlocking Top & Bottom Bolt, 5/8" (16mm) throw
Door Undercut	1/4" (7mm) maximum
Top & Bottom Latch Case	3 3/4" x 1 1/2" x 1" (95mm x 38mm x 25mm)
Vertical Rods	Round 2-piece adjustable rods – Top rod adjustable from 6'8" (2027mm) to 8'4" (2533mm). Bottom rod adjustable 35 5/8" (905 mm) to 49 5/8" (1260 mm). Extension rod kits available for doors over 8'4" (2533mm).
Fasteners & Sex Bolts (SNB)	Includes screw pack for 1 3/4" (44mm) and 2 1/4" (57mm) thick wood doors. 425 SNB <i>required</i> on wood doors without SLM blocking.
Electric Options	LX Latchbolt Monitor Switch RX Pushpad Monitor Switch RX2 Double Pushpad Monitor Switch E Electric Unlocking and Locking Trim EL Electric Latch Retraction QEL Quiet Electric Latch Retraction SS Signal Switch CX Chexit Delayed Exit ALK Alarm Exit Kit WP-RX Waterproof Request to Exit
Mechanical Options	GBK Glass Bead Kit PN Pneumatic Latch Retraction PL Pullman Latch LBR Less Bottom Rod SNB Sex Bolts SEC Security Screws
Dogging Feature Dogging Options	Hex key dogging standard CD Cylinder Dogging LD Less Dogging DI Dogging Indicator CI Cylinder Dogging Indicator
Strikes	Top – 338 – Unfinished, Bottom – 385A – Unfinished

QEL
Quiet Electric Latch Retraction
• Bolt retraction via switch
• Converts exit door to push-pull operation

CD
Cylinder Dogging
• Replaces hex key dogging
• Requires standard 1 1/4" mortise cylinder

CX
Chexit Delayed Exit
• Meets NFPA 101 requirements
• Self-contained controls, locking, alarm

RX
Pushpad Monitor Switch
• Signals use of an opening
• SPDT switch to monitor pushpad

EL
Electric Latch Retraction
• Enables remote unlatching
• Alternative to manual dogging

ALK
Alarm Exit Kit
• Unauthorized opening triggers 85-decibel horn
• Set in armed or disarmed mode by key

PN
Pneumatic Latch Retraction
• For areas where electrical devices banned
• Special linkage for mechanical or pneumatic dogging







LX
Latchbolt Monitor Switch
• Signals use of an opening
• SPDT switch to monitor latch bolt





E (E 996L)
Electrified Breakaway Lever
• Electrified remote locking/unlocking
• Standard in fail safe condition

PL
Pullman Latch
• Not for use with Fire Exit Hardware

9847/9947 Wood Door Concealed Vertical Rod Device

Standard Trim

	EO	DT	NL	NL-OP	TL	TL-BE
						
	Exit only	Dummy Trim Pull When Dogged	Night Latch Key Retracts Latchbolt	Night Latch Key Retracts Latchbolt Optional Pull Required	Thumbturn Key Locks & Unlocks (Use with DT Trim)	Thumbturn Blank Escutcheon Always Operable (No Cylinder) (Use with DT Trim)
Product Description	9847WDC-EO 9947WDC-EO	9847WDC-DT 9947WDC-DT	9847WDC-NL 9947WDC-NL	9847WDC-NL-OP 9947WDC-NL-OP	9847WDC-TL 9947WDC-TL	9847WDC-TL-BE 9947WDC-TL-BE
Trim Description	—	990DT	990NL-R/V	110NL-WD	376T-WDC x 990DT	376T-WDC-BE x 990DT
Escutcheon Plate Size	—	3" x 14 ³ / ₁₆ " x ⁹ / ₃₂ " (76x360x2mm)	3" x 14 ³ / ₁₆ " x ⁹ / ₃₂ " (76x360x2mm)	—	(70x273x21mm)	(70x273x21mm)
Pull Center to Center	—	5 ¹ / ₂ " (140mm)	5 ¹ / ₂ " (140mm)	—	—	—
Projection	—	2" (51mm)	2" (51mm)	—	2" (51mm)	2" (51mm)
ANSI Function	01	02	03	03	11 or 12	16
Cylinder Type	—	—	Rim	Rim	1 ¹ / ₄ " Mortise	—
Handing	—	—	—	—	—	—
Optional Trim	x990EO x996EO	x996K-DT x996L-DT x696DT x697DT	x996K-NL x996L-NL x696NL x697NL			
Optional #425 SNB Quantity for Device	6	2	2	6	2	2

	L	L-NL	L-BE	L-DT
				
	Lever Key Locks & Unlocks	Lever – Night Latch Key Retracts Latchbolt	Lever – Blank Escutcheon Always operable (No Cylinder)	Lever Dummy Trim Pull When Dogged
Product Description	9847WDC-L 9947WDC-L	9847WDC-L-NL 9947WDC-L-NL	9847WDC-L-BE 9947WDC-L-BE	9847WDC-L-DT 9947WDC-L-DT
Trim Description	996L-R/V*	996L-NL-R/V	996L-BE-R/V*	996L-DT
Escutcheon Plate Size	2 ³ / ₄ " X 10 ³ / ₄ " X ²⁷ / ₃₂ " (70x273x21mm)	2 ³ / ₄ " X 10 ³ / ₄ " X ²⁷ / ₃₂ " (70x273x21mm)	2 ³ / ₄ " X 10 ³ / ₄ " X ²⁷ / ₃₂ " (70x273x21mm)	2 ³ / ₄ " X 10 ³ / ₄ " X ²⁷ / ₃₂ " (70x273x21mm)
Pull Center to Center	—	—	—	—
Projection	2 ⁷ / ₈ " (73mm)	2 ⁷ / ₈ " (73mm)	2 ⁷ / ₈ " (73mm)	2 ⁷ / ₈ " (73mm)
ANSI Function	08	03	14	02
Cylinder Type	Rim	Rim	—	—
Handing	Handed/Reversible	Handed/Reversible	Handed/Reversible	Handed/Reversible
Optional #425 SNB Quantity for Device	2	2	2	2

* Electrified lever operation available

Notes

9847WDC-F/9947WDC-F

VON DUPRIN

Wood Door Concealed Vertical Rod Fire Device



9847WDC-F/9947WDC-F fire exit concealed vertical rod device for use on pairs of doors up to 8' x 9' 3" (2438mm x 2819mm) double wood doors, UL listed for Fire Exit Hardware. See page 68 for detailed information on UL listed fire exit hardware label and door opening size information.

Devices are ANSI A156.3 – 2001 Grade 1. The 9847WDC-F device has a smooth mechanism case and the 9947WDC-F device has a grooved case. The concealed vertical rod device is non-handed except when the following device options are used: SS (Signal Switch).

See Opposite page for available outside trim and functions.

Scalp Plate – Device is furnished standard with an 8" (203mm) long scalp plate for easy access to rods.

Note: Do not use on pair of doors with 9875-F/9975-F.

Finishes – US3, US4, US10, US26, US26D, US28 & 313. US15 and US32D available with 98 Series only.



Specifications

Device Functions	Device ships EO/DT/NL. Field selectable. For TP, K or L remove NL drive screw from device.
Device Lengths	2' 2' (610mm) Door Size (shipped less UL label) 3' 2'4" to 3' (711mm to 914 mm) Door Size 4' 2'10" to 4' (864 mm to 1219 mm) Door Size
Device Centerline from Finished Floor	39 13/16" (1006 mm) Standard Adjustable from 35 5/8" (905mm) to 49 5/8" (1260mm)
Center Case Dimensions	8" x 2 3/4" x 2 3/8" (203mm x 70mm x 60mm)
Mechanism Case Dimensions	2 1/4" x 2 1/4" (57mm x 57mm)
Projection	Pushbar Neutral – 3 13/16" (97 mm) Pushbar Depressed – 3 1/16" (78 mm)
Latch Bolt	Deadlocking Top & Bottom Bolt, 5/8" (16mm) throw
Door Undercut	1/4" (7mm) maximum
Top & Bottom Latch Case	3 3/4" x 1 1/2" x 1" (95mm x 38mm x 25mm)
Vertical Rods	Round 2-piece adjustable rods – Top rod adjustable from 6'8" (2027mm) to 8'4" (2533mm). Bottom rod adjustable 35 5/8" (905 mm) to 49 5/8" (1260 mm). Extension rod kits available for doors over 8'4" (2533mm).
Fasteners & Sex Bolts (SNB)	Includes screw pack for 1 3/4" (44mm) and 2 1/4" (57mm) thick wood doors. 425 SNB <i>required</i> on wood doors without SLM blocking.
Electric Options	LX Latchbolt Monitor Switch RX Pushpad Monitor Switch RX2 Double Pushpad Monitor Switch E Electric Unlocking and Locking Trim EL Electric Latch Retraction QEL Quiet Electric Latch Retraction SS Signal Switch CX Chexit Delayed Exit ALK Alarm Exit Kit WP-RX Waterproof Request to Exit
Mechanical Options	GBK Glass Bead Kit PN Pneumatic Latch Retraction LBR Less Bottom Rod SNB Sex Bolts SEC Security Screws SLM Special Laminate Material Blocking
Dogging Option	No Mechanical Dogging. EL and QEL option available
Strikes	Top – 338 – Unfinished, Bottom – 385A – Unfinished

QEL
Quiet Electric Latch Retraction

- Bolt retraction via switch
- Converts exit door to push-pull operation

RX
Pushpad Monitor Switch

- Signals use of an opening
- SPDT switch to monitor pushpad

CX
Chexit Delayed Exit

- Meets NFPA 101 requirements
- Self-contained controls, locking, alarm

ALK
Alarm Exit Kit

- Unauthorized opening triggers 85-decibel horn
- Set in armed or disarmed mode by key

EL
Electric Latch Retraction

- Enables remote unlatching
- Alternative to manual dogging

SG
Safety Glow

- Shows exit door location in darkness or smoke
- Developed to meet MEA standards

PN
Pneumatic Latch Retraction

- For areas where electrical devices banned
- Special linkage for mechanical or pneumatic dogging

LX
Latchbolt Monitor Switch





- Signals use of an opening
- SPDT switch to monitor latch bolt





E (E 996L)
Electrified Breakaway Lever

- Electrified remote locking/unlocking
- Standard in fail safe condition

9847WDC-F/9947WDC-F Wood Door Concealed Vertical Rod Fire Device

Standard Trim

	EO	DT  Dummy Trim Pull When Dogged (Not recommended for fire device)	NL  Night Latch Key Retracts Latchbolt	NL-OP  Night Latch Key Retracts Latchbolt Optional Pull Required	TL  Thumbturn Key Locks & Unlocks (Use with DT Trim)	TL-BE  Thumbturn Blank Escutcheon Always Operable (No Cylinder) (Use with DT Trim)
	Exit only					
Product Description	9847WDC-EO-F 9947WDC-EO-F	— —	9847WDC-NL-F 9947WDC-NL-F	9847WDC-NL-OP-F 9947WDC-NL-OP-F	9847WDC-TL-F 9947WDC-TL-F	9847WDC-TL-BE-F 9947WDC-TL-BE-F
Trim Description	—	990DT	990NL-R/V	110NL-WD	376TWDC x 990DT	376TWDC-BE x 990DT
Escutcheon Plate Size	—	3" x 14 ³ / ₁₆ " x ³ / ₃₂ " (76x360x2mm)	3" x 14 ³ / ₁₆ " x ³ / ₃₂ " (76x360x2mm)	—	(70x273x21mm)	(70x273x21mm)
Pull Center to Center	—	5 ¹ / ₂ " (140mm)	5 ¹ / ₂ " (140mm)	—	—	—
Projection	—	2" (51mm)	2" (51mm)	—	3 ¹ / ₄ " (83mm)	3 ¹ / ₄ " (83mm)
ANSI Function	01	02	03	03	11	—
Cylinder Type	—	—	Rim	Rim	1 ¹ / ₄ " Mortise	—
Handing	—	—	—	—	—	—
Optional Trim	x990EO x996EO	x996K-DT x996L-DT x996L-DT x696DT x697DT	x996K-NL x996L-NL x996L-NL x696NL x697NL			
#425 SNB optional - HMD req. WD w/o SLM pkg.	6	2	2	6	2	2

	L  Lever Key Locks & Unlocks	L-NL  Lever - Night Latch Key Retracts Latchbolt	L-BE  Lever - Blank Escutcheon Always operable (No Cylinder)	L-DT  Lever Dummy Trim Pull When Dogged (Not recommended for fire device)
Product Description	9847WDC-L-F 9947WDC-L-F	9847WDC-L-NL-F 9947WDC-L-NL-F	9847WDC-L-BE-F 9947WDC-L-BE-F	— —
Trim Description	996L-R/V	996L-NL-R/V	996L-BE-R/V*	996L-DT
Escutcheon Plate Size	2 ³ / ₄ " X 10 ³ / ₄ " X ²⁷ / ₃₂ " (70x273x21mm)	2 ³ / ₄ " X 10 ³ / ₄ " X ²⁷ / ₃₂ " (70x273x21mm)	2 ³ / ₄ " X 10 ³ / ₄ " X ²⁷ / ₃₂ " (70x273x21mm)	2 ³ / ₄ " X 10 ³ / ₄ " X ²⁷ / ₃₂ " (70x273x21mm)
Pull Center to Center	—	—	—	—
Projection	2 ⁷ / ₈ " (73mm)	2 ⁷ / ₈ " (73mm)	2 ⁷ / ₈ " (73mm)	2 ⁷ / ₈ " (73mm)
ANSI Function	08	03	14	02
Cylinder Type	Rim	Rim	—	—
Handing	Handed/Reversible	Handed/Reversible	Handed/Reversible	Handed/Reversible
#425 SNB optional - HMD req. WD w/o SLM pkg.	2	2	2	2

* Electrified lever operation available

Notes

9849WDC/9949WDC

VON DUPRIN.

Wood Door Concealed Vertical Cable Device



Hex key dogging comes standard on 9849/9949 Wood Door Concealed Vertical Cable Devices

9849WDC/9949WDC concealed vertical cable device for use on single or double wood doors, UL listed for Panic Exit Hardware. Devices are ANSI A156.3 – 2001 Grade 1. The 9847WDC device has a smooth mechanism case and the 9947WDC device has a grooved case. The concealed vertical cable device is non-handed except when the following device options are used: SD (Special Dogging), or SS (Signal Switch). See Opposite page for available outside trim and functions.

Scalp Plate – Device is furnished standard with an 8" (203mm) long scalp plate for easy access to cables. *Note: Do not use on pair of doors with 9975 devices.*

Finishes – US3, US3A, US4, US4A, US10, US26, US26D, US26D-AM Antimicrobial, US28, 313, 315 & 643E. US15 and US32D available with 98 Series only.



Specifications	
Device Functions	Device ships EO/DT/NL. Field selectable. For TP, K or L remove NL drive screw from device.
Device Lengths	2' 2' (610mm) Door Size (shipped less UL label) 3' 2'4" to 3' (711mm to 914 mm) Door Size 4' 2'10" to 4' (864 mm to 1219 mm) Door Size
Device Centerline from Finished Floor	39 5/8" (1006 mm) Standard
Center Case Dimensions	8" x 2 3/4" x 2 3/8" (203mm x 70mm x 60mm)
Mechanism Case Dimensions	2 1/4" x 2 1/4" (57mm x 57mm)
Projection	Pushbar Neutral – 3 13/16" (97 mm) Pushbar Depressed – 3 1/16" (78 mm)
Latch Bolt	Deadlocking Top & Bottom Bolt, 1 1/2" (38mm) throw
Door Undercut	3/4" (19mm) maximum (24231516 Spacer Block Kit needed for 3/4" undercut)
Top & Bottom Latch Case	5 13/16" x 1 1/4" x 1 7/16" (147mm x 32mm x 37mm)
Vertical Cables	7/32" (6mm) Diameter Stainless Steel Cables
Fasteners & Sex Bolts (SNB)	Includes screw pack for 1 3/4" (44mm) and 2 1/4" (57mm) thick wood doors. 425 SNB <i>required</i> on wood doors without SLM blocking.
Electric Options	ALK Alarm Exit Kit CX Chexit Delayed Exit E Electric Unlocking and Locking Trim EL Electric Latch Retraction HD-EL Electric Latch Retraction w/ Hex Dogging *LX Latchbolt Monitor Switch QEL Quiet Electric Latch Retraction RX2 Double Pushpad Monitor Switch RX996L Trim Monitor Switch RX Pushpad Monitor Switch RXLC Pushpad Monitor Switch - Low Current SS Signal Switch WP-RX Waterproof Request to Exit
Mechanical Options	GBK Glass Bead Kit LBL Less Bottom Latch PN Pneumatic Latch Retraction SEC Security Screws SG Safety Glow SNB Sex Bolts
Dogging Feature Dogging Options	Hex key dogging standard CD Cylinder Dogging SD Special Center Case Dogging LD Less Dogging DI Dogging Indicator CI Cylinder Dogging Indicator
Strikes	Top – 249 – Unfinished, Bottom – 349 – Unfinished

QEL
Quiet Electric Latch Retraction

- Bolt retraction via switch
- Converts exit door to push-pull operation

CD
Cylinder Dogging

- Replaces hex key dogging
- Requires standard 1 1/4" mortise cylinder

CX
Chexit Delayed Exit

- Meets NFPA 101 requirements
- Self-contained controls, locking, alarm

RX
Pushpad Monitor Switch

- Signals use of an opening
- SPDT switch to monitor pushpad

EL
Electric Latch Retraction

- Enables remote unlatching
- Alternative to manual dogging

ALK
Alarm Exit Kit

- Unauthorized opening triggers 85-decibel horn
- Set in armed or disarmed mode by key

PN
Pneumatic Latch Retraction

- For areas where electrical devices banned
- Special linkage for mechanical or pneumatic dogging

LX
Latchbolt Monitor Switch



- Signals use of an opening
- SPDT switch to monitor latch bolt





E (E 996L)
Electrified Breakaway Lever

- Electrified remote locking/unlocking
- Standard in fail safe condition

*For 98/9949 devices, LX switch monitors trim input or electric dogging of EL/QEL devices. LX switch does not monitor latchbolt condition.

Standard Trim

	EO	DT	NL	NL-OP
				
	Exit only	Dummy Trim Pull When Dogged	Night Latch Key Retracts Latchbolt	Night Latch Key Retracts Latchbolt Optional Pull Required
Product Description	9849WDC-EO 9949WDC-EO	9849WDC-DT 9949WDC-DT	9849WDC-NL 9949WDC-NL	9849WDC-NL-OP 9949WDC-NL-OP
Trim Description	—	990DT	990NL-R/V	110NL-WD
Escutcheon Plate Size	—	3" x 14 ³ / ₁₆ " x ³ / ₃₂ " (76x360x2mm)	3" x 14 ³ / ₁₆ " x ³ / ₃₂ " (76x360x2mm)	—
Pull Center to Center	—	5 ¹ / ₂ " (140mm)	5 ¹ / ₂ " (140mm)	—
Projection	—	2" (51mm)	2" (51mm)	—
ANSI Function	01	02	03	03
Cylinder Type	—	—	Rim	Rim
Handing	—	—	—	—
Optional Trim	x990EO x996EO	x996K-DT x996L-DT x696DT x697DT	x996K-NL x996L-NL x696NL x697NL	
Optional #425 SNB Quantity for Device	6	2	2	6

	L	L-NL	L-BE	L-DT
				
	Lever Key Locks & Unlocks	Lever - Night Latch Key Retracts Latchbolt	Lever - Blank Escutcheon Always operable (No Cylinder)	Lever Dummy Trim Pull When Dogged
Product Description	9849WDC-L 9949WDC-L	9849WDC-L-NL 9949WDC-L-NL	9849WDC-L-BE 9949WDC-L-BE	9849WDC-L-DT 9949WDC-L-DT
Trim Description	996L-R/V*	996L-NL-R/V	996L-BE-R/V*	996L-DT
Escutcheon Plate Size	2 ³ / ₄ " X 10 ³ / ₄ " X ²⁷ / ₃₂ " (70x273x21mm)	2 ³ / ₄ " X 10 ³ / ₄ " X ²⁷ / ₃₂ " (70x273x21mm)	2 ³ / ₄ " X 10 ³ / ₄ " X ²⁷ / ₃₂ " (70x273x21mm)	2 ³ / ₄ " X 10 ³ / ₄ " X ²⁷ / ₃₂ " (70x273x21mm)
Pull Center to Center	—	—	—	—
Projection	2 ⁷ / ₈ " (73mm)	2 ⁷ / ₈ " (73mm)	2 ⁷ / ₈ " (73mm)	2 ⁷ / ₈ " (73mm)
ANSI Function	08	03	14	02
Cylinder Type	Rim	Rim	—	—
Handing	Handed/Reversible	Handed/Reversible	Handed/Reversible	Handed/Reversible
Optional #425 SNB Quantity for Device	2	2	2	2

* Electrified lever operation available.

Standard Door Opening Height	
Feet	Inches
6'8"	80"
7'	84"
8'	96"
9'	108"
10'	120"

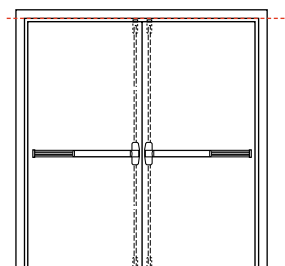

Door Opening Height

is measured from finished floor to frame rabbet on door side.

See table on left for standard offering.

Note: Non-standard sizes available with extended lead time. Consult Customer Care for more information 1-877-671-7011.

9849WDC-F/9949WDC-F

VON DUPRIN

Wood Door Concealed Vertical Cable Fire Device

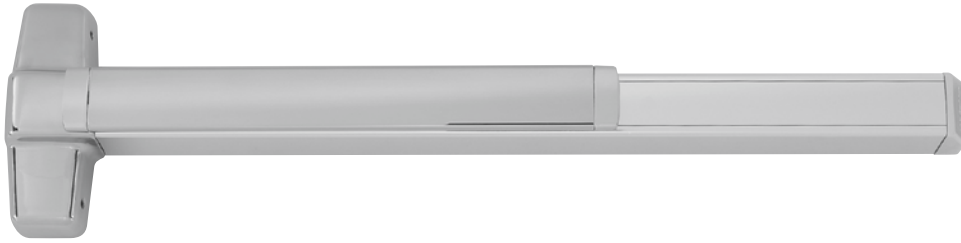

9849WDC-F/9949WDC-F fire exit concealed vertical cable device for use on pairs of doors up to 8' x 9' 3" (2438mm x 2819mm) double wood doors, UL listed for Fire Exit Hardware. See page 61 for detailed information on UL listed fire exit hardware label and door opening size information. Devices are ANSI A156.3 – 2001 Grade 1. The 9849WDC-F device has a smooth mechanism case and the 9949WDC-F device has a grooved case. The concealed vertical cable device is non-handed except when the following device options are used: SS (Signal Switch). See Opposite page for available outside trim and functions.

Scalp Plate – Device is furnished standard with an 8" (203mm) long scalp plate for easy access to cables. *Note: Do not use on pair of doors with 9975 devices.*

Finishes – US3, US3A, US4, US4A, US10, US26, US26D, US26D-AM Antimicrobial, US28, 313, 315 & 643E. US15 and US32D available with 98 Series only.



Specifications

Device Functions	Device ships EO/DT/NL. Field selectable. For TP, K or L remove NL drive screw from device.
Device Lengths	2' 2' (610mm) Door Size (shipped less UL label) 3' 2'4" to 3' (711mm to 914 mm) Door Size 4' 2'10" to 4' (864 mm to 1219 mm) Door Size
Device Centerline from Finished Floor	39 5/8" (1006 mm) Standard
Center Case Dimensions	8" x 2 3/4" x 2 3/8" (203mm x 70mm x 60mm)
Mechanism Case Dimensions	2 1/4" x 2 1/4" (57mm x 57mm)
Projection	Pushbar Neutral – 3 13/16" (97 mm) Pushbar Depressed – 3 1/16" (78 mm)
Latch Bolt	Deadlocking Top & Bottom Bolt, 1 1/2" (38mm) throw
Door Undercut	3/4" (19mm) maximum (24231516 Spacer Block Kit needed for 3/4" undercut)
Top & Bottom Latch Case	5 13/16" x 1 1/4" x 1 7/16" (147mm x 32mm x 37mm)
Vertical Rods	7/32" (6mm) Diameter Stainless Steel Cables
Fasteners & Sex Bolts (SNB)	Includes screw pack for 1 3/4" (44mm) and 2 1/4" (57mm) thick wood doors. 425 SNB <i>required</i> on wood doors without SLM blocking.
Electric Options	ALK Alarm Exit Kit CX Chexit Delayed Exit E Electric Unlocking and Locking Trim EL Electric Latch Retraction HD-EL Electric Latch Retraction w/ Hex Dogging *LX Latchbolt Monitor Switch QEL Quiet Electric Latch Retraction RX2 Double Pushpad Monitor Switch RX996L Trim Monitor Switch RX Pushpad Monitor Switch RXLC Pushpad Monitor Switch - Low Current SS Signal Switch WP-RX Waterproof Request to Exit
Mechanical Options	GBK Glass Bead Kit LBL Less Bottom Latch PN Pneumatic Latch Retraction SEC Security Screws SG Safety Glow SNB Sex Bolts SLM Special Laminate Material Blocking
Dogging Option	No Mechanical Dogging. EL and QEL option available
Strikes	Top – 249 – Unfinished, Bottom – 349 – Unfinished

QEL
Quiet Electric Latch Retraction
 • Bolt retraction via switch
 • Converts exit door to push-pull operation

RX
Pushpad Monitor Switch
 • Signals use of an opening
 • SPDT switch to monitor pushpad

CX
Chexit Delayed Exit
 • Meets NFPA 101 requirements
 • Self-contained controls, locking, alarm

ALK
Alarm Exit Kit
 • Unauthorized opening triggers 85-decibel horn
 • Set in armed or disarmed mode by key

EL
Electric Latch Retraction
 • Enables remote unlatching
 • Alternative to manual dogging

SG
Safety Glow
 • Shows exit door location in darkness or smoke
 • Developed to meet MEA standards



PN
Pneumatic Latch Retraction
 • For areas where electrical devices banned
 • Special linkage for mechanical or pneumatic dogging





LX
Latchbolt Monitor Switch
 • Signals use of an opening
 • SPDT switch to monitor latch bolt

E (E 996L)
Electrified Breakaway Lever
 • Electrified remote locking/unlocking
 • Standard in fail safe condition

*For 98/9949 devices, LX switch monitors trim input or electric dogging of EL/QEL devices. LX switch does not monitor latchbolt condition.

Standard Trim

	EO	DT	NL	NL-OP
				
	Exit only	Dummy Trim Pull When Dogged (Not recommended for fire device)	Night Latch Key Retracts Latchbolt	Night Latch Key Retracts Latchbolt Optional Pull Required
Product Description	9849WDC-EO-F 9949WDC-EO-F	— —	9849WDC-NL-F 9949WDC-NL-F	9849WDC-NL-OP-F 9949WDC-NL-OP-F
Trim Description	—	990DT	990NL-R/V	110NL-WD
Escutcheon Plate Size	—	3" x 14 ³ / ₁₆ " x ³ / ₃₂ " (76x360x2mm)	3" x 14 ³ / ₁₆ " x ³ / ₃₂ " (76x360x2mm)	—
Pull Center to Center	—	5 ¹ / ₂ " (140mm)	5 ¹ / ₂ " (140mm)	—
Projection	—	2" (51mm)	2" (51mm)	—
ANSI Function	01	02	03	03
Cylinder Type	—	—	Rim	Rim
Handing	—	—	—	—
Optional Trim	x990EO x996EO	x996K-DT x996L-DT) x996L-DT x696DT x697DT	x996K-NL x996L-NL x996L-NL x696NL x697NL	
Optional #425 SNB Quantity for Device	6	2	2	6

	L	L-NL	L-BE	L-DT
				
	Lever Key Locks & Unlocks	Lever - Night Latch Key Retracts Latchbolt	Lever - Blank Escutcheon Always operable (No Cylinder)	Lever Dummy Trim Pull When Dogged (Not recommended for fire device)
Product Description	9849WDC-L-F 9949WDC-L-F	9849WDC-L-NL-F 9949WDC-L-NL-F	9849WDC-L-BE-F 9949WDC-L-BE-F	— —
Trim Description	996L-R/V	996L-NL-R/V	996L-BE-R/V*	996L-DT
Escutcheon Plate Size	2 ³ / ₄ " X 10 ³ / ₄ " X ²⁷ / ₃₂ " (70x273x21mm)	2 ³ / ₄ " X 10 ³ / ₄ " X ²⁷ / ₃₂ " (70x273x21mm)	2 ³ / ₄ " X 10 ³ / ₄ " X ²⁷ / ₃₂ " (70x273x21mm)	2 ³ / ₄ " X 10 ³ / ₄ " X ²⁷ / ₃₂ " (70x273x21mm)
Pull Center to Center	—	—	—	—
Projection	2 ⁷ / ₈ " (73mm)	2 ⁷ / ₈ " (73mm)	2 ⁷ / ₈ " (73mm)	2 ⁷ / ₈ " (73mm)
ANSI Function	08	03	14	02
Cylinder Type	Rim	Rim	—	—
Handing	Handed/Reversible	Handed/Reversible	Handed/Reversible	Handed/Reversible
Optional #425 SNB Quantity for Device	2	2	2	2

* Electrified lever operation available.

Standard Door Opening Height	
Feet	Inches
6'8"	80"
7'	84"
8'	96"
9'	108"
10'	120"

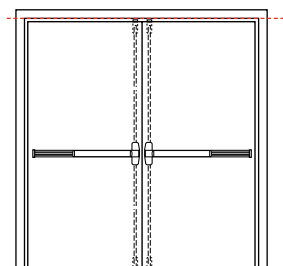









Door Opening Height

is measured from finished floor to frame rabbet on door side.

See table on left for standard offering.





Note: Non-standard sizes available with extended lead time. Consult Customer Care for more information 1-877-671-7011.

Knob, Exit Only and Thumbpiece Trim – 990 & 996K





 Knob Key Locks & Unlocks	 Knob – Night Latch Key Retracts Latchbolt	 Knob – Blank Escutcheon Always Operable (No Cylinder)	 Knob – Dummy Trim Pull When Dogged	 Exit Only Plate	 Thumbpiece Key Locks & Unlocks	 Thumbpiece Blank Escutcheon Always Operable (No Cylinder)	 Exit Only Plate
---	--	--	---	--	---	--	---

Trim Description	996K	996K-NL	996K-BE	996K-DT	996EO	990TP	990TP-BE	990EO
Escutcheon Plate Size	2¾" x 10¾" x 27/32" (70x273x21mm)	2¾" x 10¾" x 27/32" (70x273x21mm)	2¾" x 10¾" x 27/32" (70x273x21mm)	2¾" x 10¾" x 27/32" (70x273x21mm)	(76x360x2mm)	3" x 14¾" x 3/32" (76x360x2mm)	3" x 14¾" x 3/32" (76x360x2mm)	3" x 14¾" x 3/32" (76x360x2mm)
Pull Center to Center	—	—	—	—	—	5½" (140mm)	5½" (140mm)	5½" (140mm)
Projection	3¼" (83mm)	3¼" (83mm)	3¼" (83mm)	3¼" (83mm)	—	2" (51mm)	2" (51mm)	2" (51mm)
ANSI Function	08	09	14	02	01	05	14	14
Cylinder Type								
Rim or Vertical Rod Device	Rim	Rim	—	—	—	Rim	—	—
Mortise Lock Device	1¼" Mortise	1¼" Mortise			—	1¼" Mortise	—	—
Handing	—	—	—	—	—	—	—	—
#425 SNB optional-HMD Req. WD w/o SLM Pkg.	2	2	2	2	2	2	2	2
#825 SNB Req. WD w/o SLM Pkg F Rim device ONLY	2	2	2	2	2	2	2	2
#425 SNB Req. w/499F	2	2	2	2	2	2	2	2

Optional Trims – 696

	DT	NL	TP	TP-BE
				
	Dummy Trim Pull When Dogged (Not recommended for fire device)	Night Latch Key Retracts Latchbolt	Thumbpiece Key Locks & Unlocks	Thumbpiece – Blank Escutcheon Always Operable (No Cylinder)
Trim Description	696DT	696NL	696TP	696TP-BE
Escutcheon Plate Size	(70x273x21mm)	(70x273x21mm)	1 ⁵ / ₈ " x 13 ¹ / ₂ " x 3 ¹ / ₁₆ " (41x343x5mm)	1 ⁵ / ₈ " x 13 ¹ / ₂ " x 3 ¹ / ₁₆ " (41x343x5mm)
Pull Center to Center	5 ¹ / ₂ " (140mm)	5 ¹ / ₂ " (140mm)	5 ¹ / ₂ " (140mm)	5 ¹ / ₂ " (140mm)
Projection	2 ¹ / ₈ " (52mm)	2 ¹ / ₈ " (52mm)	2 ¹ / ₈ " (52mm)	2 ¹ / ₈ " (52mm)
ANSI Function	02	03	05	15
Cylinder Type				
Rim or Vertical Rod Device	—	Rim	Rim	—
Mortise Lock Device	—	1 ¹ / ₄ " Mortise	1 ¹ / ₄ " Mortise	—
Handing	—	—	—	—
#425 SNB optional-HMD Req. WD w/o SLM Pkg.	2	2	2	2
#825 SNB Req. WD w/o SLM Pkg F Rim device ONLY	2	2	2	2
#425 SNB Req. w/499F	2	2	2	2

Optional Trims – 697

	DT	NL	TP	TP-BE
				
	Dummy Trim Pull When Dogged (Not recommended for fire device)	Night Latch Key Retracts Latchbolt	Thumbpiece Key Locks & Unlocks	Thumbpiece – Blank Escutcheon Always Operable (No Cylinder)
			(3/4" Diameter Pull) (19mm)	(3/4" Diameter Pull) (19mm)
Trim Description	697DT	697NL	697TP	697TP-BE
Escutcheon Plate Size	(70x273x21mm)	(70x273x21mm)	1 ⁵ / ₈ " x 13 ¹ / ₂ " x 3 ¹ / ₁₆ " (41x343x5mm)	2 ³ / ₄ " x 10 ⁹ / ₁₆ " x 27 ¹ / ₃₂ " (70x273x21mm)
Pull Center to Center	5 ¹ / ₂ " (140mm)	5 ¹ / ₂ " (140mm)	5 ¹ / ₂ " (140mm)	5 ¹ / ₂ " (140mm)
Projection	3" (76mm)	3" (76mm)	3" (76mm)	3" (76mm)
ANSI Function	02	03	05	15
Cylinder Type				
Rim or Vertical Rod Device	—	Rim	Rim	—
Mortise Lock Device	—	1 ¹ / ₄ " Mortise	1 ¹ / ₄ " Mortise	—
Handing	—	—	—	—
#425 SNB optional-HMD Req. WD w/o SLM Pkg.	2	2	2	2
#825 SNB Req. WD w/o SLM Pkg F Rim device ONLY	2	2	2	2
#425 SNB Req. w/499F	2	2	2	2

E996L

Electrified Breakaway Lever

E996L electrified lever trim provides remote locking and unlocking. Furnished standard in fail safe (FS) condition, can be field converted to fail secure (FSE) where allowed. E996L is furnished standard with cylinder operation for nightlatch (NL) function, or with blank escutcheon (BE).



Specification:

Solenoid –
Continuous Duty 24VDC

Solenoid Draw –
0.22 amp.

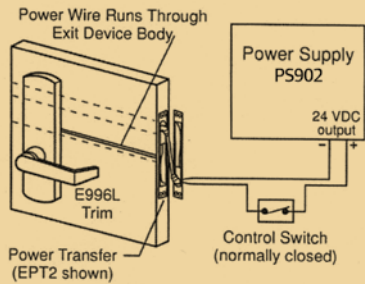

To order, specify:

1. Use "E" prefix, example E996L. When ordering with the exit device specify trim series with prefix "E", example 9927L-BE 3' US26D E996.
2. Device type, R/V (rim/surface vertical rod/concealed vertical rod) or M (mortise).
3. RHR furnished standard if not specified, field reversible.
4. Lever style (06 lever furnished standard).
Other levers, no extra charge.

HL6 Hospital Pull



Von Duprin and Glynn-Johnson have collaborated on an exit device trim that answers the problem of accessibility and performance. Using the Von Duprin 98/9975 mortise lock exit device along with the Glynn-Johnson HL6 Push/Pull latch, Ingersoll-Rand has created an exit device with mortise lock durability that utilizes a fully ADA compliant Pull paddle trim. The 98/9975HL device is available in all standard architectural finishes. Consult the

Glynn-Johnson catalog for complete product information.

392-7 Offset Pull



The 392-7 Offset Pull is 3/4" round stainless steel, with a 7" center to center which matches the 98/99 center case. Often used with a night latch operation. 3 1/2" (89mm) offset with 1 1/2" (38mm) clearance.

Vandal Resistant Trim: IVES VR910 & VR914 Series

VR910 grip coated in black plastisol for softer touch and resilience to temperature extremes. Grip designed for comfortable operation.

VR914 grip in all stainless steel.



Features:

- Stainless Steel construction, 11 gauge (0.120" thick)
- Finish: US32D, only
- Thru-bolts and rugged mounting screws for maximum fastening strength.
- Built-in lock protector prevents vandalism to mortise latchbolt (available on certain models).
- Extra-tough stainless steel cylinder collar prevents pipe wrench or similar tool from damaging cylinder. Tapered design prevents side impacts from transferring directly to cylinder. Collar spins freely.
- Furnished with mounting screws for door thicknesses of 1 3/4" to 2 1/4"

Model	For Use With	Size
VR910DT & VR914DT	98/99 Rim or Vertical Rod Device	5 1/4" (133mm) w x 11" (279mm) h
VR910NL & VR914NL	98/99 Rim or Vertical Rod Device	5 1/4" (133mm) w x 11" (279mm) h
VR910M-DT & VR914M-DT	9875/9975 Mortise Device	7 1/4" (184mm) w x 11" (279mm) h
VR910M-NL & VR914M-NL	9875/9975 Mortise Device	7 1/4" (184mm) w x 11" (279mm) h

- Meets ANSI/BHMA 156.13, Trim Security Test and California State Accessibility Standards Title 24.
- 1 1/2" (38mm) clearance from grip to door, total projection 1 7/8" (48mm)
- Consult the IVES catalog for complete product information.

This page intentionally left blank

AD-Series Adaptable Electronic Locks

The AD-Series was designed to be the right choice for today, and is ready to adapt to whatever the future holds.

There are a variety of options that allow you to select the AD-Series electronic lock that's right for you, and a wide selection of features that can be configured in the field to further customize each opening. When your needs change in the future, the innovative modular design of the AD-Series allows you to easily upgrade the credential reader or networking option, and adapt to emerging technologies using your existing chassis – all without taking the lock off the door. This means that you can be confident that your choice of the AD-Series is right for today, and that your investment will be protected into the future.



Credential Reader Options

AD-Series electronic locks are compatible with many different brands and technologies of credentials.



- Multi-Technology (reads 125 kHz prox and 13.56 MHz smart)
- + KEYPAD



- Magnetic Stripe (Insertion)
- + KEYPAD



- Magnetic Stripe (Swipe)
- + KEYPAD



- Keypad

Communications Options

Networked

In facilities where increased monitoring and control are needed, a networked solution is essential. The AD-Series networked options feature:

- Open Architecture Platform
- Acceptable reader technology
- Real-time Monitoring

The AD-Series networked lock is available in either a wireless or hardwired configuration to fit your application needs.

- AD-300** Networked Hardwired Locks
- AD-301** Networked Hardwired FIPS 201-1 Compliant Locks
- AD-400** Networked Wireless Locks
- AD-401** Networked Wireless FIPS 201-1 Compliant Locks

Standalone

Standalone locks are a cost-effective solution for doors that do not require real-time monitoring. The AD-Series standalone solution provides:

- Upgradability
- Audit Trail Reports
- Improved Credential Management

Schlage offers two AD-Series standalone solutions to fit your environment:

- AD-200** Access rights are stored on the lock
- AD-250** Access rights are stored on the magnetic stripe credential

Chassis

- Cylindrical
- Mortise
- Mortise Deadbolt
- Exit Trim*

Locking Functions

- Classroom/Storeroom
- Office
- Privacy
- Apartment

Lever Styles



Sparta Rhodes Athens Tubular

Warm Tone Finishes



605 Bright Brass 606 Satin Brass 612 Satin Bronze 643e Aged Bronze

Cool Tone Finishes



619 Satin Nickel 625 Bright Chrome 626 Satin Chrome 626AM Satin Chrome with Antimicrobial

Certifications

- ANSI/BMHA A156.25
- ANSI/BHMA Grade 1
- UL 294 Listed
- UL 10C
- ADA
- FCC part 15
- RoHS
- FIPS 201-1 (AD-301 and AD-401)

Complete Your System

Complete your AD-Series system with readers and credentials, biometric hand geometry readers, system components, HHD programming device and other wireless accessories.

*See AD-Series Exit Trim Compatibility Datasheet for complete list of compatibility by manufacturer.

Schlage CO-Series

CO-Series Electronic Locks from Schlage

In the world of standalone electronic locks, nothing compares to the CO-Series from Schlage. And because CO-Series locks offer a wide variety of options, it's easy to find the right solution for any facility. For openings with a relatively small number of users, we recommend the CO-100. It's an offline keypad programmable lock. For larger applications try the CO-200 or CO-250. They're computer programmable locks that can provide audit trails. They also offer dual credential options (card+PIN) that provide an even greater level of security.



Compatible

The CO-Series was designed to easily integrate into your facility. It can work in conjunction with Schlage and Locknetics electronic locks and offers expanded cylinder, exit device, and credential compatibility.

Exit Device Compatibility*

	Rim	SVR	CVR/CVC	Mortise
Von Duprin 98/99 & 98/99 XP	✓	✓	✓	✓
Von Duprin 22/22F	✓	✓		
Falcon 25	✓			

*See AD-Series Exit Trim Compatibility Datasheet for complete list of compatibility by manufacturer.

Cylinder Compatibility

	Full Size key-in-lever 6 pin	Full Size key-in-lever 7 pin	FSIC 6 & 7 pin	SFIC 6 & 7 pin
Schlage	●		●	●
Falcon	▲	*		
Sargent® (10L + 11L Full Size)	▲		▲	▲
Corbin Russwin®			▲	▲
Yale® (Includes Medeco 31 *0100 FSIC)			▲	▲
Best®				▲

- = with cylinder or less cylinder options
 - ▲ = less cylinder only
 - * = less cylinder, only with Sparta and Rhodes levers
- Note: See Price Book for specific configurations

Credential Compatibility

The CO-Series is compatible with many different brands and credential technologies.

For customers with an installed base of iButtons®, a combo proximity keyfob with iButton option is available to make an easy transition to proximity technology.

Class

CO-100

- Manually programmable
- Keypad only
- User rights stored on the lock

CO-200 (shown)

- Computer or manually programmable
- User rights stored on the lock

CO-250

- Computer programmable
- User rights stored on the card

Readers

- Keypad
- Proximity
- Proximity plus Keypad
- Magnetic Stripe (Swipe)
- Magnetic Stripe plus Keypad (Swipe)

Lever Styles



Chassis

- Cylindrical
- Mortise
- Mortise deadbolt
- Exit Trim

Power

- 4 standard off the shelf (AA) batteries

Functions

- Classroom/storeroom
- Office
- Privacy

Warm Tone Finishes

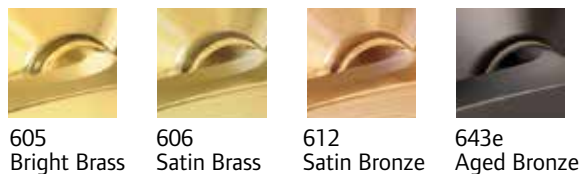

Cool Tone Finishes



Reliable

When it comes to securing your facility, you can't afford to take chances. CO-Series locks are tested to the highest quality and reliability standards in the industry, including:

- ANSI/BHMA A156.25 & ANSI/BHMA Grade 1
- UL 294
- ADA
- UL 10C

DEVICE TYPE	STANDARD SINGLE DOOR			STANDARD DOUBLE DOOR			OPTIONAL SINGLE DOOR			OPTIONAL DOUBLE DOOR		
	STRIKE	TRIM/STILE		STRIKE W/MULLION*	TRIM/STILE		STRIKE	TRIM/STILE		STRIKE W/MULLION*	TRIM/STILE	
98/99	299	990/996	696/697		990/996	696/697		990/996	696/697		990/996	696/697
		4 1/2" (114mm)	4 3/8" (111mm)	299 x 4954	4 7/8" (124mm)	4 3/4" (121mm)	1439 or 1410	3 13/16" (97mm)	3 13/16" (97mm)	299 x 5654	4 7/16" (113mm)	4 1/4" (108mm)
							1606	4 1/16" (103mm)	3 13/16" (100mm)	1408 x 5754	3 13/16" (97mm)	3 13/16" (97mm)
XP 98/99	909			909 x 4954-XP			—	—	—	—	—	—
98-F/99-F	299F	4 1/2" (114mm)	4 3/8" (111mm)	499F x 9954	4 7/8" (124mm)	4 3/4" (121mm)	—	—	—	499F x 9854 KR9954	—	—
XP98-F/XP99-F	909			954 x 9954-XP			—	—	—	—	—	—
9875 9975	575	4 3/4" (121mm)	4 3/4" (121mm)	575-2	—	—	—	—	—	576A-576B	4 3/4" (121mm)	4 3/4" (121mm)
9875-F 9975-F	575	4 3/4" (121mm)	4 3/4" (121mm)	575-2	—	—	—	—	—	576A-576B	4 3/4" (121mm)	4 3/4" (121mm)
9857 9957	299 (Top) 299 (Middle) 304L/284-L (Bottom)	4 1/2" (114mm)	4 3/8" (111mm)	299 x 4954	4 7/8" (124mm)	4 3/4" (121mm)	1439 or 1410	3 13/16" (97mm)	3 13/16" (97mm)	299 x 5654	4 7/16" (113mm)	4 1/4" (108mm)
										1408 x 5754	3 13/16" (97mm)	3 13/16" (97mm)
							1606	4 1/16" (103mm)	3 13/16" (100mm)	1606 x 1654	4 3/4" (112mm)	4 1/4" (108mm)
9857-F 9957-F	299 (Top) 299F (Middle) 304L (Bottom)	4 1/2" (114mm)	4 3/8" (111mm)	299F 499F x 9954 304L	4 7/8" (124mm)	4 3/4" (121mm)	—	—	—	—	—	—
	STRIKE	APPLICATION			TRIM/STILE		OPTIONAL STRIKE			APPLICATION	TRIM/STILE	
9827 9927 LATCH RETRACTION PL9827/PL9927 PULLMAN LATCH 9827-F 9927-F 9847 9947 9848 9948	299 (Top) 304L/248-L-4 (Bottom)	Single Door			990/996	696/697	260U (Top) 385A (Bottom)	Single Door			990/996	696/697
		299 (Top) 304L/248-L-4 (Bottom)	Two Vertical Rod Devices			3 11/16" (94mm)		3 3/8" (92mm)	260U (Stainless) 385A (Bottom)	Two Vertical Rod Devices		
	299 (Top) 304L (Bottom)		Vertical Rod with Mortise Lock Device			4 3/4" (121mm)	4 3/4" (121mm)	304L (Bottom)		Vertical Rod with Mortise Lock Device		
	338 (Top) 385A (Bottom)	Two Vertical Rods			4 1/4" (108mm)	4 1/8" (105mm)	304L (Bottom)	Two Vertical Rods			4 1/4" (108mm)	4 1/8" (105mm)
	Vertical Rod with Mortise Lock Device			4 3/4" (121mm)	4 3/4" (121mm)	Vertical Rod with Mortise Lock Device			4 3/4" (121mm)	4 3/4" (121mm)		
9847WDC 9947WDC	338 (Top) 385A (Bottom)	Single Door			4 1/4" (108mm)	4 1/4" (108mm)	304L	Single Door			4 1/4" (108mm)	4 1/4" (108mm)
		Two Vertical Rod Devices			4 1/4" (108mm)	4 1/4" (108mm)		Two Vertical Rod Devices			4 1/4" (108mm)	4 1/4" (108mm)
		Vertical Rod with Mortise Lock Device			4 3/4" (121mm)	4 3/4" (121mm)		Vertical Rod with Mortise Lock Device			4 3/4" (121mm)	4 3/4" (121mm)
9847WDC-F 9947WDC-F	338 (Top) 385A (Bottom)	Two Vertical Rod Devices			4 1/4" (108mm)	4 1/4" (108mm)	304L	Two Vertical Rod Devices			4 1/4" (108mm)	4 1/4" (108mm)
9849 9949	249 (Top) 349 (Bottom)	Vertical Cable with Mortise Lock Device			4 3/4" (121mm)	4 3/4" (121mm)	—	Vertical Cable with Mortise Lock Device			4 3/4" (121mm)	4 3/4" (121mm)
9849-F 9949-F 9849-F 9949-F	249 (Top) 349 (Bottom)	Two Vertical Cables			4 1/4" (108mm)	4 1/8" (105mm)	—	Two Vertical Cable			4 1/4" (108mm)	4 1/8" (105mm)
		Vertical Cable with Mortise Lock Device			4 3/4" (121mm)	4 3/4" (121mm)		Vertical Cable with Mortise Lock Device			4 3/4" (121mm)	4 3/4" (121mm)
		Single Door			4 1/4" (108mm)	4 1/4" (108mm)		Single Door			4 1/4" (108mm)	4 1/4" (108mm)
9849WDC 9949WDC	249 (Top) 349 (Bottom)	Two Vertical Cable Devices			4 1/4" (108mm)	4 1/4" (108mm)	—	Two Vertical Cable Devices			4 1/4" (108mm)	4 1/4" (108mm)
		Vertical Cable with Mortise Lock Device			4 1/4" (108mm)	4 1/4" (108mm)		Vertical Cable with Mortise Lock Device			4 3/4" (121mm)	4 3/4" (121mm)
		Single Door			4 1/4" (108mm)	4 1/4" (108mm)		Single Door			4 1/4" (108mm)	4 1/4" (108mm)
9849WDC-F 9949WDC-F	249 (Top) 349 (Bottom)	Two Vertical Cable Devices			4 1/4" (108mm)	4 1/4" (108mm)	—	Two Vertical Cable Devices			4 1/4" (108mm)	4 1/4" (108mm)

Strikes for rim devices

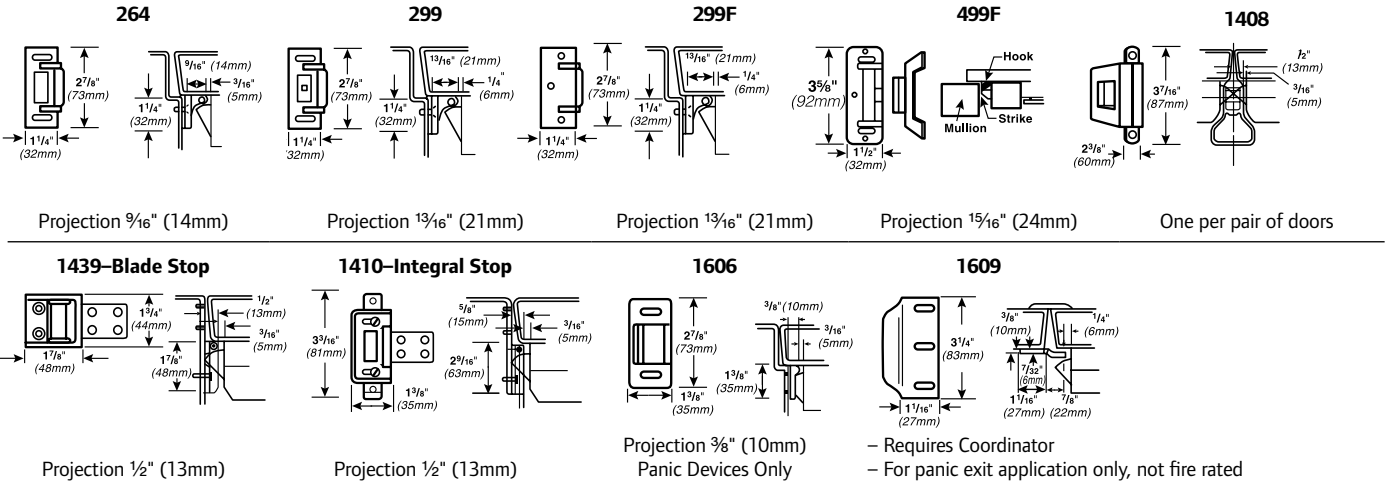

XP Strikes for rim devices

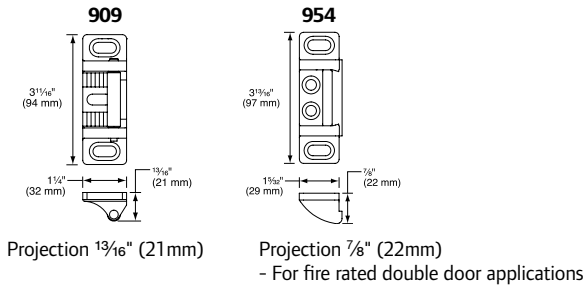

Strikes for vertical cable devices

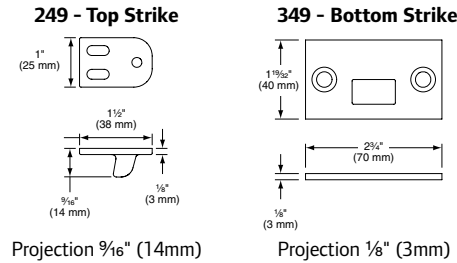

Strikes for vertical rod devices

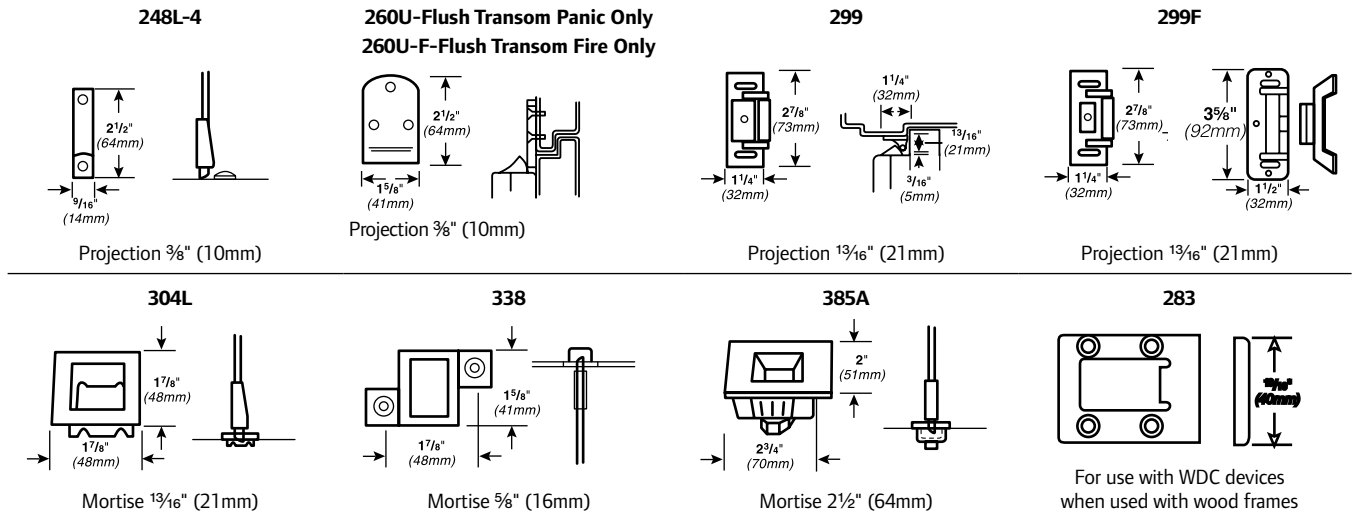

Strikes for mortise rod devices

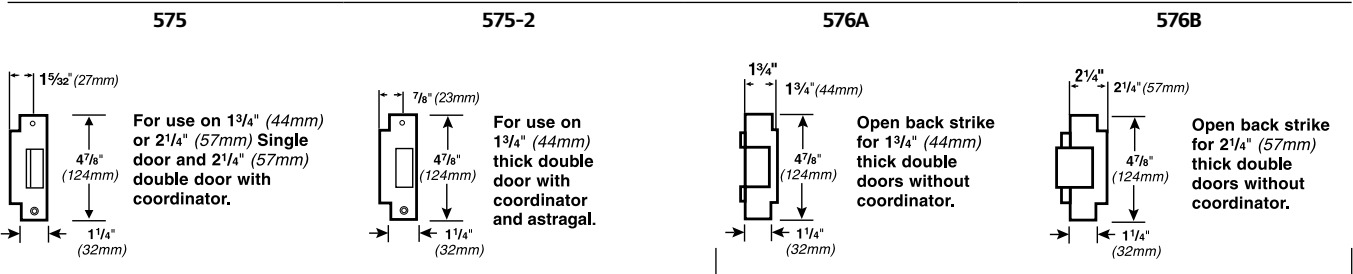

- Not for use with astragals
- For use on wood doors, contact door manufacturer

- Acceptable for 90 minute pair of hollow metal doors

CD Cylinder Dogging



Cylinder dogging is available on all 98/99™ Panic Exit devices to replace the standard hex key dogging. Unit requires a standard 1¼" (32mm) mortise cylinder with an inverted straight cam (Schlage Cam B502-191 reference).

To Order, Specify:

- Use prefix, CD, example CD99L

CDK Cylinder Dogging Kit*

For field conversion, a cylinder dogging conversion kit is available.

Order: 99CDK or 98CDK, specify finish.

*Cannot be added to fire exit hardware.

HDK Hex Key Dogging Kit*

For field conversion, a hex key dogging conversion kit is available.



Order: 99HDK or 98HDK, specify finish.

*Cannot be added to fire exit hardware.

LD Less Dogging

Less Dogging is available in all 98/99™ Panic Exit devices to remove the dogging option.

To Order, Specify:

- Use prefix LD, example LD99L

Dog Keys

Dog Key (old style)

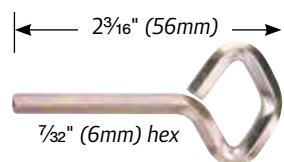

Dog Key (standard)

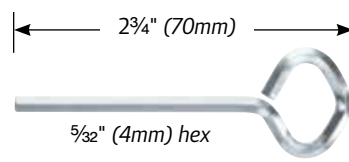

SD Special Center Case Dogging



Special cylinder dogging in the center case is available for Chexit, EL, QEL, ALK panic devices to allow for mechanical push/pull operation. With this option, the latchbolt is held retracted and pushbar is still operable. Specify handing—RHR or LHR.

SD requires 1¼" (32mm) mortise cylinder with an inverted straight cam. (Schlage cam reference B502-191.)

Note: Available on Rim and Vertical Rod Panic Exit Devices only.

To Order, Specify:

- Use prefix SD, example SD99L and Handing
- Not for 98/9975 Devices

Double Cylinder



Double cylinder features an inside key cylinder which locks or unlocks the outside trim and an outside key cylinder which retracts the latch bolt only (Night Latch Function). Available on rim or mortise lock device.

Rim requires two rim type cylinders. Mortise device requires 1 rim cylinder and 1 mortise cylinder 1¼" with a straight cam. (Schlage cam reference B502-191.)

Available functions are thumbpiece, knob or lever.

To Order, Specify:

1. Suffix-2 with device/trim number, example 99TP-2.
2. Handing required, LHR or RHR.

-2SI Double Cylinder with Security Indicator

The Von Duprin Classroom Security Indicator provides an at-a-glance verification of the locked/unlocked status of the door from inside of the room.

This option can be ordered as a new product or as a retrofit conversion kit to an existing 98/99 device. Indicator in Unlocked state presents a 1/2" x 1/2" metal flag (white background with black icon) at top of device head. Indicator in Locked state has no flag present.



To Order, Specify:

1. Suffix-2SI with device/trim number, example 99L-2SI.
2. Handing required, LHR or RHR.

RX Request to Exit

The RX feature is used to signal the use of an opening. This device is equipped with one internal SPDT switch which monitors the pushpad.

The device can be connected to a security console, or may be used as a single door alarm when used with a horn and power supply.

The RX switch option should not be used to control a load, but as a signalling switch (0.5 amps. resistive maximum).

The RX switch is available in a low current (LC) switch. Most commonly used in computer operated monitoring systems.

To Order, Specify:

- Standard – Use prefix RX, example RX99EO
- Low Current – Use prefix RX-LC, example RX-LC98EO

RX2 Double Request to Exit

The RX2 feature uses two RX switches.

To Order, Specify:

- Standard – Use prefix RX2, example RX299EO

WP-RX Waterproof Request to Exit

LX Latchbolt Monitoring



The LX feature is used to signal the use of an opening. This device is equipped with one internal SPDT switch which monitors the latch bolt.

The device can be connected to a security console, or may be used as a single door alarm when used with a horn and power supply.

The LX switch option should not be used to control a load, but as a signalling switch (0.5 amps. resistive maximum).

The LX switch is available in a low current (LC) switch. Most commonly used in computer operated monitoring systems.

To Order, Specify:

- Standard – Use prefix LX, example LX99EO
- Low Current – Use prefix LX-LC, example LX-LC98EO

Electrical Rating for all Switches:

- Standard – 2 Amp maximum @ 24VDC
- Low Current (LC) - below 50 Milliamps @ 24VDC

Note: All Switches can be either factory or field installed

SS Signal Switch



Monitors pushpad and latch bolt

The SS feature is used to signal the unauthorized use of an opening. This device is equipped with two internal SPDT switches. One switch monitors both the pushpad and the latch bolt assembly, making the latch bolt tamper resistant, for positive security. An additional SPDT switch is connected to the 1¼" (32mm) mortise cylinder with straight cam for alarm "bypass." (Schlage cam reference B502-191). The device can be connected to a security console, or may be used as a single door alarm when used with a horn and power supply.

Pushpad reads: "EMERGENCY EXIT ONLY – PUSH TO OPEN AND SOUND ALARM." Pushpad is only available in US32D finish with red silk-screened lettering.

The SS mortise lock device is furnished with both the signal switch device and the SS7500 mortise lock. The SS7500 mortise lock has the versatility and advantages of the 7500 lock with the addition of signalling functions to monitor latch bolt operation and the trim locking function. The SS7500 mortise lock is supplied standard with the SS mortise lock device.

To Order, Specify:

1. Prefix SS, example SS99L.
2. Handing Required, LHR or RHR.

Electrical Ratings:

Up to 2.0 AMPS @ 24VDC

Popular SS Application

Unauthorized use of this opening will activate the local horn. The key switch permits inhibiting this system for authorized entry.

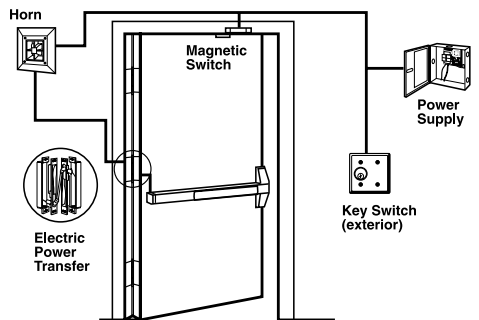

CX The Chexit®

Designed for use on delayed exit applications, the Chexit system is ideal for controlled areas.

All controls, auxiliary locking, local alarm, and remote signalling are self-contained in the Chexit, providing safe, secure, easy to install and simple to operate door control and exit hardware.

Chexit controlled exit device for use on Panic or Fire Exit hardware applications.

This concept in delayed exit systems combines life safety with the needs of security and meets all requirements of NFPA 101 for "Special Locking Arrangement."

The Chexit device includes a 6" x 20" decal for application on door.

"PUSH UNTIL ALARM SOUNDS.
DOOR CAN BE OPENED IN 15 SECONDS"

Minimum width door opening:

- 3' Device 34" opening
- 4' Device 40" opening

Consult factory for other size requirements.

Solenoid Specifications:

- Continuous Duty – 24VDC
- Current Inrush – 16 amperes
- Current Holding – .3 amperes

Requires PS914 Power Supply**Request to Exit Switch:**

Built into the device to detect when someone attempts to exit. Pushing the push pad when the device is armed will cause this switch to start an irreversible alarm cycle.

Nuisance Alarm:

When a Chexit is located in a public area, it can be desirable to limit false alarms. If the Nuisance Delay options are set to off, the device will go into alarm as soon as the push pad is touched (when armed). Turning the Nuisance Delay on will require the push pad to be pressed for 1 second before the Chexit goes into alarm. If the Nuisance Audible and Nuisance Delay are both on, the alarm will sound as soon as the push pad is pressed, but the alarm sequence will stop unless the push pad is held for 1 second or more.

Remote Alarm:

A relay contact is provided to give external alarm indication. This contact closes when the device is in an irreversible alarm condition. This contact can be used to drive a horn, lamp, or other indicative device.

Key Switch:

The Key Switch provides the means to arm, disarm or reset the Chexit. The key can be removed in either the Arm or Disarm position.

Indicator Lamp:

The status of the Chexit can be determined by the indicator lamp. When the lamp is off, this indicates the device is disarmed and is functioning as a normal exit device (no delay). A continuously on lamp indicates the device has just been armed and as soon as the selectable rearm timer expires, the device will arm. A slow flashing lamp indicates the device is armed. A fast flashing indicator lamp indicates the device is in alarm.

Internal Horn:

Whenever the device is in alarm or the push pad is pressed the internal horn will sound. The volume level of this horn exceeds 85 db at 6 feet.

Door Position Input:

An external door position switch can be connected to the Chexit.

Using the door position input ensures that the door is in the closed and latched position before the device rearms.

External Inhibit Input:

This optional input is provided to allow authorized egress of the Chexit in the armed condition. It also allows remote reset of the Chexit in an alarmed condition.

Fire Alarm Input:

This input disables the Chexit immediately upon a fire alarm.

Internal Auxiliary Lock:

The Auxiliary Lock is engaged when the Chexit is armed. The locking mechanism is specifically designed to hold securely even when the exit device is struck with forceful blows.

User Defineable Rearm Time:

The Rearm time is the amount of time after the device is activated before it arms. It is designed to give someone time to pass through the door before rearming occurs. Timing can be changed by the user for any time between 2 and 28 seconds in two second increments. There is also an infinite rearm setting that requires the use of an external door position switch. In this setting the door remains in the rearm mode until the door is closed. This can be useful on jet way doors in an airport.

Factory Defineable Delay Time:

Most jurisdictions allow 15 seconds of delay before allowing egress. In those cases where 15 seconds is not appropriate, Von Duprin can set the Chexit for any delay time between 0 and 60 seconds on 2 second increments. For delays greater than 15 seconds a letter from the local authority is required.

Chexit Typical Application

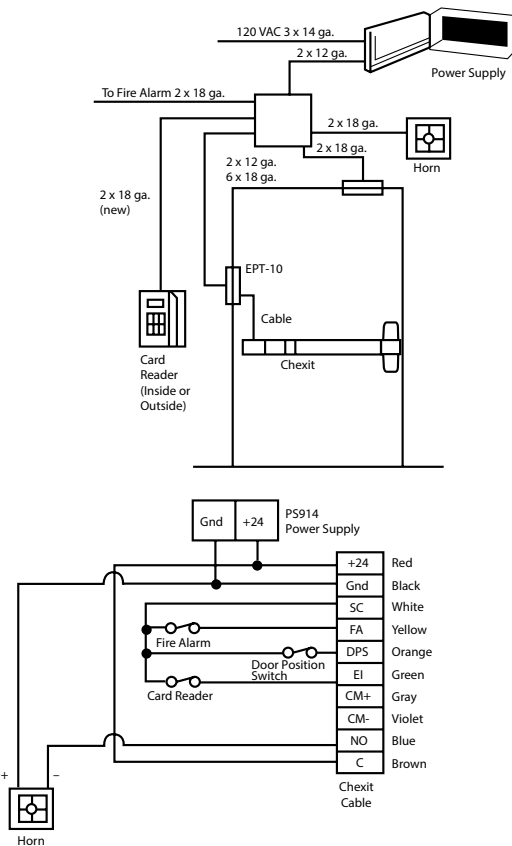

Chexit Single Door with Options – The Chexit is used as an access control device. The card reader allows access. Also shown in this application is an external horn and door position switch. The auxiliary horn is used for increased volume in remote locations. Using a door position switch gives added security to the opening in case the door is not reclosed.

With the Chexit disarmed, the opening functions as a normal exit device. If card readers are required on both sides of the door, the normally closed contacts of the readers should be wired in series.

Note: Chexit rim or vertical rod/cable devices lock any outside trim input when the device is in the armed condition. If access is needed from the trim side of the door, some type of electric switch would need to be tied into the external inhibit input of the device.

Chexit mortise lock device the outside trim works independently from the Chexit device.

Door Width Reference for CX Devices

Device	3' (914mm) Length	4' (1219mm) Length
CX98/98-F/99/99-F	2'10 1/2" (864mm)	3'4 1/2" (1016mm)
CX9875/9875-F/9975/9975-F	2'10" (864mm)	3'4" (1016mm)
CX9827/9827-F/9927/9927-F	2'10" (864mm)	3'4" (1016mm)
CX9857/9857-F/9957/9957-F	2'10" (864mm)	3'4" (1016mm)
CX9847/9847-F/9947/9947-F	2'10" (864mm)	3'4" (1016mm)
CX9848/9848-F/9948/9948-F	2'10" (864mm)	3'4" (1016mm)
CX9849/9849-F/9949/9949-F	2'10" (864mm)	3'4" (1016mm)
CX9849/9849-F/9949/9949-F	2'10" (864mm)	3'4" (1016mm)

ALK Alarm Kit

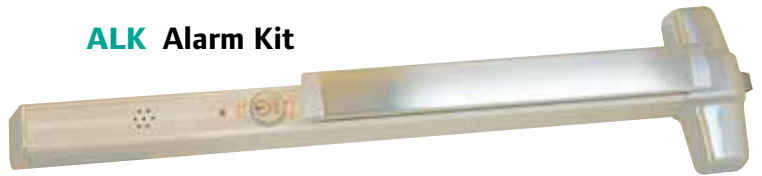

The ALK battery alarm kit is a simple yet effective way to deter unauthorized use of an opening. While the exit device is still a means of egress, the ALK kit contains an internal horn. When the touch bar is depressed, the horn sounds to provide an audible means of signaling that the opening has been violated. The alarm kit can be armed or disarmed by key. The horn is rated at 85 decibel.

For Hardware Applications

The assembly includes both a 24VDC Input and External Inhibit standard. The External Inhibit provides remote arming and dis-arming.

The key switch uses a standard 1 1/4" (32mm) mortise cylinder with a straight cam (Schlage 20-001, B502-191 cam). The unit operates on one standard 9-volt alkaline battery. When the battery is weak, the horn will emit an intermittent low battery alert signal.

The alarm can automatically re-arm with a 1 1/2, 3 or 4 1/2 minute time delay upon request.

Alarm kits are available with a choice of two switch kits, RX or LX. RX monitors the touchpad and is furnished standard. LX optional latch bolt monitoring is recommended for use with surface vertical rod exit devices or when alarm needs to sound from both the exit device and trim side of the door. Specify ALK-LX.

Note: For latch bolt monitoring on a 98/9975 with ALK, specify a SS7500 lock. LX switch not available for 98/9975 devices.

The ALK is available in two styles, 99ALK, grooved cover and 98ALK, smooth cover.

The ALK includes a 6" x 20" decal for application on door "EMERGENCY EXIT ONLY. ALARM WILL SOUND." RSS push bar trim can be used instead of the door decal, specify RSS push bar trim when ordering the device.

When the ALK is used, standard dogging is removed. If cylinder dogging is required there are two choices. Special center case dogging is available or for 3' or 4' doors. The ALK can be moved to the hinge side of the device and standard cylinder dogging can be added.

To Order, Specify:

1. Standard, 98 ALK
2. Cylinder Dogging, CD98 ALK
3. Special Center Case Dogging, SD98 ALK
4. If AR desired, specify AR 1 1/2, 3 or 4 1/2

Minimum Door Opening Sizes on ALK Applications

Device	3' (914mm) Length	4' (1219mm) Length
98/98-F/99/99-F	2'10" (864mm)	3'4" (1016mm)
9875/9875-F/9975/9975-F	2'10" (864mm)	3'4" (1016mm)
9827/9827-F/9927/9927-F	2'10" (864mm)	3'4" (1016mm)
9857/9857-F/9957/9957-F	2'10" (864mm)	3'4" (1016mm)
9847/9847-F/9947/9947-F	2'9" (838mm)	3'3" (991mm)
9848/9848-F/9948/9948-F	2'9" (838mm)	3'3" (991mm)
9849/9849-F/9949/9949-F	2'9" (838mm)	3'3" (991mm)
9849/9849-F/9949/9949-F	2'9" (838mm)	3'3" (991mm)

E Electric Mortise Lock Device



The electric mortise lock device has all the versatility and advantages of the standard mortise lock device, plus the advantage of being electrically controlled by a remote switching device, an access control system or an automatic fire alarm system. The device features the E7500 mortise lock. The E7500 controls the locking of the outside trim. When unlocked, the door remains latched, preserving the fire rating of the door and making it particularly useful where codes permit locking but require unlocking during a fire emergency. The outside trim cylinder retracts the latch bolt for mechanical override, night latch function. Only available with TP, K or L functions.

The E7500 lock contains a SPDT signal to monitor the outside trim condition (locked or unlocked) and a second SPDT signal switch to monitor the latch bolt.

Standard Features:

- Field reversible handing
- 24 VDC continuous duty solenoid

Optional Features:

- Fail safe (locked when energized, unlocked when de-energized or during power failure). Specify with suffix "FS."
- Fail secure (unlocked when energized, locked when de-energized or during power failure). Specify with suffix "FSE"
- 24 VAC (with SO option)
- 12 VDC
- 12 VAC (with SO option)

Note: Some Fire codes will require "Fail Safe" (FS) operation for stairwell doors. Be sure to specify the correct operation for your application.

Electrical Specifications:

- Solenoid — .60 AMPS @ 12VDC
.30 AMPS @ 24VDC
- Each switch — Up to 2.0 AMPS @ 24VDC Maximum

The E option does not include the power transfer from door to frame, the power supply or the control operator. (Refer to EPT-10 and PS902 or PS914 power supply)

To Order, Specify:

1. Use prefix "E," example E9975.
2. FS or FSE
3. Voltage and current.

Electric Mortise Lock Device

Adaptable for openings where continuous latching is required while the trim may be electrically locked or unlocked from a remote location—stairwells, exterior doors, etc.

Minimum System Requirements:

- PS902
- EPT-10

EL Electric Latch Retraction

The EL feature allows for the remote unlatching of exit devices. A control station operator can flip a switch to retract the latch bolt and immediately change an exit door to push-pull operation. A powerful, continuous duty solenoid retracts the latch bolt, either for momentary unlatching, or for extended periods of time. The EL feature is an alternative to manual dogging.

If manual hex-key dogging is required, specify HD-EL. If cylinder dogging is required, the standard cylinder dogging is not available, but special center case dogging is available, specify SD-EL. SD-EL is not available on the 9875 or 9975 devices.

EL devices are also useful with automatic door operators, and may be applied to fire-rated applications when under the control of an **automatic fire alarm system**.

UL approved for Class II circuit applications.

The EL option does not include the power transfer from door to frame, the power supply, or the control operator. Refer to EPT-2 power transfer and the PS914 power supply.

The PS914 with the 9002RS option card is the minimum option card required. Other option cards available for other functions, see PS914 power supply for additional information.

Solenoid Specifications:

Continuous Duty — 24 VDC
 Current Inrush — 16 Amps
 Current Holding — 0.3 Amps

Solenoid Resistance:

-grn-yel 1.2 – 2.2 OHMS
 -grn-org 100 – 150 OHMS

To Order, Specify:

Standard — Use prefix EL, example EL99L.
 Hex Key dogging — Use prefix HD-EL, example HD-EL99L
 Special Center Case Dogging — Use prefix SD-EL, example SD-EL99L

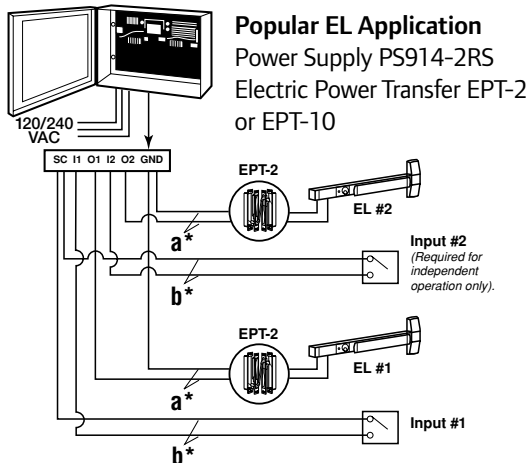

Von Duprin Exit Device	EL Wire Length (feet) ¹	Wire Gauge (AWG)
EL 98/99 Rim	0-500	12
	0-300	14
	0-200	16
All other 98/99EL device types	0-250	12
	0-150	14
	0-100	16
Control Switch	0-1200	18

¹ Wire lengths include an EPT, Door loop, electric hinge or pivot and are measured one way between the PS914/option board and the device.
² Table is applicable to devices that have shipped after August 2012.

QEL Quiet Electric Latch Retraction

The QEL feature allows for the remote unlatching of exit devices. A control station operator can flip a switch to retract the latch bolt and immediately change an exit door to push-pull operation. Different than the popular EL, the QEL quiet operation is achieved using an electric drive motor which retracts the latch bolt either momentary unlatching or for extended periods of time. This feature is an alternative to manual dogging.

If cylinder dogging is required, the standard cylinder dogging is not available, but special center case dogging is available, specify SD-QEL. SD-QEL is not available on the 9875 or 9975 devices.

QEL devices are also useful with automatic door operators, and may be applied to fire-rated applications when under the control of an **automatic fire alarm system**.

UL approved for Class II circuit applications.

The QEL option does not include the power transfer from door to frame, the power supply, or the control operator. Refer to EPT-2 power transfer and the PS902 or 914 power supply.

The PS902/914 with the 2RS, 4RL or 4R board is the minimum required. Other option boards available for other functions, see PS902/914 power supply for additional information.

QEL Electrical Load	
Voltage	24VDC
Current	1.4 A Inrush (0.5 sec.)
	0.14 A Holding
	2.0 A Calibrate (3 sec. one time)

To Order, Specify:

Standard — Use prefix QEL, example QEL99L.
 Special Center Case Dogging — Use prefix SD-QEL, example SD-QEL99L

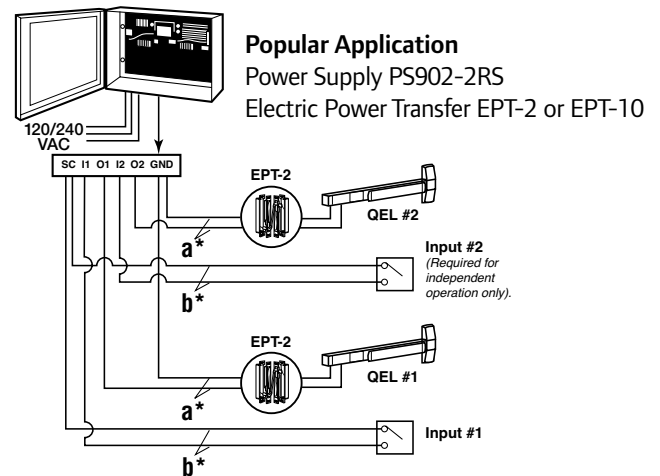

a*

Distance (one-way)	Wire Gauge
200'	18 AWG
320'	16 AWG
500'	14 AWG
800'	12 AWG

b*

Wire Selection	Switch Wire Size
1200 ft. Max.	18 gauge standard

Power Supplies

Series PS902/914



Overview:

The PS900 Series is a consolidated line of power supplies and accessories that offer enhanced flexibility and functionality specific to the changing needs of the access control market. The PS900 Series can be used in a variety of applications to convert high voltage AC power into the low voltage DC outputs required by most access control devices. The PS900 Series protects devices downstream by providing Class 2*, filtered and regulated power. The full line is UL294 certified.

Note: PS906 can provide Class 2 rated outputs when used with 900-8P distribution board.

Features:

- Constant output rating at both 12 VDC and 24 VDC provides superior performance ; includes field selectable jumper
- Polarized connectors for option boards eliminate need for racks and side connectors
- Flat mounting of option boards provides easier access to terminal blocks for connection of electrified devices
- High voltage protective cover
- Battery back-up board auto-selects voltage
- Fire alarm relay can be configured to provide either switched or un-switched outputs from a power supply
- PS914 designed with high in rush current for powering electrified panic devices
- Universal 120-240 VAC input
- Low voltage DC, regulated and filtered
- Electronic power limiting foldback circuit for AC current overload protection
- Fused primary input
- AC status monitor- isolated SPDT contacts
- AC input and DC output LED status indicators
- Cover mounted AC input indication
- Hinged cover with lock down screws

Certifications:

- UL 294 certified—the standard for access control
- Class 2 rated*

** Except PS906, output rating exceeds Class 2 power limits*

Once power is converted to low voltage DC, the PS900 Series offers a variety of distribution options, including basic fuse protection, simple relay, and advanced logic providing complex sequencing and timing functions.

** PS906 can provide Class 2 rated outputs when used with 900-8P distribution board.*

	PS902	PS904	PS906	PS914
Number of Connectors on Power Supply for the following:	2 amps	4 amps	6 amps	4 amps
Distribution Boards	1	2	3	2
Battery Back-up Board	1	1	1	1

Note: One fire alarm board can be connected directly to the PS902. If a fire alarm board is desired for the PS904, PS906 or PS914 it can be connected to a distribution board.

Applications:

The PS900 Series of power supplies works with many electrified devices including Schlage electromagnetic locks, Schlage AD-Series hardwired locks, Schlage electrified mechanical locks, Von Duprin electrified strikes , Von Duprin exit devices, and many other brands.

Accessories:

The Schlage PS900 Series features seven option boards for use in a variety of applications. All Schlage PS900 Series power supplies option boards are UL 294 certified.

Option Boards:

900-4R: 4 relay controlled output board to power multiple devices

900-4RL: 4 relay distribution board with logic is field configurable for time delay function, auto operator, security interlock

900-8F: Provides 8 individually fuse-protected outputs, giving the flexibility to power multiple devices and provide another layer of protection

900-FA: Emergency interface relay integrates with fire alarm and is used to cut power in case of emergency

900-BB: Battery backup

900-2RS: 2 relay EL panic device control board (PS914 only)

900-BBK: Battery backup kit includes two 7A/hr batteries and provides up to four hours of backup power when cycled every 5 minutes at full load

EPT Electrical Power Transfer

PNT Pneumatic Transfer

Electric Power Transfer provides a means of transferring electrical power from a door frame to the edge of a swinging door. The units are completely concealed when the door is in the closed position, and are ideal for installations involving abuse or heavy traffic.

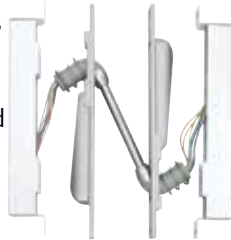

Two models are available; EPT-2, two 18 gauge wires and EPT-10, ten 24 gauge wires. The EPT-2 and EPT-10 are U/L listed as “miscellaneous door accessory”.

UL Listed for use on fire doors

Door applications:

- up to 5" butt hinges – 180° swing,
- 5½" butt hinges – 130° swing,
- 6" butt hinges – 110° swing,
- ¾" butt offset pivots 180° swing.

Not for use with swing clear hinges or center-hung pivots.

Finishes

- SP28 (sprayed aluminum)
- SP313 (sprayed duranodic).

Dimensions

Housing	9" x 1¼" x 1⅝" (229mm x 32mm x 38mm)
EPT-2	Two 18 gauge wires, Up to 2 AMPS @ 24VDC, with a 16 AMPS Maximum Surge
EPT-10	Ten 24 gauge wires, Up to 1 AMPS @ 24VDC, with a 16 AMPS Maximum Surge
PNT-1	⅝" Tubing

To order, specify:

1. EPT-2 ,EPT-10 or PNT-1.
2. Finish, SP28 or SP313.

E996L Electrified Breakaway Lever



E996L electrified lever trim provides remote locking and unlocking. Furnished standard in fail safe (FS) condition, can be field converted to fail secure (FSE) where allowed.

E996L is furnished standard with cylinder operation for nightlatch (NL) function, or with blank escutcheon (BE).

XP Extra Performance

For increased security the XP98/99 Rim Exit Device has a static load force resistance of more than 2,000 pounds, twice that of standard rim exit devices.

The two-piece latch bolt forms a 90° latch-to-strike contact. The "smart" latch changes shape when subjected to external forces. This design enables the exit door to withstand an external attack and remain secure. Additionally, the patented latch bolt design provides a greater, longer-lasting latch bolt to strike contact which is not easily affected by the twisting motion of a weakened frame, resulting in an opening that will remain strong.

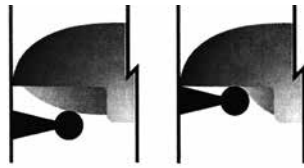

With a door loaded to 250 pounds, XP98/99 requires less than 40 pounds of pressure to open, 25% less than the safety code requires.

XP98/99 is available for panic or fire exit hardware applications. Dimensions, finishes and trim options are equal to the standard 98/99 series rim exit device.

Note: The 909 strike is to be used for all applications. The exception occurs with the use of fire rated double door applications, in this instance the 954 strike is required.

To order, specify: Use prefix XP, example XP99EO.

WS Surface Vertical Rod Exit Device

WS9827/9927 Surface Vertical Rod exit device designed, tested and certified to comply with ICC 500 Standard for the Design and Construction of Storm Shelters, and the Federal Emergency Management Agency's publication FEMA 361 - Design and Construction Guidance for Community Safe Rooms.

Dimensionally the device matches with the standard 98/99 surface vertical rod exit device, and is listed with Steelcraft Paladin™ PW-Series doors for tornados, and Steelcraft H-Series doors hurricane applications.

UL Listed – Panic hardware UL 305; and Fire exit hardware UL 10C; 3 hour pairs of doors double egress, 90 minutes swinging same direction. 8'0" x 8'0" (2438mm x 2438mm).

BHMA Grade 1, ANSI A156.3-2001g1

Windstorm ratings:

Door applications - 8'0" x 8'0" (2438mm x 2438mm) pairs swinging same direction and 4'0" x 8'0" (1219mm x 2438mm) single non-fire rated flush hollow metal.

Miami-Dade County/FBC compliance to TAS 201, TAS 202, TAS203 (NOA pending); design load rating +150/-150 PSF (245 MPH wind zone); Enhanced Hurricane Protection (EHPA) ASTM E1996, ANSI/ICC 500 (245 MPH wind zone).

UL-FEMA 361 certified 8'0" x 8'0" (2438mm x 2438mm) pairs swinging same direction and 4'0" x 8'0" (1219mm x 2438mm) single non-fire rated flush hollow metal.

UL-ANSI/ICC 500 certified for F5 tornado applications.

To order, specify:

WS prefix, example WS9927-F

LBR Less Bottom Rod, Panic and Fire Rated

LBR option is available, using a spring loaded auxiliary latch bolt installed in the lower door edge. When exposed to heat the auxiliary latch bolt releases, keeping the doors in alignment and closed during a fire. UL listed 3 hours on hollow metal doors double egress, 90 minute swinging same direction, and 20 minutes wood doors (consult wood door manufacturer). Fits door stiles as narrow as 3/8".

LBR devices must be ordered in pairs or must be used in conjunction with an approved automatic or constant latching flush bolt.

PL Pullman Latch

When PL is specified the standard latches are replaced with pullman style latches. Pullman latches are always extended and are most commonly used in conjunction with electric strikes and LBR-less bottom rod application. Not available with Fire rated devices. Not recommended where security is of the utmost importance since latches do not deadlock.

Dummy Pushpad



The 330 dummy pushpad is designed as a companion unit for all 99 devices. The 350 dummy pushpad is a companion unit for all 98 devices. The pushpad is rigid or nonfunctioning. A push/pull operation can be accomplished by using 990DT, 996DT trim or any Ives Pull.

The 330/350 can be equipped with a functional pushpad and will accommodate an RX or WP-RX switch. Specify RX-330. May also be equipped with the RX2, double RX switch. Specify RX2-330

To order, specify:

1. 330 or 350.
2. Size 3' or 4' (914mm or 1219mm)
3. Finish, US3, US4, US10, US26, US26D, US28, 313 & 315. US32D – 350 only.
4. Specify RX, WP-RX or RX-2 if desired.

SG Safety Glow



Self-illuminating touchpad defines the location of the exit door in dark or smoke-filled area. The Safety Glow coating is a special powder coat finish that glows brightly during low or no light conditions. This coating was developed to meet MEA standards where luminescent exit door markings are required in commercial facilities. There are no batteries or electronics, the coating is charged when exposed to light.

To order, specify: Suffix SG, EL 9927L-SG

Braille, Embossed and Knurled Touchpads



Braille touchpad embossed with the standard message "CAUTION STAIRWELL" in braille and raised letters provides assistance to persons with impaired vision. Letters are 1/2" (13mm) high and braille is #2, raised height is 3/32" (2mm). Other messages are available on special order, limited to 20 characters per line.* - To order, specify: Suffix BR, EL9927L-BR

Embossed touchpad is embossed with the word "PUSH". - To order, specify: Suffix EMB, EL9927L-EMB

Knurled touchpad is to provide warning to persons with impaired vision. - To order, specify: Suffix PBKN, EL9927L-PBKN

Consult factory for availability.

RSS Red Silk Screen



Red silkscreen lettering on touchpad trim. - "Emergency Exit Only, Push To Open And Sound Alarm". This comes standard on SS devices.

To order, specify: Suffix RSS, 9927L-RSS RHR

PN Pneumatic Controlled Exit Devices



The PN feature provides remote latch bolt retraction in hazardous areas where electrically operated devices would not be permitted. The pneumatic solenoid will retract the latch bolt for momentary or prolonged periods. PN exit devices are particularly suited for use with automatic door operators. The PN feature is available on both Panic and Fire Exit Hardware devices.

The PN feature includes a special actuating linkage that gives building owners the option of mechanically or pneumatically dogging the exit device. If manual hex-key dogging is required, specify HD-PN (Dogging the device, whether mechanically or pneumatically, makes the device function as a push/pull unit and reduces the wear on its moving parts.) If cylinder dogging is required, the standard cylinder dogging is not available, but special center case dogging is available, specify SD-PN. SD-PN is not available on the 9875 or 9975 devices.

When activated pneumatically, the latch bolt(s) of the exit device retract in ½ to 1½ seconds. This pneumatic operation uses air pressure ranging from 50 to 100 pounds per square inch.

This product will function only when it is part of a pneumatic system (air compressor, air lines, pneumatic system, etc.). Contact LCN for correct control boxes.

To Order, Specify:

- Standard — Use prefix PN, example PN99NL
- Hex Key Dogging — Use prefix HD-PN, example HD-PN99NL
- Special Center Case Dogging (handing is required, specify RHR or LHR) — Use prefix SD-PN, example SD-PN99NL

PNT Pneumatic Transfer

Pneumatic Controls

PNT-1 is available for pneumatic latch retraction exit devices. Appearance and dimensions are identical to EPT models.

RG-27 Vertical Rod and Latch Guard

Series RG-27 Vertical Rod and Latch Guards protect the bottom rods of exit devices from the damaging impacts of carts or gurneys passing through doors. (If bottom rods become damaged, the exit device will not function as intended and can jeopardize the ability to exit safely during an emergency.)

In addition to protecting the vertical rod, the guard provides a smooth, unobstructed surface so the door can be pushed open easily with the bumpers of a wheelchair. The latch guard portion is 10" high. The standard latch guard features a 45° ramp. The extended latch guard offers a continuous ramp in 3' or 4' widths.

All stainless steel construction in US32D finish. Latch guards can cover latches as large as 1 1/4"W x 10"H x 1 7/8" projection.

Rod Guard

Latch Guard



Extended Latch Guard

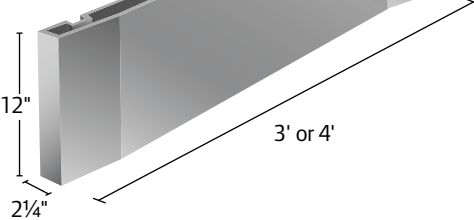

Models

- RGO** Rod guard only (Projection 1 3/16")
- RG-27** Rod and latch guard
- RG-27-3** 3' (914mm) Rod Guard and Extended Latch Guard
- RG-27-4** 4' (1219mm) Rod Guard and Extended Latch Guard
- LGO** Latch guard only
- LGO-3** 3' (914mm) Extended latch guard only
- LGO-4** 4' (1219mm) Extended latch guard only

When using on wood fire doors, High Density Block is required.

To Order, Specify:

1. Model number.
2. Handing (except on RGO).
3. Door material if other than Hollow Metal.
4. Optional sex bolt mounting available.

997 Cover Plate Kit

For 98/99 rim device, kit contains inside and outside plates for hinge stile cutouts, an inside plate for the lock stile, and necessary screws. Plates are designed to cover cutouts required by most existing exit device installations. Specify finish.

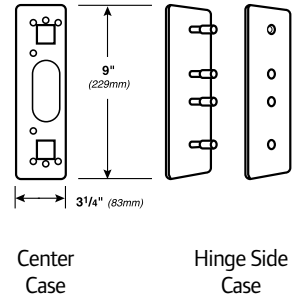

WDA Cover Plate Kit

For wood door applications, used to cover up door preparations for control, also prevents the control from boring into the wood door. Finished to match control.



GBK Glass Bead Kit

Glass bead conversion kits are available for all 98/99™ Series devices for use on doors with raised glass beads. Each kit consists of 1/4" (6mm) shim sets. GBK for Surface Vertical Rod ships with 1/8" shims for rod guides.

To order, specify:

1. 99GBK
2. Device type (Rim, Mortise, Surface Vertical Rod, Concealed Vertical Rod)
3. Wood Door, when used with Concealed Vertical Rod
4. When used with 330/350 Dummy Pusher, order two hinge stile shims.

Cylinders

Cylinders are not furnished with device or trim and must be specified when ordering. Refer to trim pages for cylinder type.



Mortise — 3215 (Schlage 20-001, B502-191 cam)

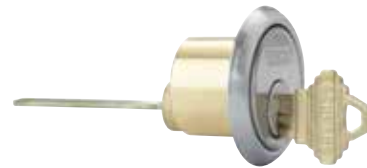
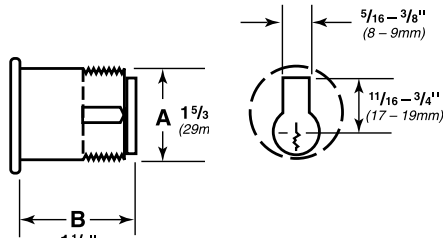

Rim — 3216 (Schlage 20-022 cam)

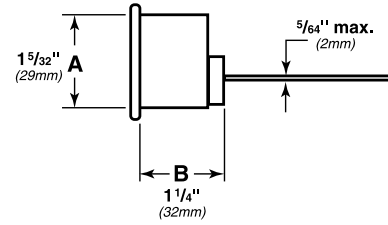

Dogged (Inverted) Cam

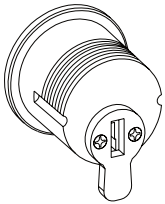

For Cylinder Dogging
Special Dogging

Undogged Cam (Standard Operations)

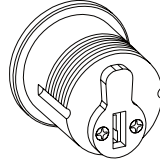

For Standard Trim Functions

Mullions

Removable Steel Mullions provide single door performance in double door openings with rim devices. Mullions are easily removed by loosening bottom set screw and removing top fitting cover. The top mullion fitting is attached to the frame and is concealed by the fitting cover.

Steel mullions are 2" (51mm) wide and 3" (76mm) deep, with a wall thickness of 1/8" (3mm).

Mullions are shipped with mounting screws and prepared for strikes. Strikes are not included except where indicated.

Steel mullions are available in SP28 and SP313 finishes. Consult factory for other powder coat finish options.

KR – Keyed Removable Steel Mullions make removal faster and easier by a single operation of the mortise cylinder. Once mullion is removed, large equipment or furniture can freely pass through the opening. The unit will self lock when re-installed, without the use of the cylinder key. Uses a 1 1/4" mortise cylinder with a straight cam (Schlage cam reference B502-191). Cylinders are sold separately. Prefix mullion model with "KR".

Removable Aluminum Mullions are 1 1/16" (27mm) wide on face closest to the door and 2 3/8" (60mm) at the widest point. The depth is 3 1/8" (79mm) with a wall thickness of 1/8" (3mm).

Aluminum mullions are available in US4, US10, US28, 313 and 315 finishes. Consult factory for other powder coat finish options. Aluminum mullion are not available keyed removable.

Stock Hollow Metal Applications for devices mounted to cover ANSI 161 cutouts are higher than the standard mullion strike location. Consult the factory for special strike preparation or order a blank mullion. See below.

Blank Mullions are furnished without strike preparation. They are used to mount devices at a strike height different from the standard mullion preparation.

To order, specify:

1. For keyed Removable option on steel mullions, prefix model number with "KR"
2. Model number
3. Height of opening
4. Finish
5. Handing if required
6. Centerline deviation (refer to device template for standard centerline)
7. Strikes, when required, should be ordered with device

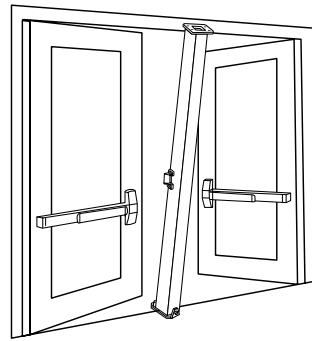

Removable Mullions

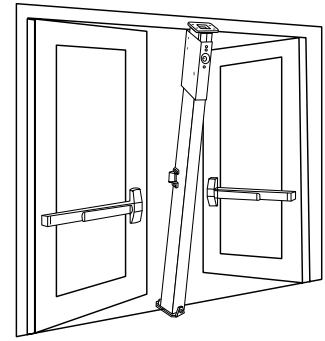

Keyed Removable Steel Mullions

Steel Mullions

1654 Prepared for two 1606 strikes. **If 1606 strikes are not specified on the order, two per mullion will be added. Additional charges apply.**

4954 Prepared for 264 or 299 strikes. For use with all Von Duprin Panic rim devices. **Note: specify strike choice with device.**



9954 Prepared for and must be used with two 268 strikes (88-F device), or two 499F (22-F, 98-F, 99F devices). UL fire labeled mullion for up to 3 hour opening using Von Duprin fire exit rim devices. This mullion is not easily removed due to special fittings.

98-F and 99-F devices are rated up to 10'0" (3048 mm).

Note: If 268 or 499F strikes are not specified on the order, two per mullion will be added. Additional charges apply.

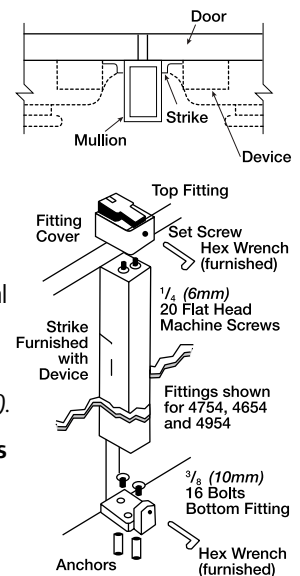

4754 Prepared for two 4263 monitor strikes.

4854 Prepared for one 299 and one 6111 electric strike. Indicate handing for electric strike.



9854 Prepared for one 268 or 499F strike and one 6111 electric strike. Indicate handing for electric strike. UL fire labelled mullion for up to 3 hour openings up to 8' x 8' (2438mm x 2438mm) using Von Duprin Fire Exit Rim Devices

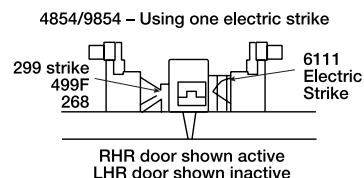

Sex Bolts

Sex Bolts when ordered with devices may be furnished with screw lengths different than shown in Column B. Below, Column B indicates popular sizes. Sex Bolts ordered separately are not furnished with screws. If screws are required refer to chart below and order screws by description as a separate item. Other screw lengths may be used based on minimum and maximum allowable thread engagement, shown in column "C." Quantity required — refer to device section, quantities differ depending on outside trim.

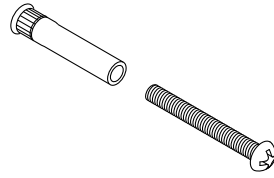

325 sex bolts used on surface Vertical Latches.

425 sex bolts are required for 98/99 Series fire rated devices when used on wood door applications. When wood doors are specified for these devices, sex bolts will be added to the device application unless SLM blocking package is specified.

825 sex bolts are required with 98-F/99-F rim devices on wood door applications using NL, TP, K and L outside trims. Two 825 sex bolts will be added to the device application unless SLM blocking package is specified.

To order, specify:

1. Model number
2. Quantity (2 per package)
3. Finish
4. Door thickness other than 1¾" (44mm)



Rim, Mortise and Concealed Vertical

Device Type	Door Thickness	Center Case				Hinge Case			
		Sex Bolt			C Thread Engagement Min. – Max	Sex Bolt			C Thread Engagement Min. – Max
		No.	A	B Screw		No.	A	B Screw	
98, 9827, 9827-F, 9875, 9875-F, 9847, 9847-F, 9847WDC, 9849, 9849-F, 99, 9927, 9927-F, 9975, 9975-F, 9947, 9947-F, 9949, 9949F, 98/9949WDC, 98/9949WDC-F	1¾" (44mm)	425	1 ⁹ / ₁₆ "	10-24 x 1" PPHMS	9/ ₃₂ " – 5/ ₈ "	425	1 ⁹ / ₁₆ "	10-24 x 1" PPHMS	9/ ₃₂ " – 5/ ₈ "
	2¼" (57mm)	425	1 ⁹ / ₁₆ "	10-24 x 1½" PPHMS	9/ ₃₂ " – 5/ ₈ "	425	1 ⁹ / ₁₆ "	10-24 x 1½" PPHMS	9/ ₃₂ " – 5/ ₈ "
98-F, 99-F*	1¾" (44mm)	425 825A*	1 ⁹ / ₁₆ " 1 ¹³ / ₁₆ "	10-24 x 1" PPHMS 10-24 x ¾" PPHMS	9/ ₃₂ " – 5/ ₈ "	425	1 ⁹ / ₁₆ "	10-24 x ¾" PPHMS	9/ ₃₂ " – 5/ ₈ "
	2¼" (57mm)	425 825B*	1 ⁹ / ₁₆ " 2 ⁵ / ₁₆ "	10-24 x 1½" PPHMS 10-24 x ¾" PPHMS	9/ ₃₂ " – 5/ ₈ "	425	1 ⁹ / ₁₆ "	10-24 x 1¼" PPHMS	9/ ₃₂ " – 5/ ₈ "

* For use with outside trims, see page XX for details

Surface Vertical Rod - Latches Only

Device Type	Door Thickness	Latch Cases		
		Sex Bolt (supplied)		
		No.	A	B Screw
9827/9927/9827F, 9927F,	1¾" (44mm)	325	1 ⁹ / ₁₆ "	1/4 – 20 x ¾" FPHMS
	2¼" (57mm)	325	1 ⁹ / ₁₆ "	1/4 – 20 x 1¼" FPHMS

PPHMS – Pan Phillips Head Machine Screw UFPHMS – Undercut Flat Phillips Head Machine Screw

* For use with outside trims.

ANSI Function, Grade & Type

Function	Grade 1, Type 1	Grade 1, Type 2	Grade 1, Type 3	Grade 1, Type 7	Grade 1, Type 7	Grade 1, Type 8	Grade 1, Type 8	Grade 1, Type 8	Grade 1, Type 9
1	98EO & F 99EO & F	9827EO & F 9927EO & F	9875EO & F 9975EO & F	9847WDCEO & F 9947WDCEO & F	9849WDCEO & F 9949WDCEO & F	9847EO & F 9947EO & F	9848EO & F 9948EO & F	9849EO & F 9949EO & F	9857EO & F 9957EO & F
2	98DT 99DT	9827DT 9927DT	9875DT 9975DT	9847WDCDT 9947WDCDT	9849WDCDT 9949WDCDT	9847DT 9947DT	9848DT 9948DT	9849DT 9949DT	9857DT 9957DT
3	98NL & F 99NL & F	9827NL & F 9927NL & F	9875NL & F 9975NL & F	9847WDCNL & F 9947WDCNL & F	9849WDCNL & F 9949WDCNL & F	9847NL & F 9947NL & F	9848NL & F 9948NL & F	9849NL & F 9949NL & F	9857NL & F 9957NL & F
3	98K-NL & F 99K-NL & F	9827K-NL & F 9927K-NL & F	9875K-NL & F 9975K-NL & F	9847WDCK-NL & F 9947WDCK-NL & F	9849WDCK-NL & F 9949WDCK-NL & F	9847K-NL & F 9947K-NL & F	9848K-NL & F 9948K-NL & F	9849K-NL & F 9949K-NL & F	9857K-NL & F 9957K-NL & F
3	98L-NL & F 99L-NL & F	9827L-NL & F 9927L-NL & F	9875L-NL & F 9975L-NL & F	9847WDCL-NL & F 9947WDCL-NL & F	9849WDCL-NL & F 9949WDCL-NL & F	9847L-NL & F 9947L-NL & F	9848L-NL & F 9948L-NL & F	9849L-NL & F 9949L-NL & F	9857L-NL & F 9957L-NL & F
5	98TP & F 99TP & F	9827TP & F 9927TP & F	9875TP & F 9975TP & F	9847WDCTP & F 9947WDCTP & F	9849WDCTP & F 9949WDCTP & F	9847TP & F 9947TP & F	9848TP & F 9948TP & F	9849TP & F 9949TP & F	9857TP & F 9957TP & F
7	98TP-2 & F 99TP-2 & F		9875TP-2 & F 9975TP-2 & F						
8	98K & F 99K & F	9827K & F 9927K & F	9875K & F 9975K & F	9847WDCK & F 9947WDCK & F	9849WDCK & F 9949WDCK & F	9847K & F 9947K & F	9848K & F 9948K & F	9849K & F 9949K & F	9857K & F 9957K & F
8	98L & F 99L & F	9827L & F 9927L & F	9875L & F 9975L & F	9847WDCL & F 9947WDCL & F	9849WDCL & F 9949WDCL & F	9847L & F 9947L & F	9848L & F 9948L & F	9849L & F 9949L & F	9857L & F 9957L & F
10	98K-2 & F 99K-2 & F		9875K-2 & F 9975K-2 & F						
10	98L-2 & F 99L-2 & F		9875L-2 & F 9975L-2 & F						
11 12		9827TL & F 9927TL & F		9847WDC & F 9947WDC & F	9849WDC & F 9949WDC & F	9847TL & F 9947TL & F	9848 & F 9948 & F	9849 & F 9949 & F	9857TL & F 9957TL & F
14	98K-BE & F 99K-BE & F	9827K-BE & F 9927K-BE & F	9875K-BE & F 9975K-BE & F	9847WDCK-BE & F 9947WDCK-BE & F	9849WDCK-BE & F 9949WDCK-BE & F	9847K-BE & F 9947K-BE & F	9848K-BE & F 9948K-BE & F	9849K-BE & F 9949K-BE & F	9857K-BE & F 9957K-BE & F
14	98L-BE & F 99L-BE & F	9827L-BE & F 9927L-BE & F	9875L-BE & F 9975L-BE & F	9847WDCL-BE & F 9947WDCL-BE & F	9849WDCL-BE & F 9949WDCL-BE & F	9847L-BE & F 9947L-BE & F	9848L-BE & F 9948L-BE & F	9849L-BE & F 9949L-BE & F	9857L-BE & F 9957L-BE & F
16		9827TL-BE & F 9927TL-BE & F		9847WDC & F 9947WDC & F	9849WDC & F 9949WDC & F	9847TL-BE & F 9947TL-BE & F	9848 & F 9948 & F	9849 & F 9949 & F	9857TL-BE & F 9957TL-BE & F

Dimensions

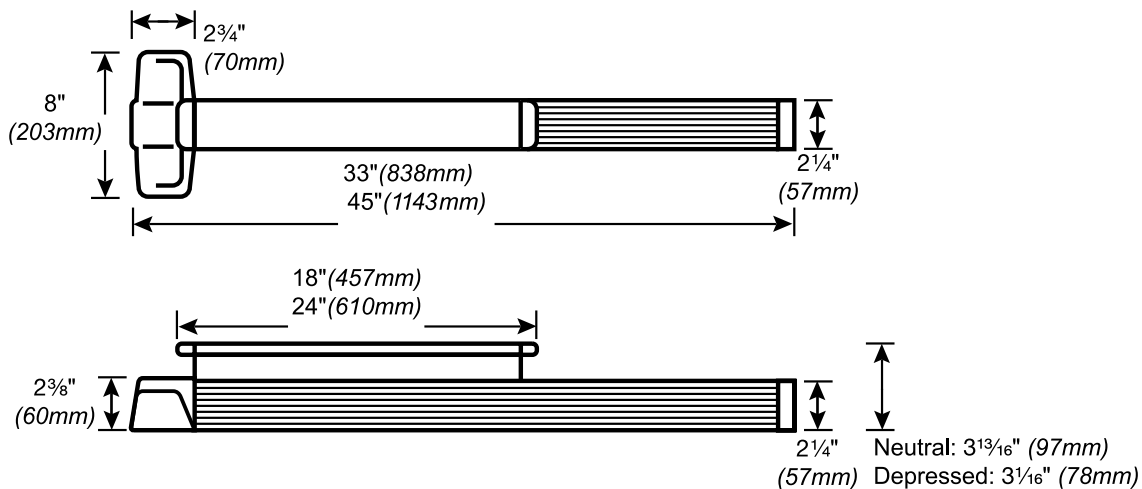

UL Listed Fire Exit Hardware Label and Opening Size

Exit Device	Door Material	Single Door	Double Door						
			With 9954 Mullion	With 9854 Mullion	With KR9954 Mullion	With KR9854 Mullion	V x V Same Direction	V x Mortise Same Direction	V x V Double Egress
98-F 99-F	Metal	3 Hour 4' x 10'	3 Hour 8' x 10'	3 Hour 8' x 10'	3 Hour 8' x 8'	3 Hour 8' x 8'	—	—	—
9875-F 9975-F	Metal	3 Hour 4' x 10'	—	—	—	—	—	3 Hour 8' x 10'	—
9827-F 9927-F	Metal	—	—	—	—	—	90 Minute* 8' x 10'	3 Hour 8' x 10'	3 Hour 8' x 10'
9827LBR-F 9927LBR-F	Metal	—	—	—	—	—	90 Minute* 8' x 10'	—	3 Hour 8' x 10'
9857-F 9957-F	Metal	3 Hour 4' x 8'	3 Hour 8' x 8'	3 Hour 8' x 8'	3 Hour 8' x 8'	3 Hour 8' x 8'	—	—	—
9847-F 9947-F	Metal	—	—	—	—	—	90 Minute* 8' x 10'	3 Hour 8' x 10'	3 Hour 8' x 10'
9847LBR-F 9947LBR-F	Metal	—	—	—	—	—	90 Minute* 8' x 10'	—	3 Hour 8' x 10'
9848-F 9948-F	Metal	—	—	—	—	—	90 Minute* 8' x 10'	3 Hour 8' x 10'	3 Hour 8' x 10'
9849-F 9949-F	Metal	—	—	—	—	—	90 Minute* 8' x 10'	3 Hour 8' x 10'	3 Hour 8' x 10'
9849LBR-F 9949LBR-F	Metal	—	—	—	—	—	90 Minute* 8' x 10'	—	3 Hour 8' x 10'

* Currently, no door manufacturers offer a listing over 90 minutes with doors swinging same direction.
Consult wood door manufacturers for current UL listings.

98/99 Finishes

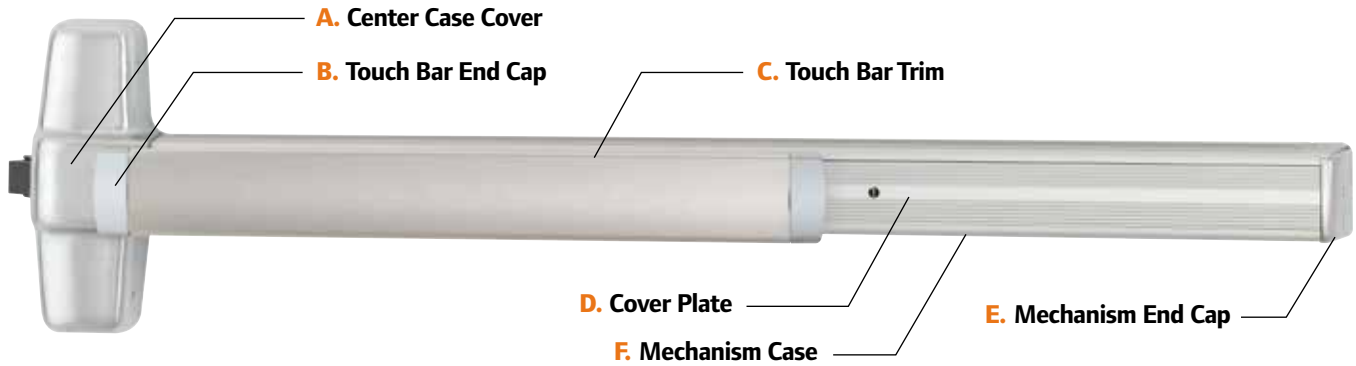

Finishes

Color	US Number	BHMA Number	A, B, E	C	D & F
Bright Brass	US3	605	Bright Brass	Bright Brass US3, 605	Buffed Anodized
Satin Brass	US4	606	Bright Brass	Satin Brass US4, 606	Anodized
Satin Bronze	US10	612	Plated	Satin Bronze US10, 612	Anodized
Bright Chrome	US26	625	Plated	Bright Stainless Steel US32, 629	Buffed Anodized
Satin Chrome	US26D	626	Plated	Satin Stainless Steel US32D, 630	Anodized
Satin Stainless Steel*	US32D	630	Stainless Steel	Satin Stainless Steel US32D, 630	Anodized
Aluminum, Anodized	US28	628	Powder Coat	Satin Stainless Steel US32D, 630	Anodized
Duranodic Dark Bronze	313	710	Powder Coat	Powder Coat	Powder Coat
Black	315	622	Powder Coat	Powder Coat	Powder Coat

Special Finishes

Color	US Number	BHMA Number	A, B, E	C	D & F
Satin Bronze, Oil-Rubbed	US10B	613	Oil-Rubbed, US10B	Oil-Rubbed, US10B	Powder Coat
Powder Coat**	RAL #	–	Powder Coat	Satin Stainless Steel US32D, 630 (unless specified to match device)	Powder Coat
Bright Bronze	US9	611	Plated	Bright Bronze US9, 611	Buffed Anodized
Satin Nickel *	US15	619	Plated, Clear Powder	Satin Stainless Steel US32D	Anodized
Aged Bronze 643E	–	–	Relieved Aged Bronze	Relieved Aged Bronze	Aged Bronze, No Relief
Satin Chrome (Antimicrobial)	U26D-AM	626-AM	AM Clear over Chrome	AM Clear over Satin Stainless Steel US32D, 630	AM Clear over Anodized
Satin Stainless Steel (Antimicrobial)	US32D-AM	630-AM	AM Clear over Stainless Steel	AM Clear over Satin Stainless Steel US32D, 630	AM Clear over Anodized

Touch Bar Trim Options:

Knurled

Embossed “Push”

Braille, US32D Only, Embossed “Caution Stairwell”

RSS, US32D Only, Red silk screen lettered “EMERGENCY EXIT ONLY – PUSH TO OPEN AND SOUND ALARM.”

* US32D and US15—available on 98 Series only

** Other custom logo touchbar trim and RAL color combinations available - consult factory

Finishes*

	Color	US Number	BHMA Number
	Chromium, Polished	US26	625
	Anodized, Aluminum	US28	628
	Chromium, Dull	US26D	626
	Brass, Polished	US3	605
	Brass, Dull	US4	606

	Color	US Number	BHMA Number
	Bronze, Dull	US10	612
	Satin Nickel <i>Available for 35A ONLY</i>	US15	619
	Satin Stainless Steel	US32D	630
	Duranodic Dark Bronze	313	710
	Black	315	711

Special Finishes

	Color	US Number	BHMA Number
	Satin Chrome, Antimicrobial	US26D-AM	626-AM
	Satin Stainless Steel, Antimicrobial	US32D-AM	630-AM
	Aged Bronze 643e	-	-

Pushpad Options — Knurled
 Embossed "Push"
 Braille (Caution-Stairwell), satin stainless steel only
 RSS – (Emergency Exit – Push to open and sound alarm) – Red Silkscreen lettering on US32D

* **NOTE:** Durable powder coated finishes available at specific special request. PLEASE CONTACT FACTORY.



Ingersoll Rand (NYSE:IR) advances the quality of life by creating and sustaining safe, comfortable and efficient environments. Our people and our family of brands—including Club Car®, Ingersoll Rand®, Schlage®, Thermo King® and Trane®—work together to enhance the quality and comfort of air in homes and buildings; transport and protect food and perishables; secure homes and commercial properties; and increase industrial productivity and efficiency. Ingersoll Rand Security Technologies' market-leading products include electronic and biometric access control systems; time-and-attendance and personnel scheduling systems; mechanical locks; portable security; door closers, exit devices, architectural hardware, and steel doors and frames; and other technologies and services for global security markets. Ingersoll Rand is a \$14 billion global business committed to a world of sustainable progress and enduring results.

securitytechnologies.ingersollrand.com

ingersollrand.com