

# VON DUPRIN®

## Installation Instructions

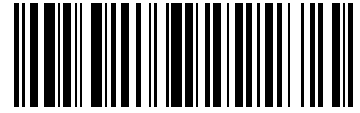

931240-00

### STRIKEFORCE® 6224/6224DS Electric Strike



#### Double Door Closed Back Mortise or Cylindrical Application

**Notes:** Deadbolt will not function with this strike.  
Check with factory for retrofit applications.

- For lock or device preparation, see their directions.
- Prepare door for strike (see other side).
- Wire strike (Figure 1). (Switches on 6224DS only.)
- Test strike: Apply solenoid power. Fail secure (FSE) lip unlocks. Fail safe (FS) lip locks. Figure 1 shows status of switches.
- Install strike with two #12-24 screws. Make sure clearance between latch bolt and strike lip is 1/32" (Figure 2). If not, uninstall strike, adjust (Figure 3), and reinstall.
- If latch bolt does not extend far enough to actuate tripper, install extension (Figure 4). (Tripper on 6224DS only.)

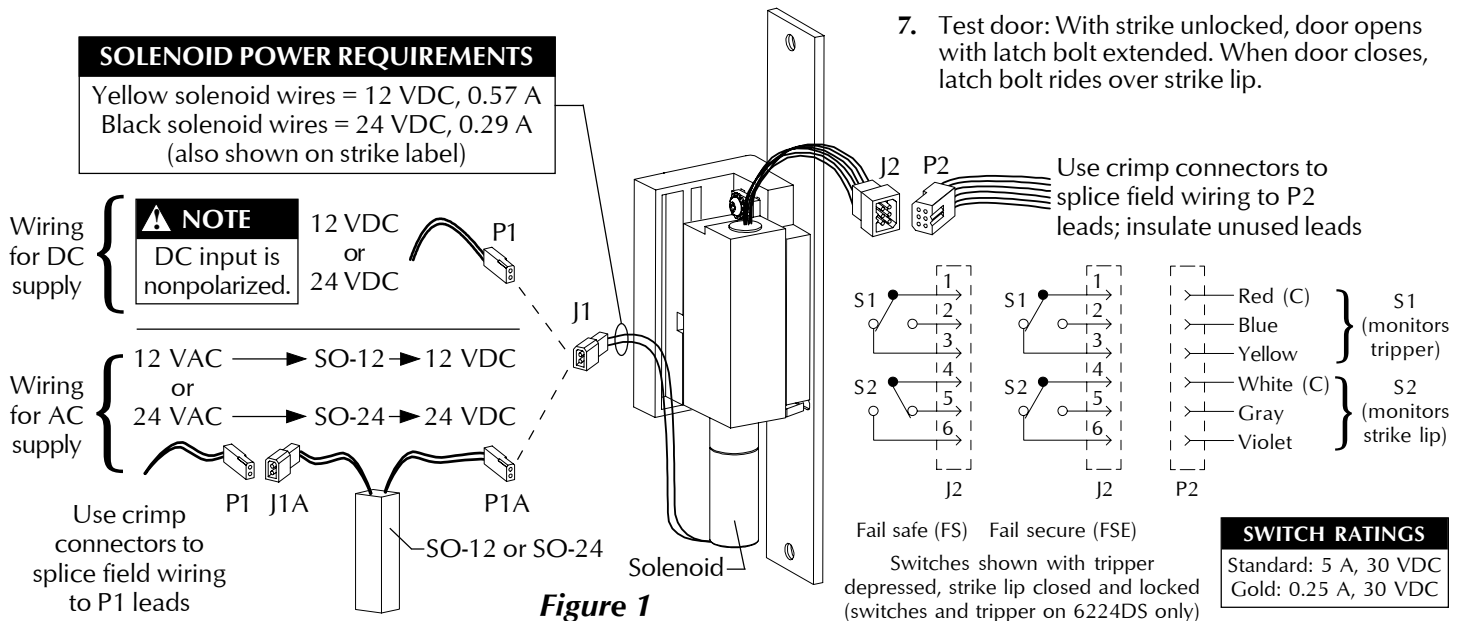

Figure 1

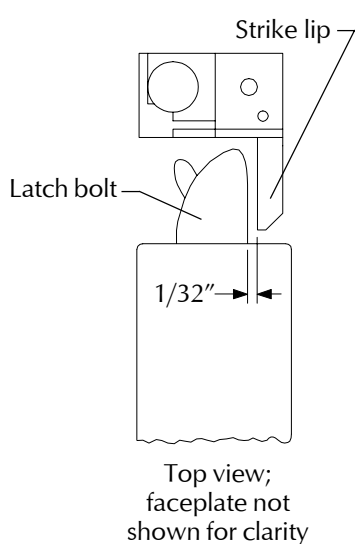

Figure 2

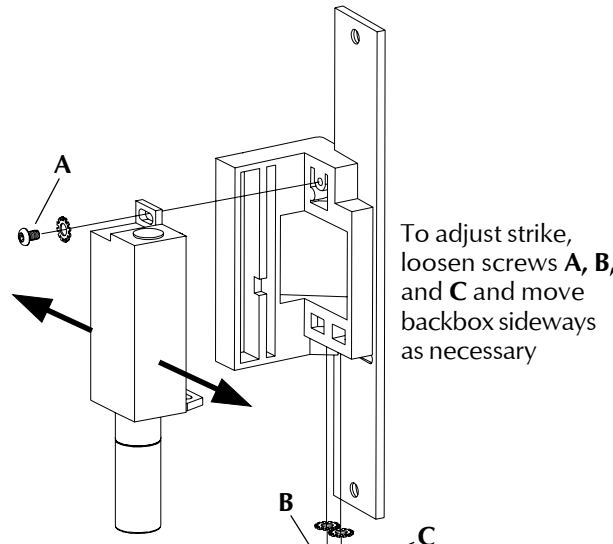

Figure 3

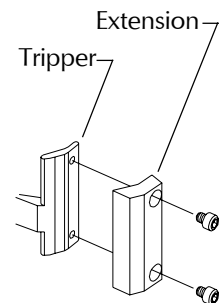
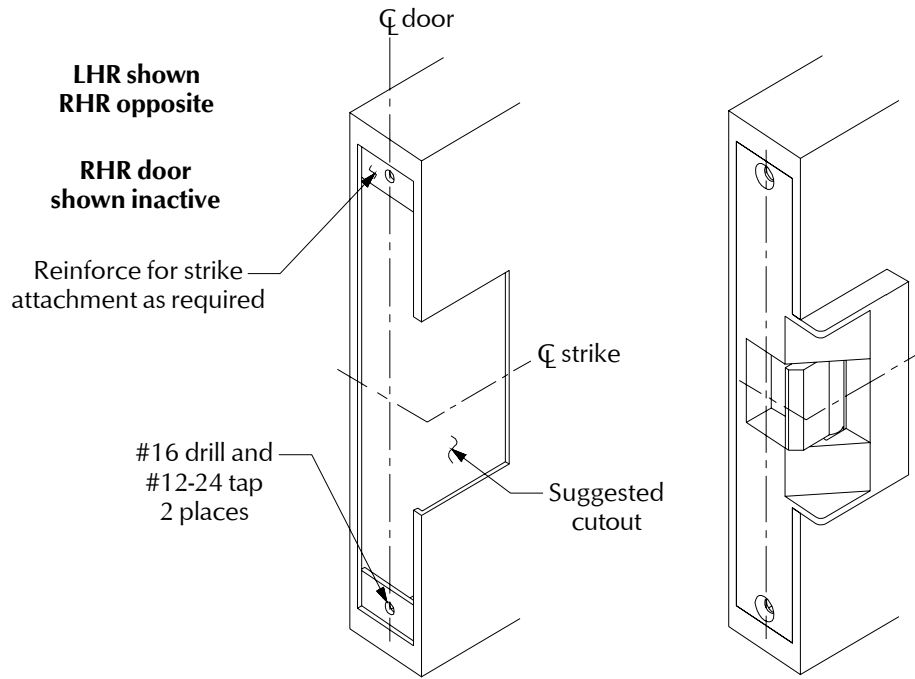
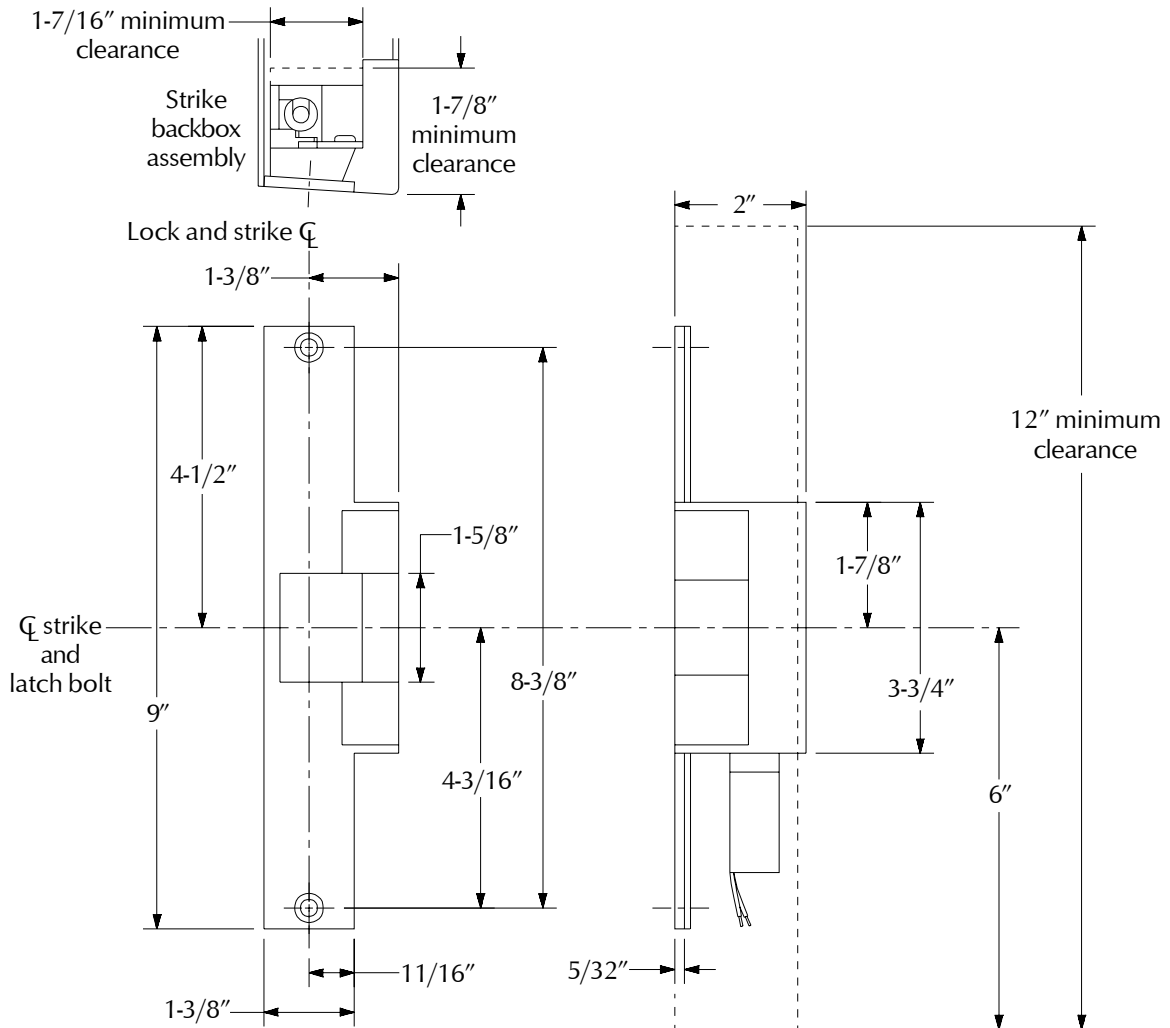

Figure 4



**Door Preparation for Strike**



**Strike Dimensions and Required Clearances**