

**Joni 16 Wall** LED T20

**DESCRIPTION**

Joni by Tech Lighting features a glowing integrated LED that sits against the backdrop of a simple elliptical reflector. A uniquely contemporary wall sconce, Joni is has heightened visual interest with color-on-color or two-tone finishes designed for both indoor and outdoor applications. Offered as matte black outer shade with a matte white inner reflector, all matte black and all aged brass (indoor-only). Three popular sizes make the Joni wall sconce great for any environment. Complete the look with the extended Joni family, by installing with the ceiling flush mount and pendant. Lamping options are compatible with most dimmers. Refer to the Dimming Chart for more information. Includes 120-277 volt universal 12.5 watt, 828 delivered lumens, 3000K LED module. Dimmable with most LED compatible ELV, TRIAC and 0-10V dimmers. Mounts vertically or horizontally.

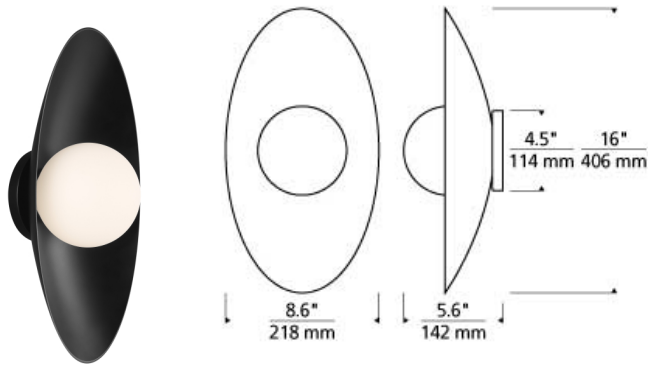

**INSTALLATION**

This product can mount to either a 4" square electrical box with round plaster ring or an octagonal electrical box (not included).

**WEIGHT**

2.0-2lb / 0.91-0.91kg ±

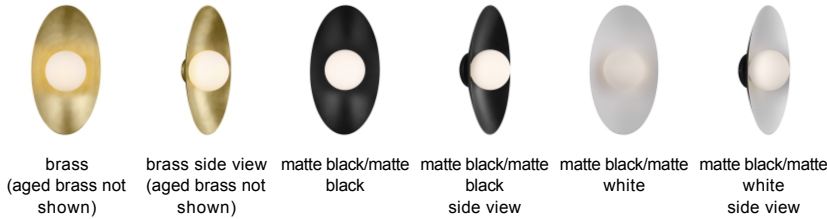

**ORDERING INFORMATION**

700WSJNI	LENGTH (A)	FINISH	LAMP
	16 16"	R AGED BRASS BB MATTE BLACK / MATTE BLACK BWMATTE BLACK / MATTE WHITE	-LED930 INTEGRATED LED 90 CRI 3000K 120V-277V UNV (T24)



**TECH LIGHTING®**  
 7400 Linder Avenue T 847.410.4400  
 Skokie, Illinois 60077 F 847.410.4500

**Tech Lighting, L.L.C.**

700WS JNI \_\_\_\_\_

FIXTURE TYPE: \_\_\_\_\_

JOB NAME: \_\_\_\_\_

NOTES: \_\_\_\_\_

\_\_\_\_\_

\_\_\_\_\_