

ASSEMBLY INSTRUCTIONS

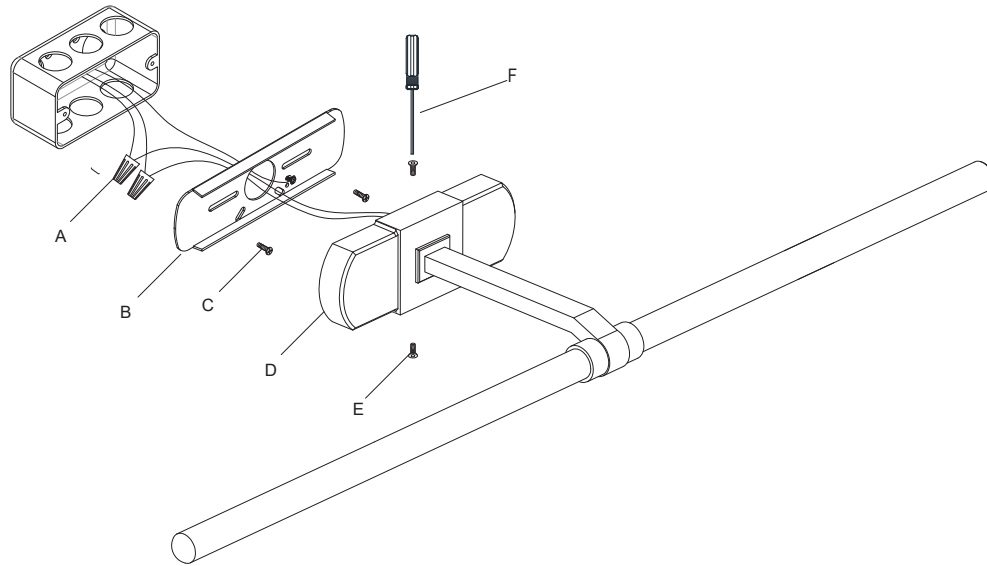

Langley 32" Picture Light

Item # RL 2782

NOTICE:

This light fixture should be installed in accordance with all applicable, local installation codes, and by a person familiar with the construction and operation of it, as well as the hazards involved. Inspect item and contents carefully. If any damage or defect is found, do not install. Retain all packaging material until installation is complete and approved.

1. Carefully remove all parts from the box.
2. Remove the mounting plate (B) from the fixture body (D) by loosening the set screws (E) using the set screwdriver (F).
3. Install the mounting plate (B) to the junction box and secure with the mounting screws (C).
4. Wrap the junction box ground wire to the green ground screw on the mounting plate (B) and secure.

IT IS IMPERATIVE THAT THIS FIXTURE BE GROUNDED.

5. Connect the fixture white wire to the neutral wire in the junction box using the wire nut (A).
6. Connect the fixture black wire to the hot wire in the junction box using the wire nut (A).

DO NOT REVERSE THE HOT AND NEUTRAL CONNECTIONS OTHERWISE SAFETY WILL BE COMPROMISED.

7. Install the fixture body (D) to the mounting plate (B) and secure with the set screws (E) by the set screwdriver (F).
8. Rotate the shade to desired angle.
9. Installation is complete, turn on power at fuse or circuit breaker.

Care Instructions: Clean only with a soft dry cloth or feather duster. Do not use abrasive or chemical agents.

RALPH LAUREN

