

CHC4392

ASSEMBLY & INSTALLATION GUIDE

WE RECOMMEND INSTALLATION OF THIS LIGHTING FIXTURE BE DONE BY A LICENSED ELECTRICIAN.

WARNING * SWITCH OFF THE MAIN ELECTRICAL SUPPLY FROM THE MAIN FUSE BOX/CIRCUIT BREAKER BEFORE INSTALLATION.**

INSPECT ITEM CAREFULLY BEFORE ATTEMPTING TO INSTALL. IF THERE IS ANY DAMAGE OR OBVIOUS DEFECT, DO NOT INSTALL.

ITEM MAY NOT BE RETURNED ONCE IT HAS BEEN INSTALLED.

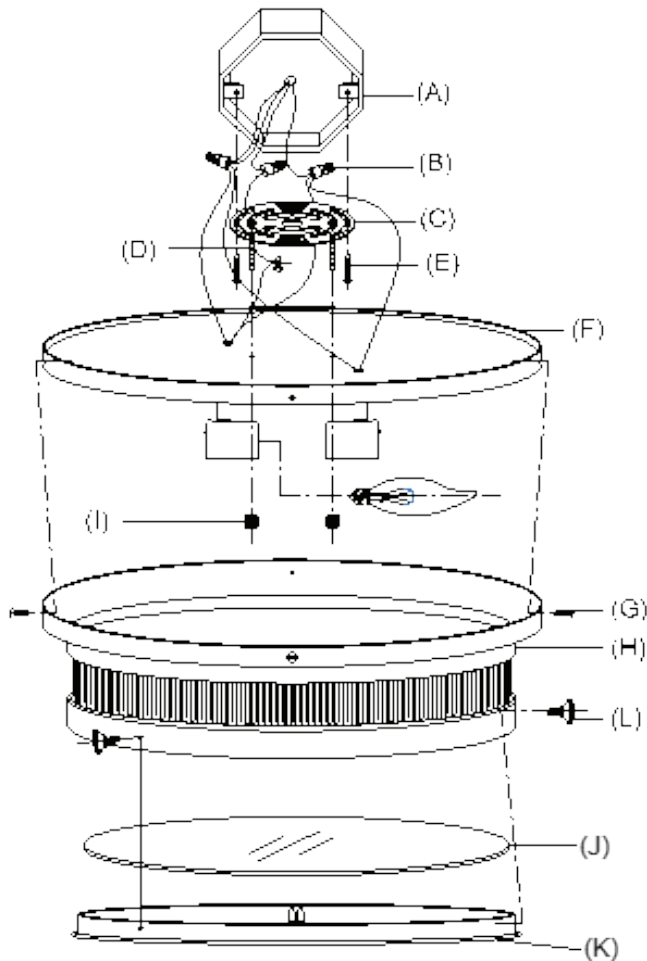

1. Carefully remove the canopy (F) from the fixture (H) by removing side screws (G).
2. Remove mounting plate (C) from canopy (F) by unscrewing ball nuts (I).
3. Affix mounting plate (C) onto ceiling outlet box (A) and secure with mounting screws (E).
4. Connect the hot wire from the fixture (BLACK) to the hot wire from ceiling outlet box (A) (usually BLACK). Fasten them together with a plastic wire connector (B) provided and wrap connection with electrical tape.
5. Repeat this procedure for the WHITE neutral wire from the light fixture to the wire from ceiling outlet box (A) (usually WHITE). Connect ground wire from the light fixture (GREEN or bare copper) to ground wire from ceiling outlet box (A) (usually green or copper in color).
6. Insert light bulbs (not included). To avoid the risk of fire, do not exceed the recommended wattage.
7. Attach the canopy (F) to affixed mounting plate (C), letting rods (D) on mounting plate (C) pass through the holes on the canopy (F), and secure with ball nuts (I).
8. Carefully remove the part (K) from the fixture (H) by removing thumb screws (L).
9. Attach glass (J) to part (K) by bending the glass tab to secure the glass panel.
10. Secure part (K) onto the fixture (H) by finial (L).
11. Secure the fixture (H) onto the canopy (F) by side screws (G).
12. Restore power to outlet box and test fixture.