

CHC2175

ASSEMBLY & INSTALLATION GUIDE

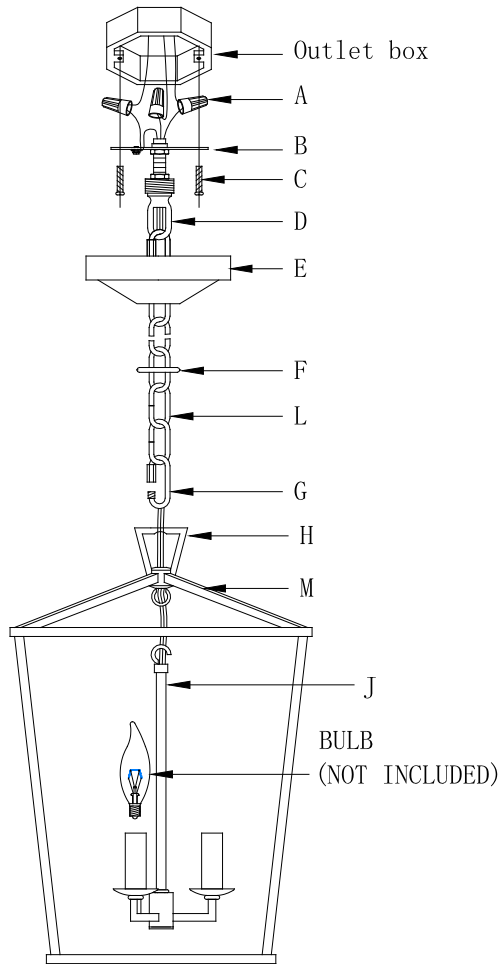

WE RECOMMEND INSTALLATION OF THIS LIGHTING FIXTURE BE DONE BY A LICENSED ELECTRICIAN.

WARNING * SWITCH OFF THE MAIN ELECTRICAL SUPPLY FROM THE MAIN FUSE BOX/CIRCUIT BREAKER BEFORE INSTALLATION.**

INSPECT ITEM CAREFULLY BEFORE ATTEMPTING TO INSTALL. IF THERE IS ANY DAMAGE OR OBVIOUS DEFECT, DO NOT INSTALL.

ITEM MAY NOT BE RETURNED ONCE IT HAS BEEN INSTALLED.

1. Carefully hook center tube (J) onto fixture body (M). Install the crossbar (B) with ceiling loop (D) to outlet box by using mounting screws (C) provided. Put canopy (E) to ceiling loop, and secure with lock collar (F).
2. Using the dimensions of the fixture as a guide, shorten the chain (L) as needed using a pair of chain pliers.
3. Take into consideration that you will use the chain end link to mount the chandelier once you have removed the excess chain.
4. Unscrew the threaded collar on the chain end link. Attach the chain to the ceiling loop (D). Close threaded collar to secure the chain.
5. Unscrew the threaded collar on the other chain end link. Raise the fixture and attach chain end link to the top ring (H). Close the threaded collar to secure the fixture body.
6. Unwrap the wiring from the top of the fixture body. Weave the power supply cord and the ground wire through the chain (L). When you reach the canopy and ceiling loop, measure the wires and cut. Be certain to leave enough to connect inside the canopy.
7. Strip the insulation back on the two power supply wires about 5/8".
8. Twist the power supply and ground wires together and push through the center hole in the ceiling loop.
9. Loosen the clock collar (F) and let the canopy (E) slip down the chain carefully.
10. **DO NOT REVERSE THE HOT AND NEUTRAL CONNECTIONS OR SAFETY WILL BE COMPROMISED.**
11. Connect the Ground (bare) fixture wire with the ground (usually bare) wire from ceiling box using wire nut (A). If your house does not have ground wire, then attach this wire to the green grounding screw inside of outlet box.
12. **IT IS IMPERATIVE THAT THE J-BOX IN YOUR HOME BE PROPERLY GROUNDED.**
13. Connect the Neutral fixture wire with the Neutral (usually white) wire from ceiling box using wire nut (A).
14. Connect the Hot (smooth edge, markings, or black) fixture wire with the Hot (usually black) wire from outlet box using wire nut (A).
15. Tuck these wire connections neatly into ceiling loop (D) to secure.
16. Put canopy (E) to ceiling loop, and secure with lock collar (F).
17. Install the light bulbs (not included) into sockets.
18. Installation is complete, turn on power at fuse or circuit breaker.