

W Series Wine Rack Frame 10

Installation guide for the standard W Series Frame 10 (FCF-HD)



3D INTERACTIVE INSTRUCTIONS

USE BILT® TO ASSEMBLE OR INSTALL WITH CONFIDENCE



Included:

- (2) 60" Frame Sections
- (2) Frame Couplers
- (36) Self-drilling screws

Additional Components:

(sold separately)

- W Series Wine Racks
- W Series Rack Couplers
- W Series Frame Backer Bar (single-sided displays)
- Mounting Hole Covers

Required Tools:

- Drill
- Phillips head drill bit
- Phillips head screwdriver
- Level
- Pencil or Marker
- Tape measure
- Metal cutting saw
- Metal file

Important Note:

These installation instructions will assist you with installing the VintageView W Series Frame System in standard floor-to-ceiling applications. If using upgraded mounting plates, refer to individual product install guides. The Frame System is designed for ceiling heights of up to 10' (3,048mm).

Fasteners:

Fasteners for securing W Series racking to the Frame is included, but hardware for floor or ceiling surfaces is not. When installing finished W Series Frame to the floor or ceiling, please use the following recommendations for fasteners:

Guidelines for Floor/Ceiling Hardware

Wood/Stud: #8 x 1-1/4" course thread screws (or longer)

Concrete, Brick, or Stucco: 3/16" x 1-1/4" masonry screw or #8 x 1-1/4" screw with appropriate size expanding anchor

Drywall: Expanding hollow wall anchors with at least #8 screw size



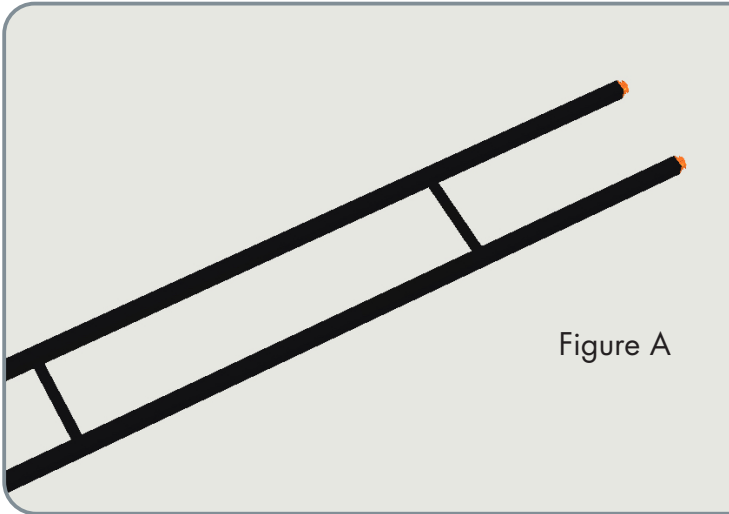

Figure A

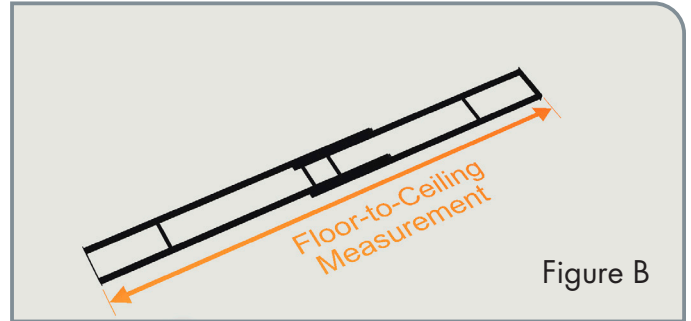

Figure B



Figure C

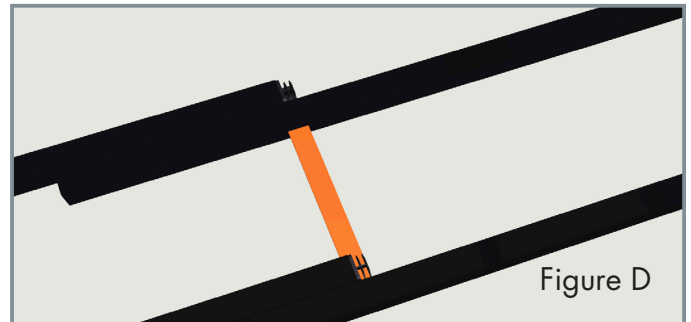

Figure D

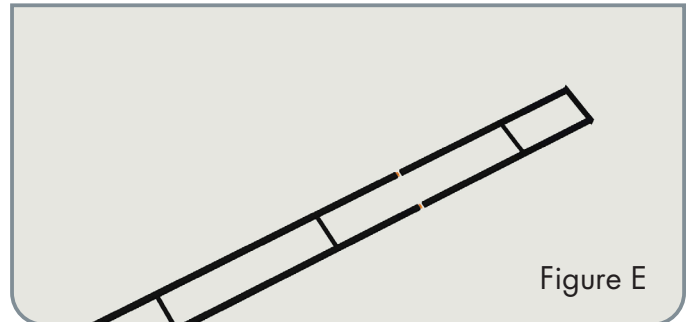

Figure E

1. IDENTIFY PROPER HARDWARE

Using the chart on the previous page, identify the proper floor/ceiling hardware (not included) that will be needed for your specific project. For drywall surfaces, VintageView recommends installing to joists or wood backing when available.

2. MEASURE CEILING HEIGHT

Measure the desired location's ceiling height.

3. INSERT FRAME COUPLERS

Insert two (2) Frame Couplers to the section of the Frame that will be used for the Bottom (Figure A).

4. MARK CUT LINES

Lay each section, interlaced, as shown above (Figure B). Position the Frame so that the measurement from top to bottom of the base plates equals your ceiling height.

Use a pencil or marker to mark any overlap on the bottom of the Post Top, which is the side that features a hollowed out opening. Ensure that the mark is at the widest part of the Coupler (Figure C).

If the cut mark aligns with a cross member, measure and cut 2in (51mm) off the bottom Section using a Metal Cutting Saw and start the step over (Figure D).

5. CUT THE FRAME

Using a Metal Cutting Saw, squarely cut the Frame Top at the mark. Smooth the end of the Frame with a Metal File.

Do not use abrasive saws as they may damage the finish.

6. CONNECT THE FRAME

Connect the top Section to the Bottom, ensuring the Couplers are firmly lodged into both ends of the Frame (Figure E).



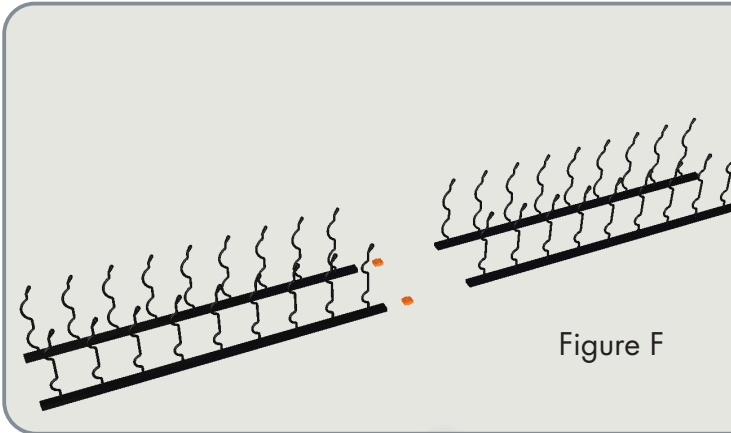

Figure F

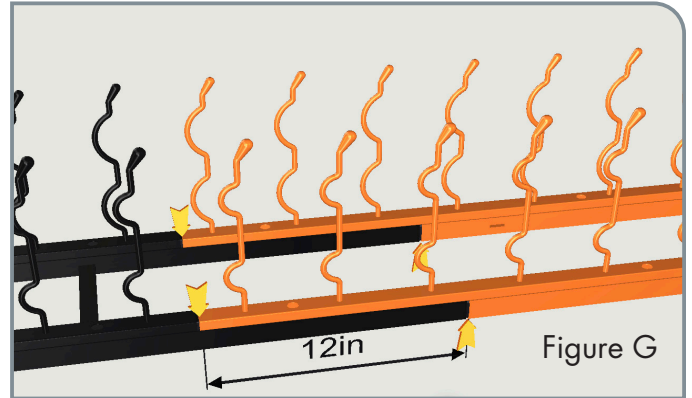

Figure G

7. MARK CEILING/ FLOOR MOUNTING HOLES

Place the Frame in desired location. Ensure it is plumb with a level and mark the mounting holes on both the ceiling and the floor. Set the Frame aside and pre-drill any required pilot holes based on hardware selection.

8. BUILD THE RACKS

It is common to use one (1), two (2), or (3) W Series Wine Racks on one or both sides of a W Series Frame. If using more than one, connect the W Series Wine Racking by removing the two (2) Endcaps from the end of each Wine Rack where they will connect.

Connect the Neck Strips (smaller bottle impressions) together with the supplied Wine Rack Couplers (Figure F). Repeat with the Base Strips (larger bottle impressions).

VintageView recommends leaving a minimum of 6in (153mm) above and below the W Series Racks when assembled to Frame.

9. PLACE THE RACKS

Lay the connected Strips in the desired location on the Frame, ensuring the Neck Strips are facing in preferred direction. **IMPORTANT:** One single Wine Rack Strip must extend 12in (305mm) above or below all connection points of the Frame (Figure G).

10. SECURE THE RACKS

Attach the Racking Assembly to the Frame using two (2) or three (3) Self Drilling Screws per Strip (quantity will vary based on individual height of racking).

Then press two (2) or three (3) Mounting Hole Covers into each Strip section (quantity will vary based on individual height of racking).

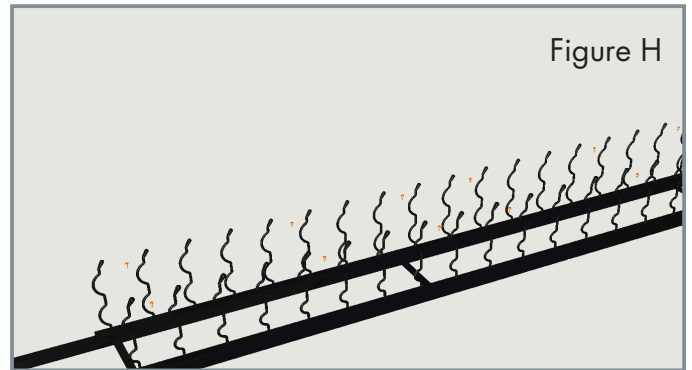

Figure H

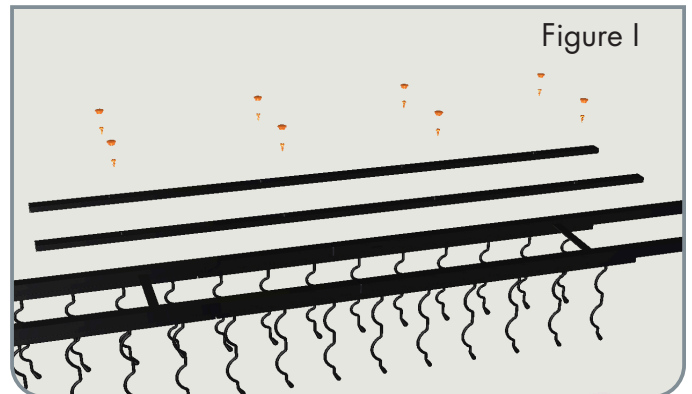

Figure I

11. SECURE THE BACK

All connection points on the backside of the Frame must be supported by either Wine Racking or a W Series Frame Backer Bar.

For Single Sided Displays

Use eight (8) Self-Drilling Screws to attach two (2) W Series Frame Backer Bars (FCF-BACK) to the back side of the Frame, centered over the two connection points. Then press eight (8) Mounting Hole Covers over the Screws.





Figure J

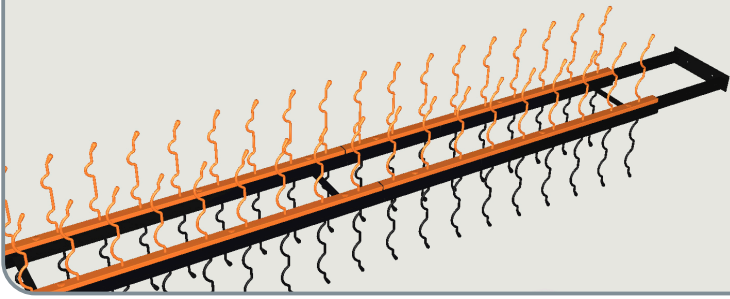

For Double-Sided Displays

Repeat Steps 8-10 to install Wine Racks to the back side of the Frame (Figure J).

IMPORTANT: The Backer Bar or Wine Racking must extend 12in (305mm) above or below all connection points of the Frame.

12. INSTALL THE SYSTEM

Stand the Frame Assembly in the desired location and ensure it is plumb both front and back and side-to-side with a level (Figure K).

Secure the Frame to the ceiling (Figure L) using two (2) of the appropriate fasteners (not provided). Double check the Frame is plumb and secure the Frame to the floor using two (2) of the appropriate fasteners (not provided).

13. ADD WINE

Only the good stuff.

Problems?

Try BILT 3D intelligent instructions, visit www.vintageview.com, or call 303-504-9463.

Maintenance and Care:

The W Series Frame should be regularly checked for tightness. Should any rack be found to be loose, tighten by hand until secure. All components of the W Series Frame System may be cleaned with a damp cloth and mild dish soap - abrasive pads or steel wool should NOT be used as they will damage the finished surfaces of the parts.

Figure K

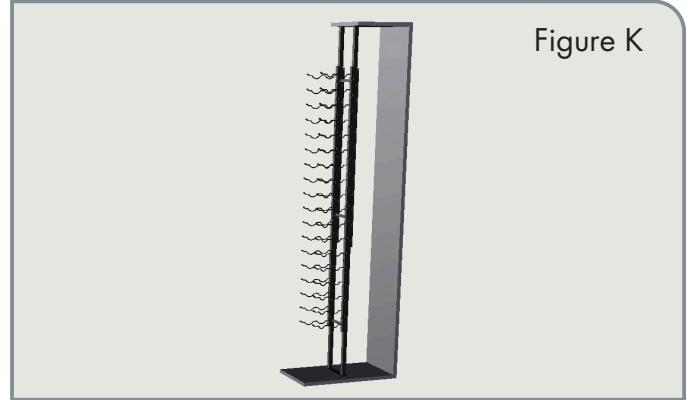

Figure L



SCAN FOR BILT. 3D INSTRUCTIONS



POWERED BY BILT INTELLIGENT INSTRUCTIONS®

