

# MODEL VG6047 ERIE



## INSTALLATION INSTRUCTIONS FOR STANDING SHOWER CABIN

PLEASE READ INSTRUCTIONS BEFORE PROCEEDING





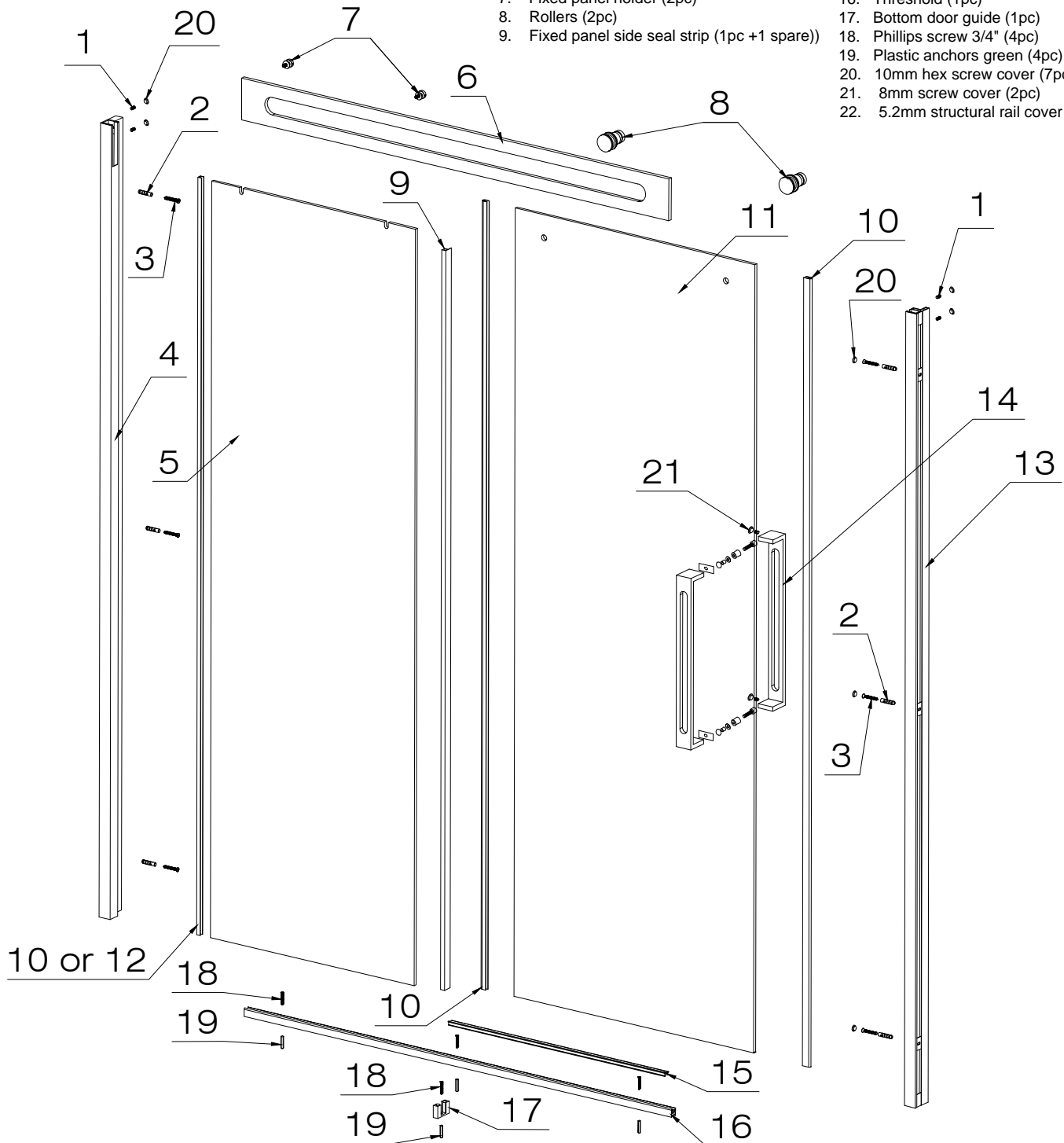







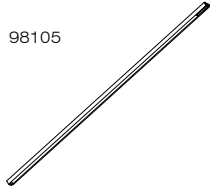

### Parts List

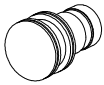
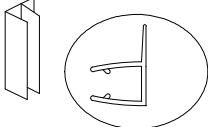
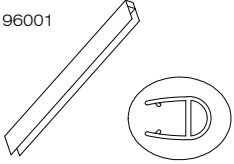
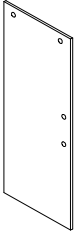
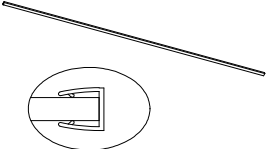
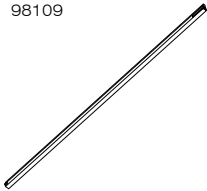
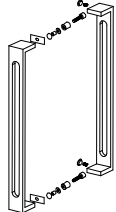
- |   |  |
|---|--|
| 1. Structural rail holders (4pc)                | 10. Door side seal strip (3pc + 1 spare)   |
| 2. Plastic anchors white (6pc)                  | 11. Door panel (1pc)                       |
| 3. Hex Screw 1 5/8" (6pc)                       | 12. Fixed panel wall side seal strip (1pc) |
| 4. Left vertical rail (1pc)                     | 13. Right vertical rail (1pc)              |
| 5. Fixed Panel (1pc)                            | 14. Handle assembly (1pc)                  |
| 6. Structural rail (1pc)                        | 15. Threshold extension clip (1pc)         |
| 7. Fixed panel holder (2pc)                     | 16. Threshold (1pc)                        |
| 8. Rollers (2pc)                                | 17. Bottom door guide (1pc)                |
| 9. Fixed panel side seal strip (1pc + 1 spare)) | 18. Phillips screw 3/4" (4pc)              |
|   | 19. Plastic anchors green (4pc)            |
|   | 20. 10mm hex screw cover (7pc)             |
|   | 21. 8mm screw cover (2pc)                  |
|   | 22. 5.2mm structural rail cover (2pc)      |



GLASS THICKNESS: 3/8"

NOTE: INSTALLATION MUST BE DONE BY A QUALIFIED, LICENSED PROFESSIONAL.

<p>1. STRUCTURAL RAIL HOLDERS</p> <p>98114</p> 	<p>2. PLASTIC ANCHORS WHITE</p> <p>98038</p> 	<p>3. HEX SCREW 1 5/8"</p> <p>98039</p> 	<p>4. LEFT VERTICAL RAIL</p> <p>98105</p> 	<p>5. FIXED PANEL</p> <p>97040</p> 
<p>6. STRUCTURAL RAIL</p> <p>98106</p> 	<p>7. FIXED PANEL HOLDER</p> <p>98107</p> 	<p>8. ROLLERS</p> <p>98108</p> 	<p>9. FIXED PANEL SIDE SEAL STRIP</p> <p>96013</p> 	<p>10. DOOR SIDE SEAL STRIP</p> <p>96001</p> 
<p>11. DOOR PANEL</p> <p>97039</p> 	<p>12. FIXED PANEL WALL SIDE SEAL STRIP</p> <p>96019</p> 	<p>13. RIGHT VERTICAL RAIL</p> <p>98109</p> 	<p>14. HANDLE ASSEMBLY</p> <p>98110</p> 	<p>15. THRESHOLD EXTENSION CLIP</p> <p>98112</p> 
<p>16. THRESHOLD</p> <p>98115</p> 	<p>17. BOTTOM DOOR GUIDE</p> <p>98113</p> 	<p>18. PHILLIPS SCREW 3/4"</p> <p>98033</p> 	<p>20. 10mm HEX SCREW COVER</p> <p>98135</p> 	<p>22. 5.2mm STRUCTURAL RAIL COVER</p> <p>98134</p> 
		<p>19. PLASTIC ANCHORS GREEN</p> <p>98037</p> 	<p>21. 8mm SCREW COVER</p> <p>98111</p> 	

\* - WITH HARDWARE AND WITHOUT SHOWER BASE (FULLY INSTALLED)

MODEL	DIMENSION "A" (DOOR)	DIMENSION "B" (FIXED PANEL)	DIMENSION "C" (WIDTH)	HEIGHT	DOOR OPENING WIDTH
VG6047XX6074	34 3/16" x 73 1/2"	26 1/4" x 71 1/8"	59 1/2 - 60 1/2"	73 1/2"	22 7/8" - 23 7/8"

A & B DIMENSIONS WERE MEASURED AFTER SHOWER ENCLOSURE WAS COMPLETELY INSTALLED

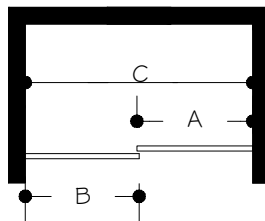

⊗ Product lines may change, contact your Vigo representative at 1-866-591-7792 or visit our website at [www.vigoindustries.com](http://www.vigoindustries.com) for the most up to date product line information.