

MODEL VG6082 POWELL

INSTALLATION INSTRUCTIONS FOR SHOWER DOOR

PLEASE READ INSTRUCTIONS BEFORE PROCEEDING





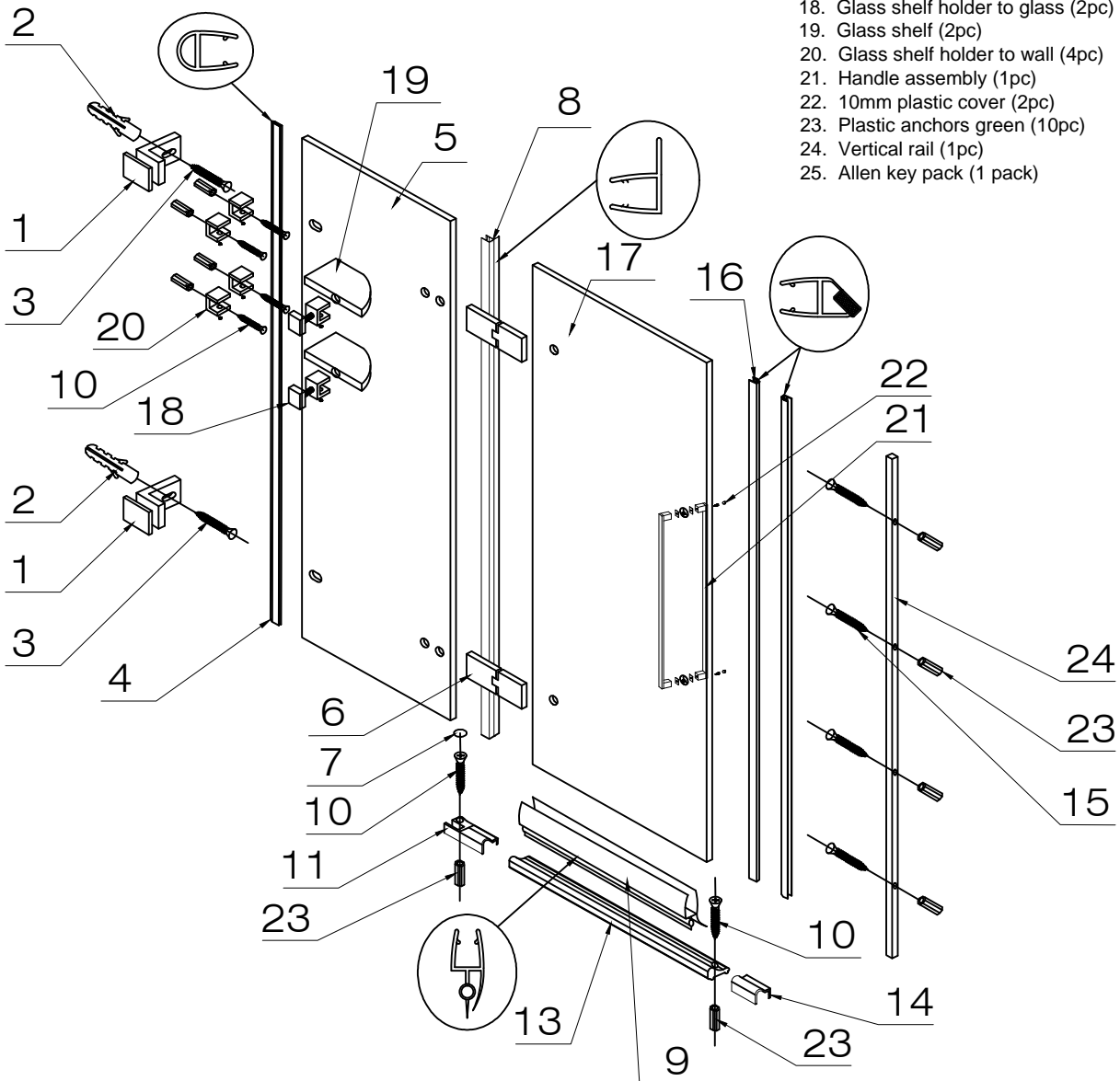





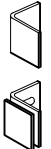
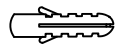

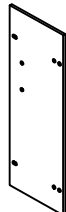
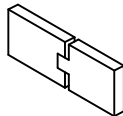

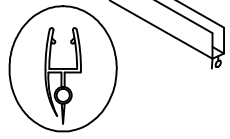
Parts List

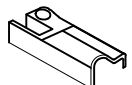
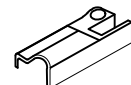
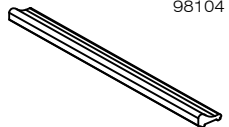
1. Glass support (2pc)
2. Plastic anchors white (2pc)
3. Hex screw 1 5/8" (2pc)
4. Side seal strip (1pc)
5. Fixed panel (1pc)
6. Hinges (2pc)
7. 8mm plastic cover (1pc)
8. Side seal strip with flange (1pc + 1pc spare)
9. Door bottom seal strip (1pc + 1pc spare)
10. Phillips screw 3/4" (6pc)
11. Left threshold clip (1pc)
12. Right threshold clip (1pc)
13. Threshold (1pc)
14. Threshold end cap (1pc)
15. Phillips screw 1 1/8" (4pc)
16. Magnetic seal strip (2pc)
17. Door (1pc)
18. Glass shelf holder to glass (2pc)
19. Glass shelf (2pc)
20. Glass shelf holder to wall (4pc)
21. Handle assembly (1pc)
22. 10mm plastic cover (2pc)
23. Plastic anchors green (10pc)
24. Vertical rail (1pc)
25. Allen key pack (1 pack)

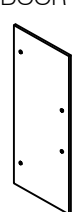
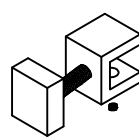
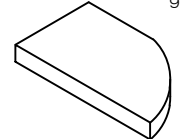
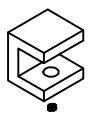
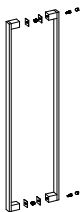

GLASS THICKNESS 8mm / 5/16"

NOTE: INSTALLATION MUST BE DONE BY A QUALIFIED, LICENSED PROFESSIONAL.

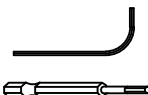
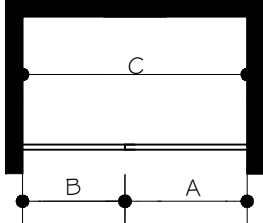
<p>1. GLASS SUPPORT</p>  <p>98095</p>	<p>2. PLASTIC ANCHOR WHITE</p>  <p>98038</p>	<p>3. HEX SCREW 1 5/8"</p>  <p>98039</p>	<p>4. SIDE SEAL STRIP</p>  <p>96043</p>	<p>5. FIXED PANEL</p>  <p>97048</p>
<p>6. HINGES</p>  <p>98146</p>	<p>7. 8mm PLASTIC COVER</p>  <p>98111</p>	<p>8. SIDE SEAL STRIP WITH FLANGE</p>  <p>96044</p>	<p>9. DOOR BOTTOM SEAL STRIP</p>  <p>96045</p>	<p>10. PHILLIPS SCREW 3/4"</p>  <p>98033</p>
<p>11. LEFT THRESHOLD CLIP</p>  <p>98057</p>	<p>12. RIGHT THRESHOLD CLIP</p>  <p>98058</p>	<p>13. THRESHOLD</p>  <p>98104</p>	<p>14. THRESHOLD END CAP</p>  <p>98150</p>	<p>15. PHILLIPS SCREW 1 1/8"</p>  <p>98136</p>
<p>16. MAGNETIC SEAL STRIP</p>  <p>96046</p>	<p>17. DOOR</p>  <p>97049</p>	<p>18. GLASS SHELF HOLDER (TO GLASS)</p>  <p>98147</p>	<p>19. GLASS SHELF</p>  <p>97026</p>	<p>20. GLASS SHELF HOLDER (TO WALL)</p>  <p>98148</p>
<p>21. HANDLE</p>  <p>98149</p>	<p>22. 10mm PLASTIC COVER</p>  <p>98135</p> <p>23. PLASTIC ANCHOR GREEN</p>  <p>98037</p>	<p>24. VERTICAL RAIL</p>  <p>98151</p>	<p>25. ALLEN KEY PACK</p>  <p>MISC</p>	

MODEL	DIMENSION "A" (DOOR)	DIMENSION "B" (FIXED PANEL)	DIMENSION "C" (WIDTH)	HEIGHT	DOOR OPENING WIDTH
VG6082XX4874	27 5/8" x 73"	21 3/4" x 74"	47 1/4" - 48 3/4"	74"	22 7/8" - 24 1/4"

A, B & C DIMENSIONS WERE MEASURED AFTER SHOWER DOOR WAS COMPLETELY INSTALLED