

**MODEL VG6081 ROCHELLE**

**INSTALLATION INSTRUCTIONS FOR SHOWER DOOR**

PLEASE READ INSTRUCTIONS BEFORE PROCEEDING





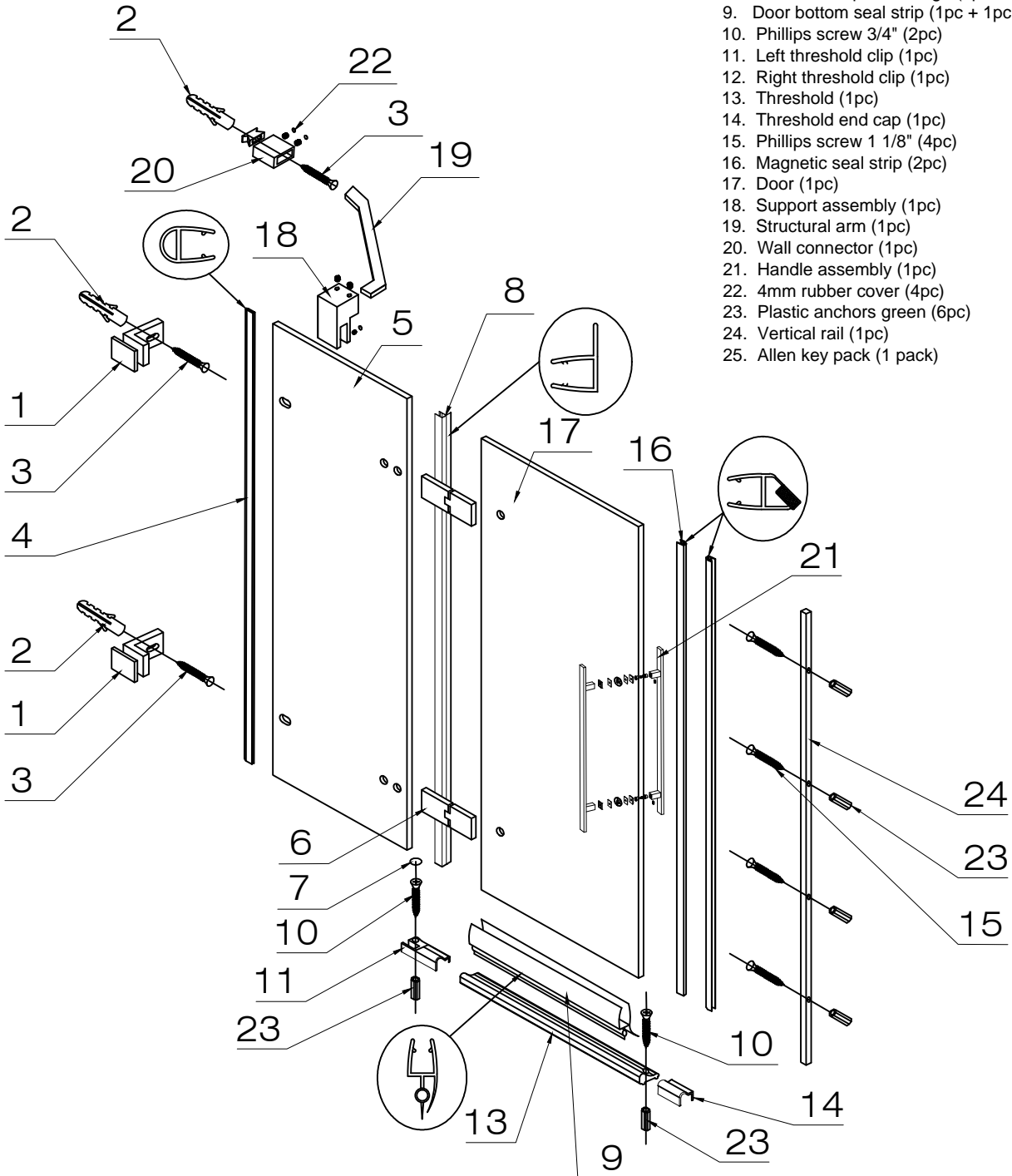





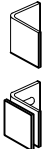
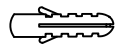

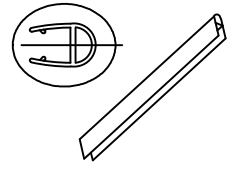

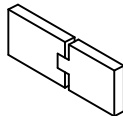

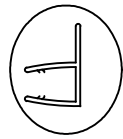
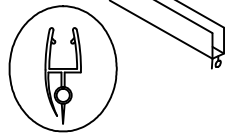
Parts List

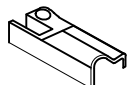
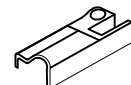
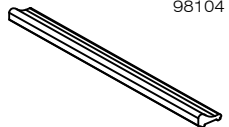
1. Glass support (2pc)
2. Plastic anchors white (3pc)
3. Hex screw 1 5/8" (3pc)
4. Side seal strip (1pc)
5. Fixed panel (1pc)
6. Hinges (2pc)
7. 8mm rubber cover (1pc)
8. Side seal strip with flange (1pc + 1pc spare)
9. Door bottom seal strip (1pc + 1pc spare)
10. Phillips screw 3/4" (2pc)
11. Left threshold clip (1pc)
12. Right threshold clip (1pc)
13. Threshold (1pc)
14. Threshold end cap (1pc)
15. Phillips screw 1 1/8" (4pc)
16. Magnetic seal strip (2pc)
17. Door (1pc)
18. Support assembly (1pc)
19. Structural arm (1pc)
20. Wall connector (1pc)
21. Handle assembly (1pc)
22. 4mm rubber cover (4pc)
23. Plastic anchors green (6pc)
24. Vertical rail (1pc)
25. Allen key pack (1 pack)

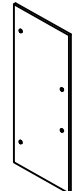
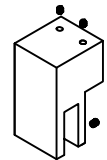
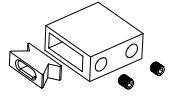
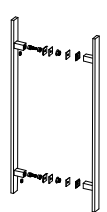

GLASS THICKNESS 8mm / 5/16"

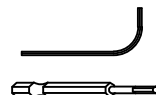
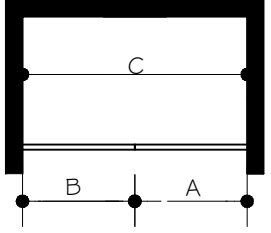
NOTE: INSTALLATION MUST BE DONE BY A QUALIFIED, LICENSED PROFESSIONAL.

<p>1. GLASS SUPPORT</p>  <p>98095</p>	<p>2. PLASTIC ANCHOR WHITE</p>  <p>98038</p>	<p>3. HEX SCREW 1 5/8"</p>  <p>98039</p>	<p>4. SIDE SEAL STRIP</p>  <p>96043</p>	<p>5. FIXED PANEL</p>  <p>97050CL21 97050CL33</p>
<p>6. HINGES</p>  <p>98146</p>	<p>7. 8mm RUBBER COVER</p>  <p>98111</p>	<p>8. SIDE SEAL STRIP WITH FLANGE</p>  <p>96044</p>	<p>9. DOOR BOTTOM SEAL STRIP</p>  <p>96045</p>	<p>10. PHILLIPS SCREW 3/4"</p>  <p>98033</p>
<p>11. LEFT THRESHOLD CLIP</p>  <p>98057</p>	<p>12. RIGHT THRESHOLD CLIP</p>  <p>98058</p>	<p>13. THRESHOLD</p>  <p>98104</p>	<p>14. THRESHOLD END CAP</p>  <p>98150</p>	<p>15. PHILLIPS SCREW 1 1/8"</p>  <p>98136</p>
<p>16. MAGNETIC SEAL STRIP</p>  <p>96046</p>	<p>17. DOOR</p>  <p>97049</p>	<p>18. SUPPORT ASSEMBLY</p>  <p>98153</p>	<p>19. STRUCTURAL ARM</p>  <p>98096</p>	<p>20. WALL CONNECTOR</p>  <p>98098</p>
<p>21. HANDLE</p>  <p>98152</p>	<p>22. 4mm RUBBER COVER</p>  <p>96040</p>	<p>24. VERTICAL RAIL</p>  <p>98151</p>	<p>25. ALLEN KEY PACK</p>  <p>MISC</p>	
<p>23. PLASTIC ANCHOR GREEN</p>  <p>98037</p>				

MODEL	DIMENSION "A" (DOOR)	DIMENSION "B" (FIXED PANEL)	DIMENSION "C" (WIDTH)	HEIGHT	DOOR OPENING WIDTH
VG6081XX4874	27 5/8" x 73"	21 3/4" x 74"	47 1/4" - 48 3/4"	74"	22 7/8" - 24 1/4"
VG6081XX6074	27 5/8" x 73"	33 3/4" x 74"	59 1/4" - 60 3/4"	74"	22 7/8" - 24 1/4"

A, B & C DIMENSIONS WERE MEASURED AFTER SHOWER DOOR WAS COMPLETELY INSTALLED