



Read and Save These Instructions
All Hoods Must Be Installed By A Qualified Installer

INSTALLATION INSTRUCTIONS

EUROLINE/EUROLINE PRO

WALL MOUNT HOOD

Read All Instructions Thoroughly Before Beginning Installation

WARNING - TO REDUCE THE RISK OF FIRE, ELECTRIC SHOCK, OR INJURY TO PERSONS, OBSERVE THE FOLLOWING:

- A. Installation work and electrical wiring must be done by qualified person(s) in accordance with all applicable codes and standards, including fire-rated construction. Switch power off at service panel and lock the service disconnecting means to prevent power from being switched on accidentally during installation.**
- B. When cutting or drilling into wall or ceiling, do not damage electrical wiring and other hidden utilities.**
- C. Ducted fans must always be vented to the outdoors.**
- D. Sufficient air is needed for proper combustion and exhausting of gases through the flue (chimney) of fuel burning equipment to prevent back drafting. Follow the heating equipment manufacturer's guideline and safety standards such as those published by the National Fire Protection Association (NFPA), and the American Society for Heating, Refrigeration and Air Conditioning Engineers (ASHRAE), and local code authorities.**

WARNING - TO REDUCE THE RISK OF FIRE, USE ONLY METAL DUCTWORK

Vent-A-Hood®

Ducting Do's and Don'ts

NEVER restrict the duct size. The single blower unit (B100) requires 6" round duct or equivalent (28 square inches), and the dual blower unit (B200) requires 8" round duct or equivalent (50 square inches). When combining ducts together, the square inch area must reflect the total square inch area of the ducts being combined. Using Vent-A-Hood transitions (back page) will ensure proper efficiency.

Blower	Duct Size	Sq. Inch Area	Vent-A-Hood Transition
Single (B100)	6" round or equivalent	28"	N/A
Dual (B200)	8" round or equivalent	50"	N/A
Single and Dual (B100 & B200)	10" round or equivalent	79"	VP562 (Included)
Two Dual (Two B200s)	12" round or equivalent	113"	VP563 (Included)

Do not use flexible or corrugated duct. This type of duct will restrict airflow and reduce performance. Only use smooth, galvanized, metal duct. Observe local codes regarding special duct requirements and placement of duct against combustibles. Make the duct run as short and as straight as possible with as few turns as possible. Avoid sharp-angled turns. Instead, use smooth, gradual turns such as adjustable elbows or 45 degree angled turns. For duct runs over 20 feet, increase the duct diameter by one inch for every ten feet of duct. A 90 degree elbow is equal to 5 feet of duct. Using Vent-A-Hood roof jacks or wall louvers (back page) will ensure proper efficiency. Airflow must not be restricted at the end of the duct run. Do not use screen wire or spring-loaded doors on wall louvers or roof jacks. Do not terminate venting into an attic or chimney. Where possible, seal joints with duct tape. The hood must be ducted to the outdoors without restrictions.

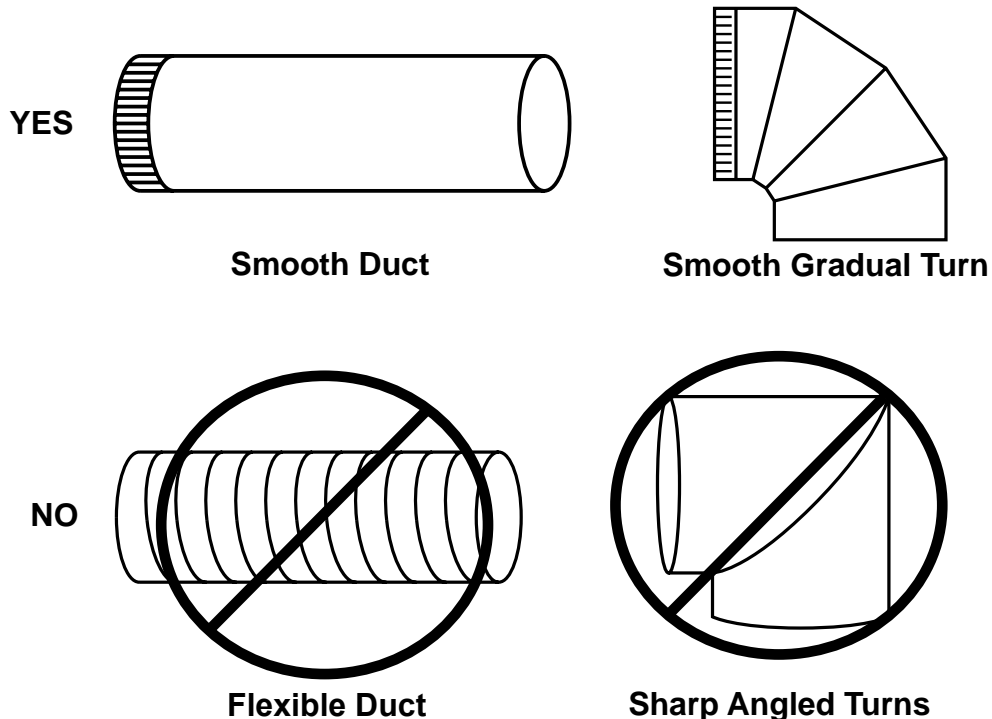

Vent-A-Hood®

Installation Details

- 1) Read all instructions thoroughly before beginning installation. Note: These instructions apply to standard hoods only. Custom hoods may require additional specification consideration.
- 2) When installing a 14" tall Euroline wall mount range hood, it is recommended that the bottom edge of the hood be located no more than 24" above the cooking surface. When installing an 18" tall Euroline Pro wall mount range hood, it is recommended that the bottom edge of the hood be located no more than 30" above the cooking surface. Exceeding the recommended maximum mounting height may compromise performance.

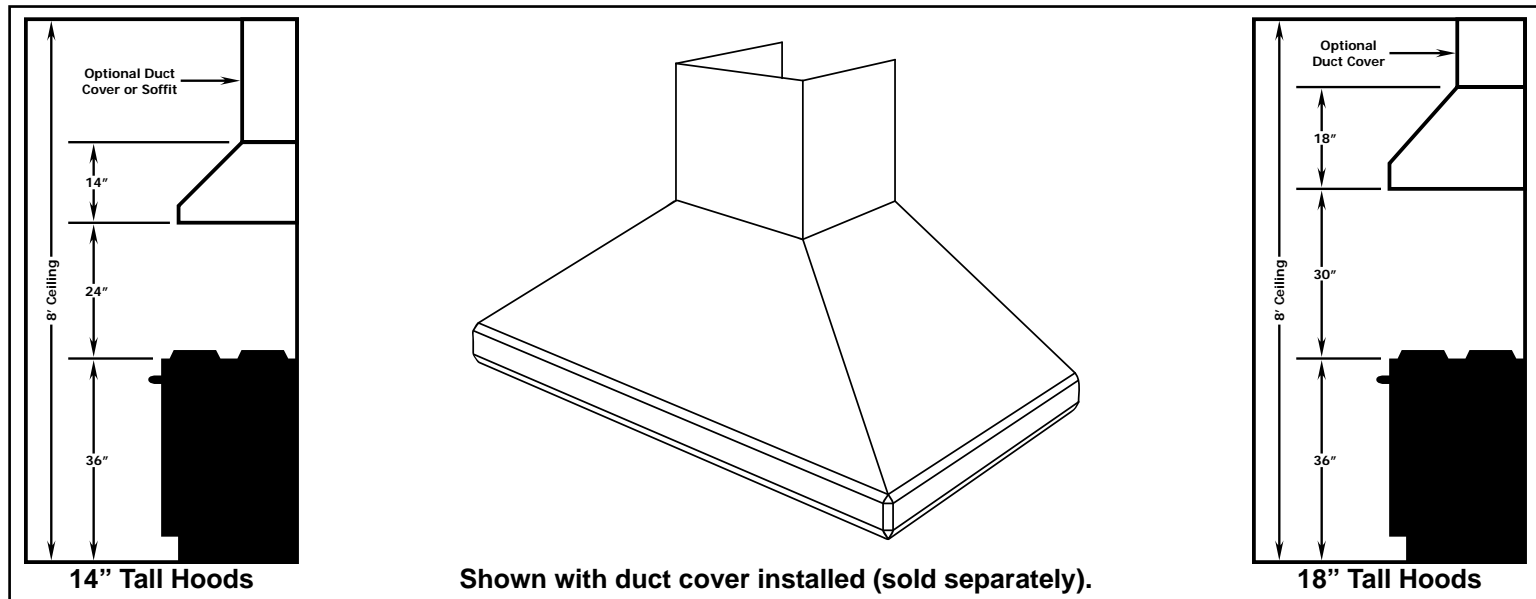

- 3) IF THE HOOD IS TO BE "BACK VENTED", PROCEED DIRECTLY TO STEP 4.

Install the duct from the outside of the home down to the location of the exhaust outlet on the top of the hood allowing room for the transition (if applicable). If a transition is used, install duct down to the location of the transition outlet plus 1". This will allow the transition to engage 1" inside of duct. Consult the connection diagrams (on next two pages) for further details on exhaust outlet placement.

Use duct tape to seal all joints. A complete listing of available Vent-A-Hood ducting materials is provided on the back page of this instruction sheet.

Transition heights are as follows:

Single Blower (B100):	6" round duct will connect directly to the top of the hood.
Dual Blower (B200):	8" round duct will connect directly to the top of the hood.
Single and Dual Blower (B100 & B200):	10" round combination transition (VP562, included) extends 8 1/2" above the top of the hood.
Two Dual Blowers (Two B200s):	12" round combination transition (VP563, included) extends 7 1/2" above the top of the hood.

- 4) Remove the hood from its packaging and place the back of the hood on the floor or countertop in front of the wall where it will hang.

Vent-A-Hood®

Installation Details Continued

14" Tall Euroline Connection Diagram (30" - 48" Widths)

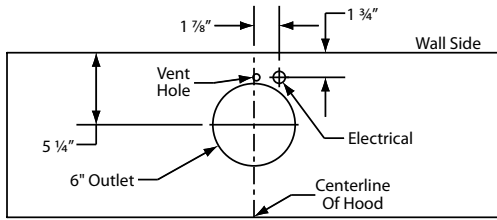

**300 CFM B100 Single Blower
(Top View)**

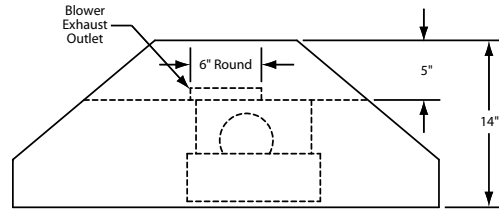

(Front View)

14" Tall Euroline Connection Diagram (36" - 48" Widths)

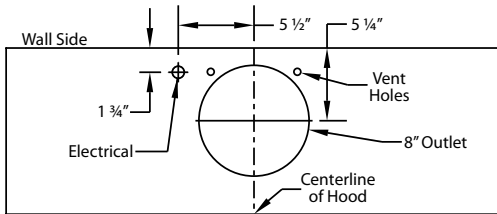

**600 CFM B200 Dual Blower
(Top View)**

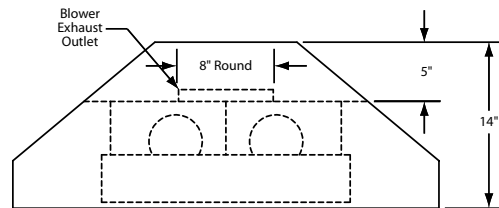

(Front View)

18" Tall Euroline Pro Connection Diagram (36" - 48" Widths)

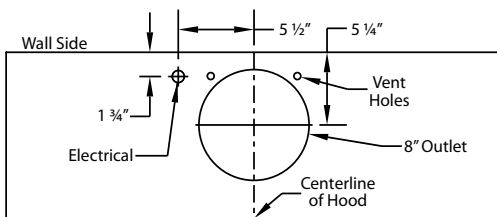

**600 CFM B200 Dual Blower
(Top View)**

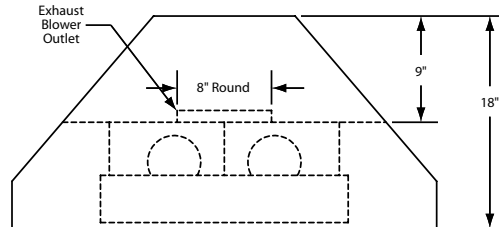

(Front View)

18" Tall Euroline Pro Connection Diagram (42" - 66" Widths)

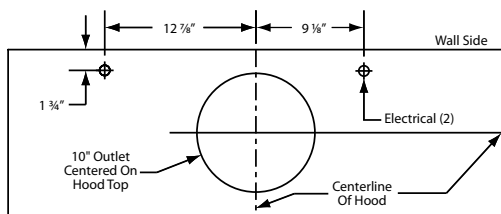

**900 CFM B200 Dual & B100 Single Blower
(Top View)**

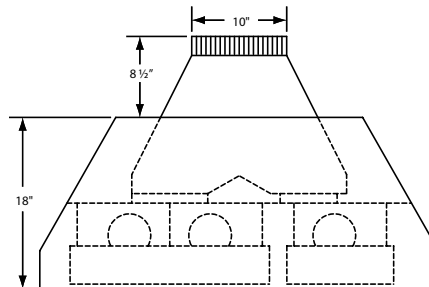

**VP562 Standard Transition
Installed (Front View)**

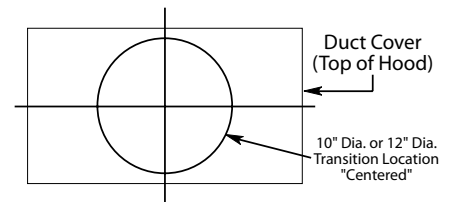

The transition shown (VP562) is installed in the hood at the factory as a standard item. It will be located in the exact center of the duct cover (left to right & front to rear).

See next page for 18" Tall Euroline Pro Connection Diagram for 54" - 66" widths.

Vent-A-Hood®

Installation Details Continued

18" Tall Euroline Pro Connection Diagram (54" - 66" Widths)

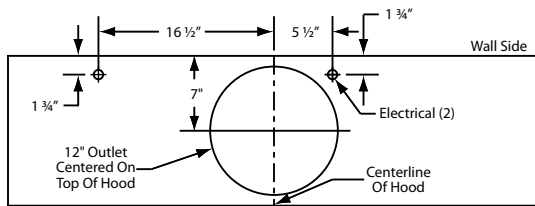

1200 CFM Double B200 Dual Blowers (Top View)

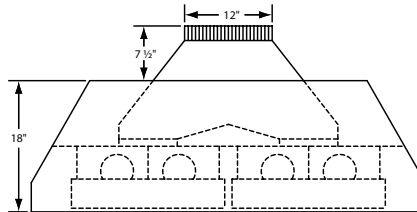

VP563 Standard Transition Installed (Front View)

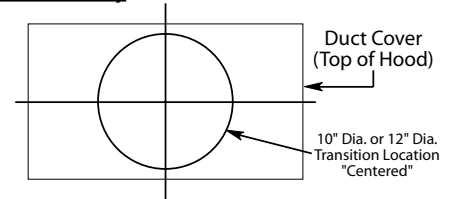

The transition shown (VP563) is installed in the hood at the factory as a standard item. It will be located in the exact center of the duct cover (left to right & front to rear).

- 5) Remove the blower shield(s) (A) by loosening the two brass screws on the bottom of the shield(s). Gently close the back draft damper(s) from the top side of the hood. To remove the blower housing(s), unsnap the suitcase latches (B) (one on each side of the housing). The housing(s) should be pulled forward and gently "tipped" to clear the blower wheel(s) and then out of the hood.

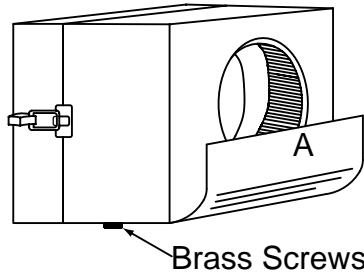

Brass Screws

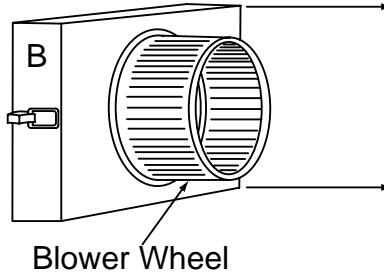

Blower Wheel

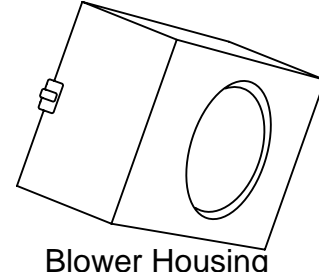

Blower Housing

- 6) Remove the three screws retaining the blower motor(s). Unplug and remove the motor(s), taking care not to damage the blower wheel(s). It is not necessary to remove the blower wheel from the motor.

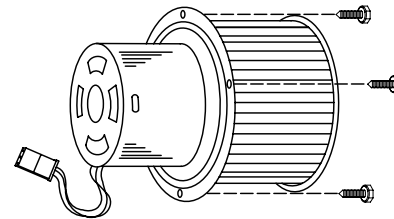

Warning: Make sure power is off and locked at the service disconnecting means on the service panel during installation.

- 7) Install an appropriate 1/2" UL listed electrical wire clamp through each motor box electrical opening on top of the hood. Install electrical wiring from the service panel to the hood location for each motor box. Consult the connection diagrams (above or on previous page) for further details on electrical placement. Extend wire(s) to the hood. Electrical connection(s) will occur before the hood is installed on the wall.

Model	Volts	Amps*	Hz	RPM	CFM SP@0.0"	Equivalent CFM*	CFM SP@0.1"	CFM SP@0.2"	CFM SP@0.3"	Minimum Round Duct Size	Sones#
B100 Single	115	1.5	60	1550	300	450	273	245	225	6" (28 in. ²)	5.4
B200 Dual	115	2.9	60	1550	600	900	531	480	430	8" (50 in. ²)	6.5
B200 Dual & B100 Single	115	4.4	60	1550	900	1350	804	725	655	10" (79 in. ²)	6.3
Two B200 Duals	115	5.8	60	1550	1200	1800	1062	960	860	12" (113 in. ²)	6.6

* Add 2.5 amps for each warming light and 0.5 amp for each halogen light.
 * Because the Magic Lung™ blower uses centrifugal filtration rather than conventional baffle or mesh filters, the Magic Lung™ blower can handle cooking equipment with higher cubic feet per minute (CFM) requirements and can deliver equivalent CFM much more efficiently than other filtration systems. When comparing the Magic Lung™ with other blower units made by other manufacturers, use the "Equivalent CFM".
 * Ratings in accordance with the Standard Test Code by the Energy Systems Laboratory of the Texas Engineering Experiment Station.

- 8) Remove the duct cover from its packaging and remove the mounting screws from the base of the duct cover. Place the duct cover on the top of the hood and secure it to the hood using the mounting screws previously removed. Lift the hood and duct cover assembly to the location on the wall where it will be installed and lightly mark the wall with a short, horizontal mark along the bottom edge of the hood.

- 9) Remove the hood and duct cover assembly from the wall. On the back side of the hood, measure the distance between the bottom edge of the hood and the top edge of the wood mounting strip. Measure this distance above the horizontal line made in Step 8 and lightly mark the wall with a level, horizontal line. Measure where the center (left to right) of the hood will be and mark the upper, horizontal line on the wall with a short, vertical centerline.



Installation Details Continued

10) Remove the screws inside the top of the back of the hood that retain the wood strip that is recessed in the mounting channel. **Note:** Some retaining screws may be located behind the blower(s). Remove the wood mounting strip from the back of the hood and place the top edge of the strip on the upper, level horizontal line on the wall. Referencing the vertical centerline from Step 9, place the mounting strip on the wall so it is centered (left to right) in the space where the hood will be located. Drill pilot holes in the strip to prevent splitting. Using proper hardware, attach the mounting strip to at least two wall studs.

11) **FOR BACK VENTING APPLICATIONS ONLY. IF NOT BACK VENTING, PROCEED DIRECTLY TO STEP 12.**

Note: Wall studs may interfere with back venting installations. Additional framing may be required. It is necessary to cut a duct access hole in the wall prior to installing the hood.

To accomplish this, first remove and set aside the duct cover that was previously installed in Step 8. Hold the hood on the mounting strip by aligning the channel at the top of the back of the hood over the wood mounting strip on the wall. Place the appropriate elbow on top of the hood in line with the hood exhaust collar. On the wall, trace around the elbow. Remove the hood and elbow from the wall. Cut around the outside of the traced line, avoiding wall studs. Install the duct from the outside of the home to the opening in the wall. Use duct tape to seal joints. Place the duct cover back onto the top of the hood and reattach it to the hood.

12) Hang the hood on the mounting strip by aligning the channel at the top of the back of the hood over the wood mounting strip on the wall. While holding the hood in place, mark locations on the mounting strip through the two mounting holes in the channel at the top of the hood. Some mounting holes may be located behind the blower(s). Remove hood and drill 3/32" pilot holes at the center of marks in the wood strip to prevent splitting.

13) **FOR BACK VENTING APPLICATIONS ONLY. IF NOT BACK VENTING, PROCEED DIRECTLY TO STEP 14.**

Place the appropriate elbow on the top of the hood. The elbow should be placed with the non-crimped end on the inside the collar of the exhaust outlet. Use duct tape to seal joint. Insert the electrical wire from the service panel into the electrical wire clamp on each motor box. Tighten the wire clamp(s). While securing the slack in the wire(s), lift the hood up to the wall and hang the hood on the mounting strip, taking care to properly align the duct connection between the elbow on the hood and the duct in wall. Secure the hood to the mounting strip by installing the screws (previously removed in Step 10) into the pilot holes drilled in Step 12. **SKIP STEPS 14 AND 15. PROCEED DIRECTLY TO STEP 16.**

14) Insert the electrical wire from the service panel into the electrical wire clamp on each motor box. Tighten the wire clamp(s). Cut a piece of duct of sufficient length to meet the duct in the ceiling allowing room for the transition (if applicable). If a transition is used, cut the duct to reach the transition outlet plus 1". This will allow the transition to engage 1" inside of the duct. See Page 3 for transition heights. One end of the duct must be crimped to fit inside the duct in the ceiling. Insert the non-crimped end over the transition or into the exhaust collar on the top of the hood and seal with duct tape.

15) While securing the slack in the wire(s), lift the hood up to the wall and hang the hood on the mounting strip, taking care to properly align the duct connection between the hood and the duct in the ceiling. Secure the hood to the mounting strip by installing the screws (previously removed in Step 10) into the pilot holes drilled in Step 12.

16) From inside the hood, using UL listed wire nuts, attach the "neutral" wire(s) to the white lead(s), the "hot" wire(s) to the black lead(s), and the ground wire(s) to the green lead(s) inside the motor box(es).

Warning: Do not operate hood without proper ground connection.

17) Plug the motor(s) into the hood and reinstall the blower motor(s) using the three retaining screws that were previously removed in Step 6.

18) Replace the blower housing(s) and the blower shield(s). Make sure that the damper(s) open and close smoothly.

19) Refer to the Owner Maintenance Guide Operating Instructions for proper hood operation. Test all blower and light functions to ensure they are operating properly.

VENTING



ACCESSORIES

WALL LOUVER

MODEL	DIM
VP526	6" Round
VP527	7" Round
VP528	8" Round

WALL LOUVER

MODEL	DIM
VP554	10" Round

WALL LOUVER

MODEL	DIM
VP555	12" Round

RECTANGULAR WALL LOUVER

MODEL	DIM
VP538	6" x 8 1/2"
VP560	3 1/4" x 10"

LOW PROFILE ROOF JACK (MAXIMUM 4/12 PITCH)

MODEL	DIM
VP539	6" Round
VP540	7" Round
VP541	8" Round

LOW PROFILE ROOF JACK (MAXIMUM 4/12 PITCH)

MODEL	DIM
VP552	10" Round
VP553	12" Round

ADJUSTABLE ELBOW

VP513 - 8 1/2"
VP514 - 9 3/16"
VP515 - 10 3/8"

MODEL	DIM
VP513	6" Round
VP514	7" Round
VP515	8" Round

BACK/SIDE VENT ELBOW

MODEL	DIM
VP561	8" to 6" x 8 1/2"

3 1/4" x 10" BACK VENT ELBOW

MODEL	DIM
VP559	3 1/4" x 10"

MULTI-BLOWER TRANSITION

VP562 - 17 1/2"
VP563 - 16 1/2"
VP562 - 23 1/4"
VP563 - 30 1/4"

MODEL	DIM
VP562	6" & 8" to 10"
VP563	8" & 8" to 12"

"Y" TRANSITION

MODEL	DIM
VP517	8" & 8" to 12"
VP518	6" & 8" to 12"
VP551	6" & 8" to 10"

3 1/4" x 10" TO 7" TRANSITION

MODEL	DIM
VP521	3 1/4" x 10" to 7"

OFFSET KIT - ROUND

MODEL	DIM
VP529	6" Rnd to 7" Rnd

OFFSET KIT - RECTANGULAR

MODEL	DIM
VP550	6" Rnd to 3 1/4" x 10"

STANDARD ISLAND TRANSITION

MODEL	DIM
VP565	5" x 16" to 8"

CLUSTER BLOWER TRANSITION

MODEL	DIM
VP564	8" & 8" to 12"

OFFSET L & R TRANSITION FOR ISLAND BLOWERS

MODEL	DIM
VP542	Top Left
VP543	Top Right

SIDE VENT TRANSITION L & R FOR ISLAND BLOWERS

MODEL	DIM
VP544	Left Side
VP545	Right Side

6" & 8" COLLAR

MODEL	DIM
VP533	6" Round
VP535	8" Round

6" x 8 1/2" COLLAR

MODEL	DIM
VP537	6" x 8 1/2"

ROUND DUCT PIPE

MODEL	DIM
VP500	6" Round
VP501	7" Round
VP502	8" Round

3 1/4" RECTANGULAR DUCT PIPE

MODEL	DIM
VP504	3 1/4" x 10"
VP505	3 1/4" x 12"
VP506	3 1/4" x 16"

6" RECTANGULAR DUCT PIPE

MODEL	DIM
VP507	6" x 8 1/2"