

PRH6-K36

Halogen lights. This model is not available with heat lamps. This model is available in black, biscuit, gunsmoke, stainless steel, and white. No customizations.

Dimensional Information

Width	36.0
Depth	19.5
Height	6.0
CFM @ 0.0" SP	250.0
Sones	7.4
Amps	3.2
# Lights	2.0

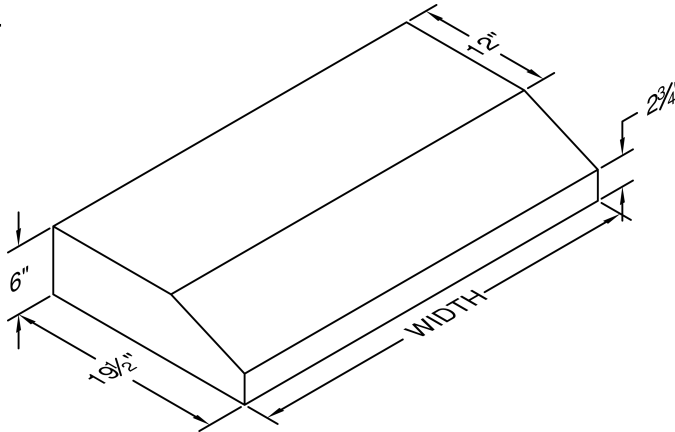

The VP521 transition is available for top vent applications at an additional charge.

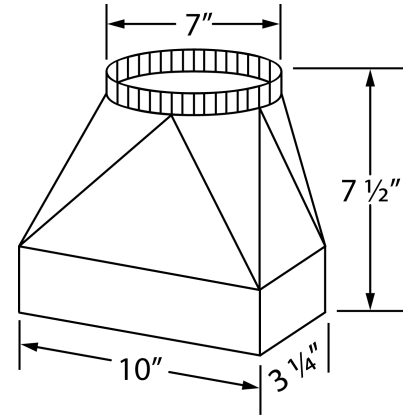

Connection Diagram

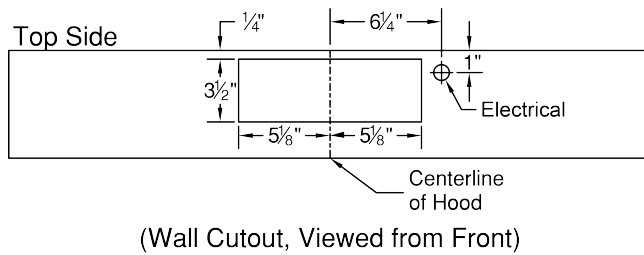
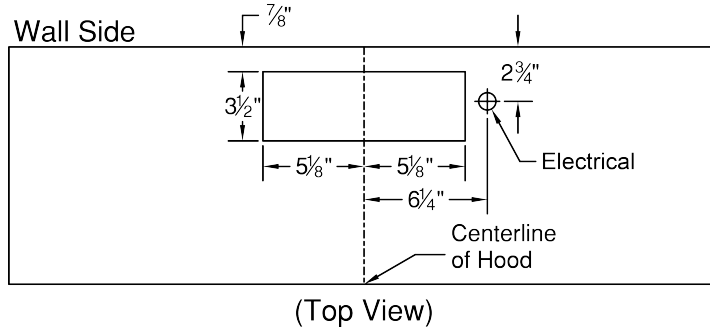

Recommended Mounting Height*

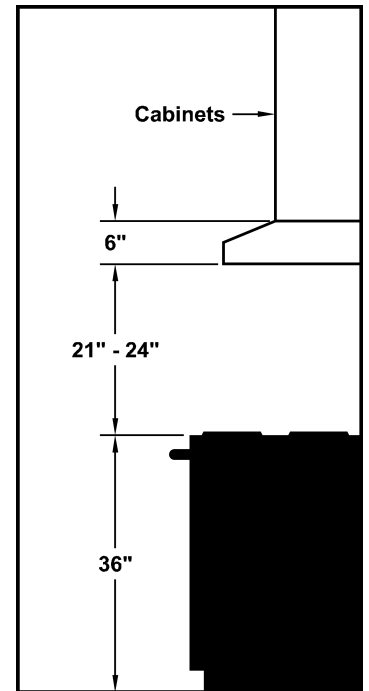

*Exceeding recommended mounting height may compromise performance.

Electrical/Mechanical Specifications For Blower Unit

Model	Volts	Amps*	Hz	RPM	CFM SP@0.0"	Equivalent CFM	CFM SP@0.1"	CFM SP@0.2"	CFM SP@0.3"	Minimum Round Duct Size	Sones#
K250 (Top Vent)	115.0	2.2	60.0	1550.0	250.0	360.0	223.0	220.0	190.0	7" (38 sq. in.)	7.4

\$ Because the Magic Lung® blower uses centrifugal filtration rather than conventional baffle or mesh filters, the Magic Lung® blower can handle cooking equipment with higher cubic feet per minute (CFM) requirements and can deliver equivalent CFM much more efficiently than other filtration systems. When comparing the Magic Lung® with other blower units made by other manufacturers, use the "Equivalent CFM".

Ratings in accordance with the Standard Test Code by the Energy Systems Laboratory of the Texas Engineering Experiment Station.