

ASSEMBLY AND INSTALLATION INSTRUCTIONS

P0341 / P0342

WARNING: TO AVOID RISK OF ELECTRICAL SHOCK, BE SURE TO SHUT OFF POWER WHILE INSTALLING OR SERVICING THIS FIXTURE.

NOTES: 1. Before installing, consult local electrical codes for wiring and grounding requirements.
2. READ AND SAVE THESE INSTRUCTIONS.

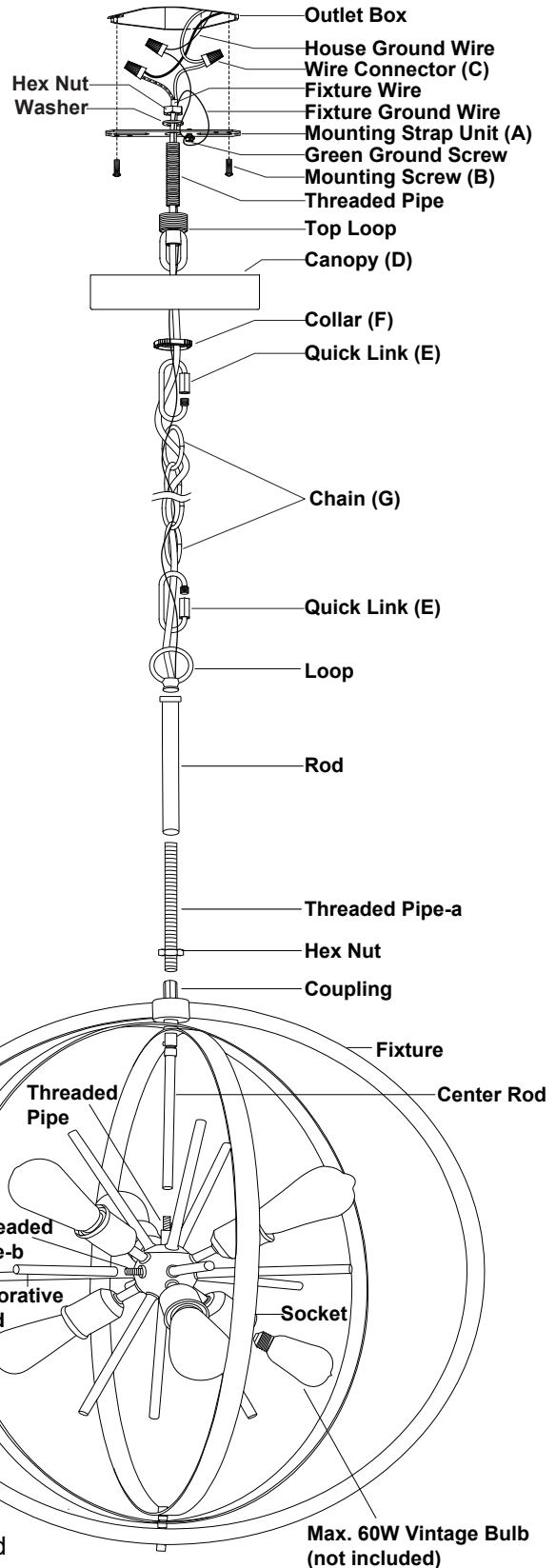
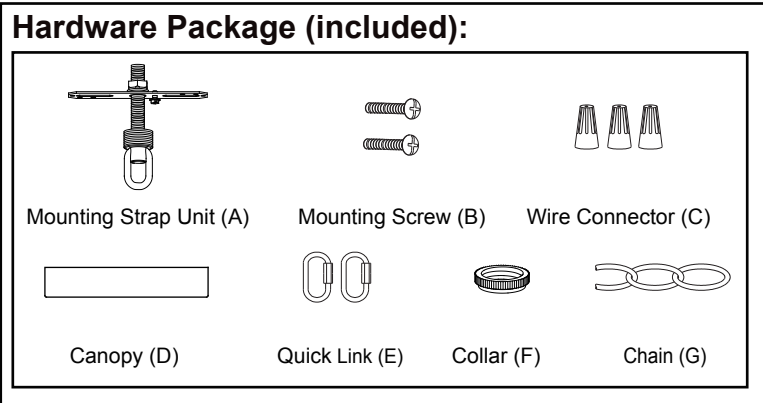

Installation Steps

Turn off the power at fuse or circuit box.

1. Lock the threaded pipe-a on the coupling and fix it with a hex nut.
2. Use rod passes through the threaded pipe-a and fix it with loop.
3. Secure the center rod onto fixture using the threaded pipe.
4. Screw 12 decorative rods to the other threaded pipes-b of fixture.
5. Attach the mounting strap unit (A) to the outlet box by using two mounting screws (B).
6. Choose the length of the chain (G) you need, then weave the fixture wire and the fixture ground wire through the chain (G), collar (F) and canopy (D).
7. Connect the chain (G) to the loop and the top loop on mounting strap unit (A) with two quick links (E).
8. Thread the fixture wire and fixture ground wire through the top loop, threaded pipe of the mounting strap unit (A).
9. Pull out the source wires from the outlet box. Make wire connections using wire connectors (C) as follows:
 - Connect the smooth-coated wire (marked) from the fixture to the black wire from the power source.
 - Connect the ribbed-coated wire (unmarked) from the fixture to the white wire from the power source.
 - Attach the fixture ground wire to the mounting strap unit (A) with the green ground screw, then connect it to the house ground wire with a wire connector (C).
 Carefully put the wires back into the outlet box.

VAXCEL







10. Attach the canopy (D) to the mounting strap unit (A) by inserting the top loop, then tighten the collar (F) to secure it.

11. Install 6 x 60W Max. vintage bulbs (not included). See relamping label at socket area or packaging for maximum wattage allowed.

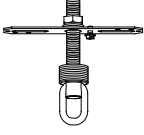
Turn on the power at fuse or circuit box.

The following parts are available for reorder if damaged or missing.

Spare Parts List:

 Mounting Strap Unit (A)	 Mounting Screw (B)	 Wire Connector (C)	→ Mounting Hardware 6285MM (1SET)
 Canopy (D)	 Quick Link (E)	 Collar (F)	
			 Chain (G) 3251CN

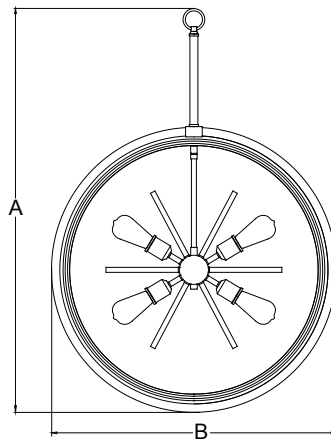

A: 38"
B: 26-3/4"

1 Year Warranty

Vaxcel warrants all of our products against defects in workmanship and finishes for one year following the date of shipment.

Exclusions: This warranty does not include the failure of products from extreme acts of nature; environmental conditions not suited for the products intended use; operation in temperatures outside of the range specified in the instruction manual; usage with improper power supply, power surges or dips. For coastal locations, some corrosion is considered normal for the environment.

Vaxcel reserves the right to repair, replace or issue a credit for any properly installed product, provided it is returned per RMA instruction. This warranty is limited to the cost of the product only and does not extend to transportation, installation or replacement costs.

How can warranty service be obtained?

info@vaxcel.com
1-800-482-9235