

# ASSEMBLY AND INSTALLATION INSTRUCTIONS

T0668

**WARNING: Turn off the main power at circuit breaker before installing fixture.**  
**AVERTISSEMENT: Coupez la source d'alimentation principale au panneau central de disjoncteurs avant d'installer le luminaire.**

**NOTE: 1. Before installing, consult local electrical codes for wiring and grounding requirements.**  
**2. READ AND SAVE THESE INSTRUCTIONS.**

## Hardware Package (included):



Mounting Plate Unit (A)

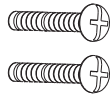

Mounting Screw (B)

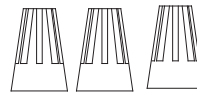

Wire Connector (C)



Set Screw (D)

## Installation Steps

Turn off the power at fuse or circuit box.

1. Unscrew the two set screws (D) to separate the mounting plate unit (A) from the fixture.

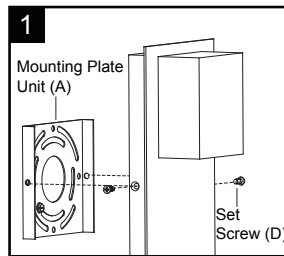

2. Attach the mounting plate unit (A) to the outlet box by using two mounting screws (B). **Note: Make sure that two set holes are lined up horizontally to make the fixture level.**

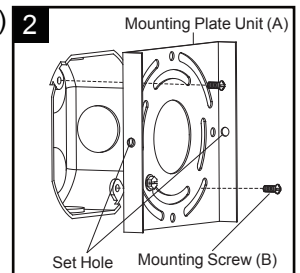

3. Pull out the source wires from the outlet box. Make wire connections using wire connectors (C) as follows:

- Connect the hot wire (usually black insulation) from the fixture to the black wire from the power source.
  - Connect the neutral wire (usually white insulation) from the fixture to the white wire from the power source.
  - Attach the fixture ground wire (usually green insulation or bare wire) to the mounting plate (A) with the green ground screw. Then, depending on local code, connect it to the house ground wire with the wire connector (C).
- Carefully put all of the wires back into the outlet box.

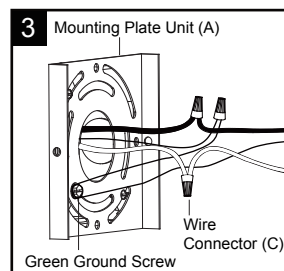

4. Loosen the fixture mounting screws from the fixture.

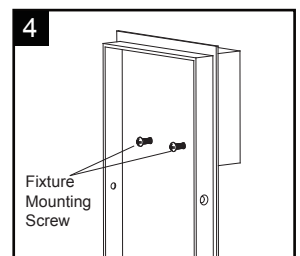

5. Put the solid glass panel into the fixture, then tighten the fixture mounting screws into the holes of solid glass panel.

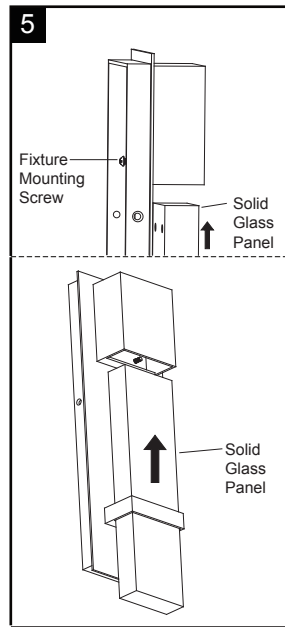

6. Attach the backplate of the fixture to the mounting plate unit (A) and then secure it with the two set screws (D).

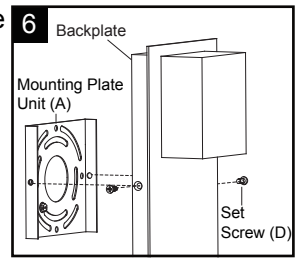

**Note: With silicone caulking compound, caulk completely around where the backplate meets with the wall surface to prevent water from seeping into the outlet box.**

Turn on the power at fuse or circuit box.

**Note: Only general ON/OFF wall switch applies for this fixture, the dimmable wall switch shouldn't be required.**

The following parts are available for re-order if damaged or missing.

Spare Parts List:

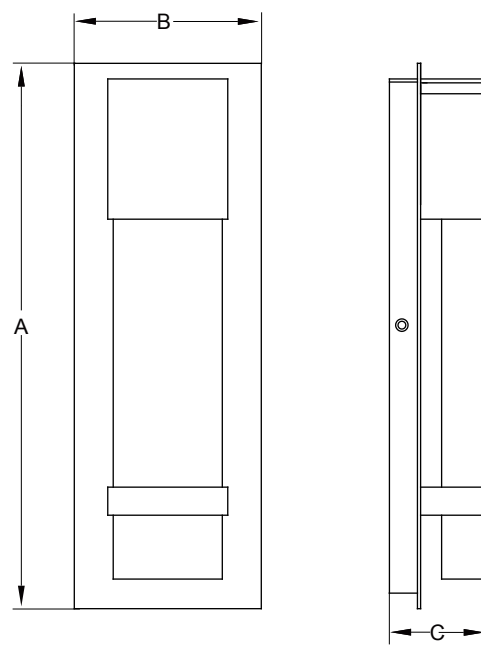
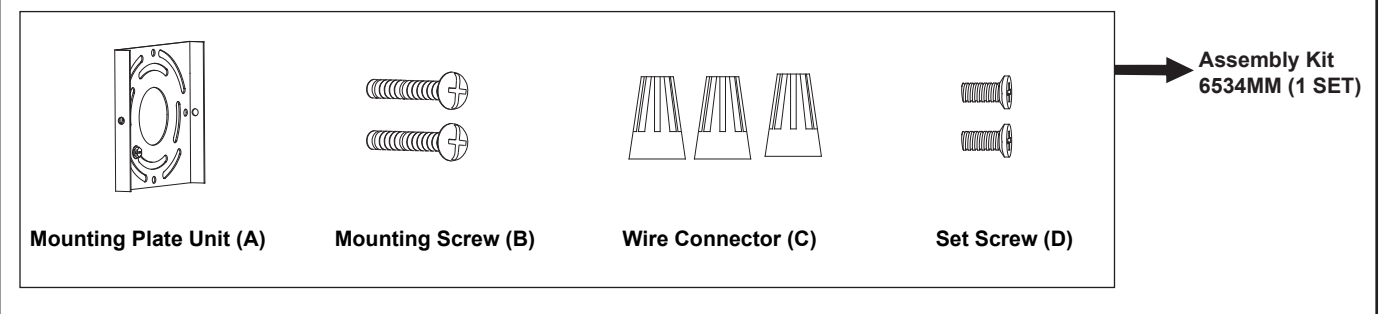

**A: 13-3/4"**

**B: 4-3/4"**

**C: 2-1/2"**