

ASSEMBLY AND INSTALLATION INSTRUCTIONS

P0277 P0279

WARNING: TO AVOID RISK OF ELECTRICAL SHOCK, BE SURE TO SHUT OFF POWER WHILE INSTALLING OR SERVICING THIS FIXTURE.

NOTES: 1. Before installing, consult local electrical codes for wiring and grounding requirements.
2. READ AND SAVE THIS INSTRUCTION.

Hardware Package (included):

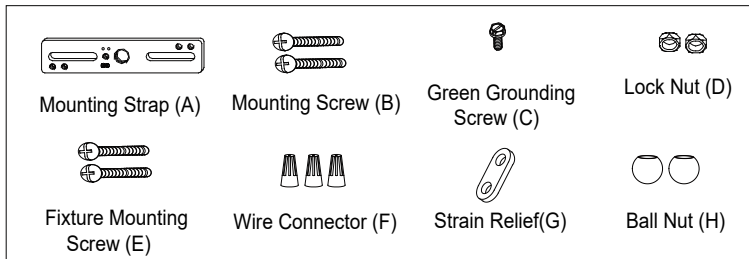

Installation Steps

Turn off the power at fuse or circuit box.

1. Unscrew two ball nuts, remove mounting strap from canopy.
2. Loosen the plastic headless screw on the canopy by using a flathead screw driver (not included).
3. Thread the cord through the canopy and strain relief. Measure the desired length of the cord (A) from the canopy to the glass shade and leave additional 9" cord (B) above the canopy (include the canopy), and then cut off the unnecessary cord. (See Fig.1)
4. Adjust strain relief at 9" position from the top of the cord.
5. Mark the 3" cord (C) from the top of the cord (B). Use a knife to peel off the insulation of the cord (C) carefully to show the 3 inside wires out. (See Fig. 1)
Caution : Cutting too deep may cut off three inside wires and destroy the insulation surface of the three inside wires.
6. Peel off the 3 wires from the top about 3/8" long (D) to expose the copper for wiring.
7. Attach the mounting strap to outlet box by using two mounting screws.
8. Pull out the source wires from the outlet box. Make wire connections using wire connectors as follows:
 - a. The black wire marked "L" from the fixture to the black wire from the power source.
 - b. The white wire marked "N" from the fixture to the white wire from the power source.
 - c. The green grounding wire marked "⊕" from the fixture to the green grounding wire from power source.
 Carefully put wires back into the outlet box.
9. Pull the cord (A) down slightly until the strain relief touches the hex nut. Attach the canopy to the mounting strap by inserting two fixture mounting screws, and then secure it with two ball nuts.

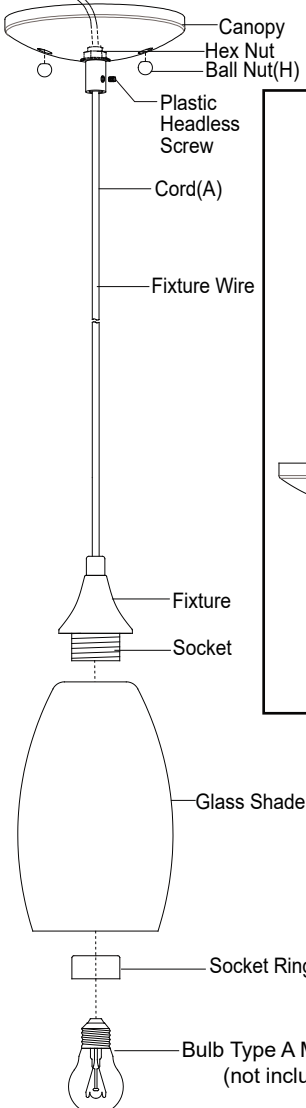
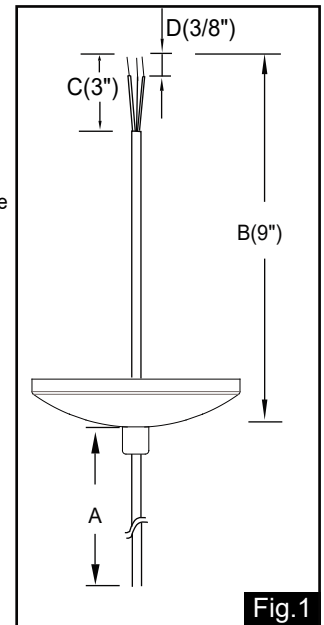
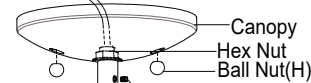
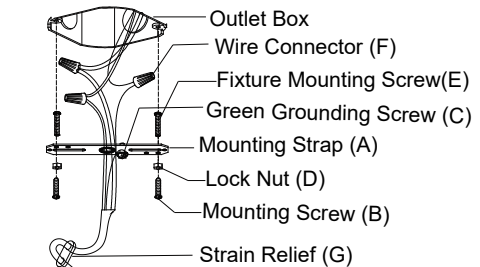









10. Fastening cord by screwing plastic headless screw, using flat head screwdriver (not included).
11. Attach the glass shade to fixture, and then secure it with the socket ring.
12. Install a bulb (not included). Check relamping label at socket area or packaging for maximum allowed wattage.

Turn on the power at fuse or circuit box.

The following parts are available for re-order if damaged or missing.

Spare Parts List:

 Mounting Strap (A)	 Mounting Screw (B)	 Green Grounding Screw (C)	 Lock Nut (D)
 Fixture Mounting Screw (E)	 Wire Connector (F)	 Strain Relief (G)	 Ball Nut (H)

Assembly Kit 5508MM (1 SET)

Glass Shade
9759AG (1 PC) for P0277
9760AG (1 PC) for P0279

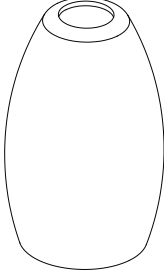
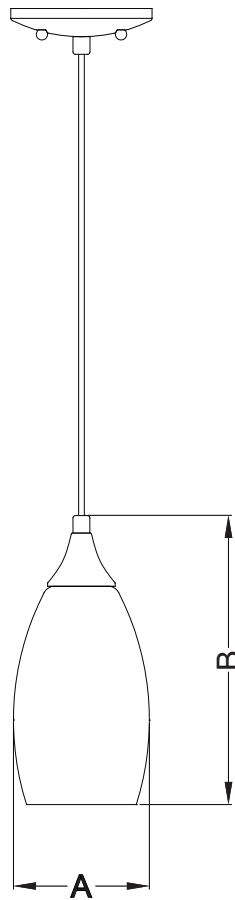
A: 4-3/4"

B: 9-3/4"