

ASSEMBLY AND INSTALLATION INSTRUCTIONS

T0351 / T0495

WARNING: Turn off the main power at circuit breaker before installing fixture.
AVERTISSEMENT: Coupez la source d'alimentation principale au panneau central de disjoncteurs avant d'installer le luminaire.

NOTE: 1. Before installing, consult local electrical codes for wiring and grounding requirements.
 2. Read and save these instructions.

Hardware Package (included):

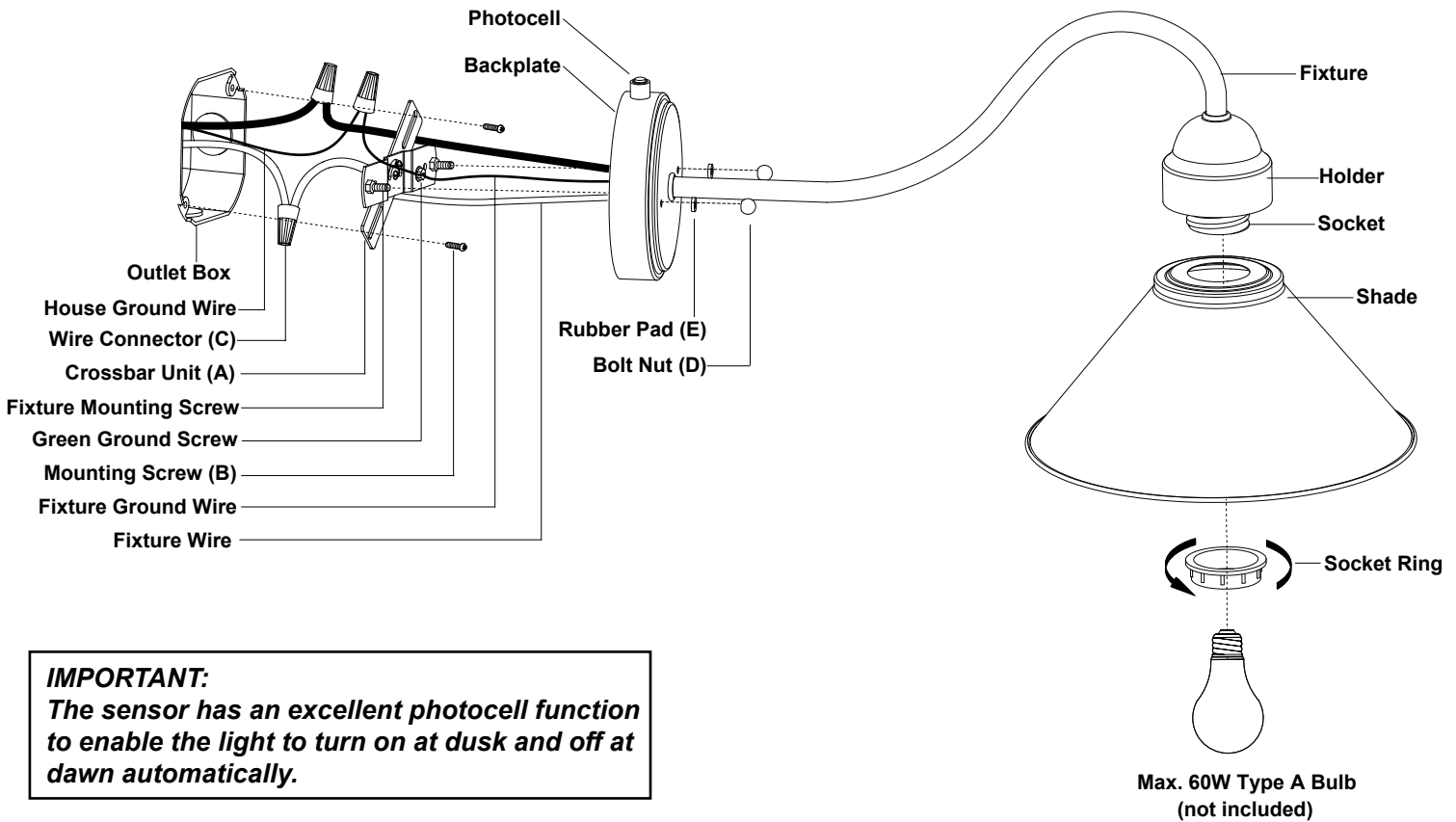
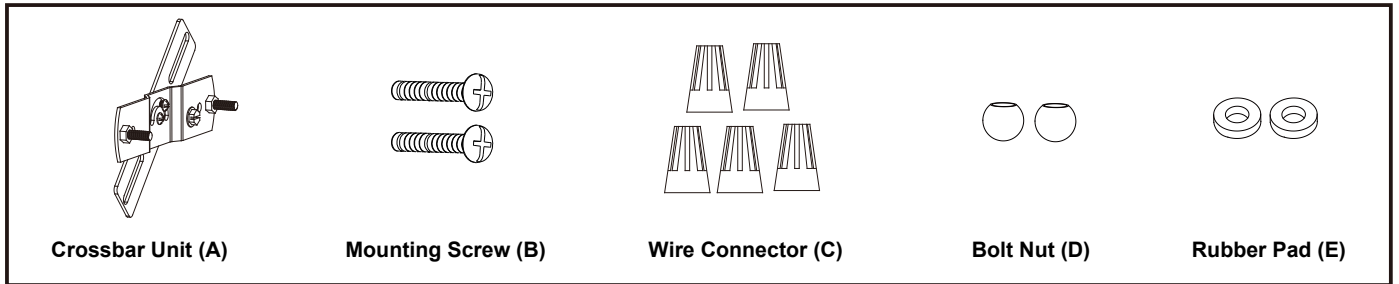

Installation Steps

Turn off the power at fuse or circuit box

1. Attach the crossbar unit (A) to the outlet box by using two mounting screws (B). Adjust the length of the preinstalled fixture mounting screws if necessary.

Note: Make sure that the fixture mounting screws are lined up horizontally to make the fixture level.

2. Pull out the source wires from the outlet box. Make wire connections using wire connectors (C) as follows:

- Connect the hot wire (black insulation) from the fixture to the black wire from the power source.
- Connect the neutral wire (white insulation) from the fixture to the white wire from the power source.
- Attach the fixture ground wire (bare wire) to the crossbar unit (A) with green ground screw. Then, depending on local code, connect it to the house ground wire with the wire connector (C).

Carefully put all of the wires back into the outlet box.

3. Attach the backplate of the fixture to the crossbar unit (A) by inserting fixture mounting screws into open holes on the backplate, then secure it with two rubber pads (E) and two bolt nuts (D).

Note: With silicone caulk compound, caulk completely around where the backplate meets with the wall surface to prevent water from seeping into the outlet box.

4. Attach the shade to the socket, and then secure it with the socket ring.

5. Install the bulb (not included). See relamping label at socket area or packaging for maximum wattage allowed.

Turn on the power at fuse or circuit box

Optional Installation: Disconnect Dusk-to-Dawn Photocell

IMPORTANT:

Compatible with dimmer when photocell is disconnected.

* Requires dimmable bulb and compatible dimmer switch.

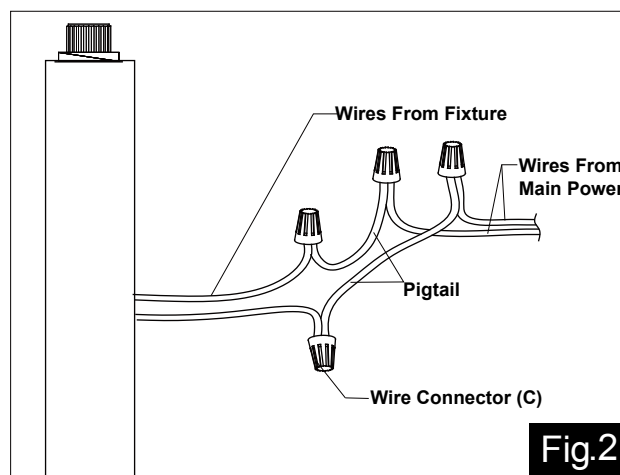
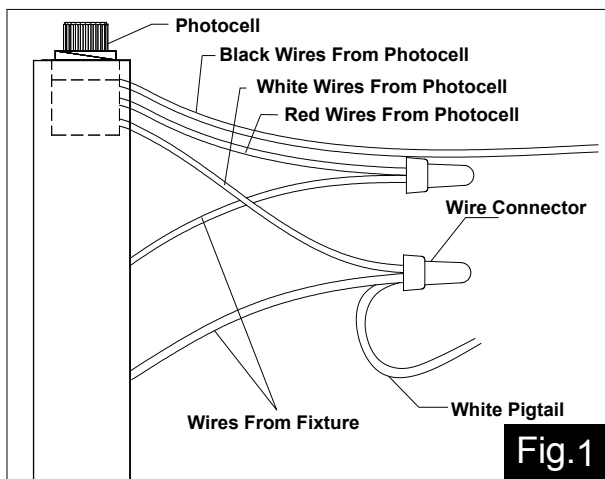

1. Turn off the power at the fuse or circuit box before starting installation.

2. Loosen the wire connectors connected with the wires from photocell. (See Fig.1)

Note: Do not remove the photocell to prevent water from seeping into the outlet box.

3. Take a white pigtail and black pigtail and make wire connections using wire connectors (C): (See Fig.2)

- a. The black wire from the fixture to one end of the black pigtail.
- b. The white wire from the fixture to one end of the white pigtail.
- c. The other end of the black pigtail to the black wire from the power source.
- d. The other end of the white pigtail to the white wire from the power source.

Put all wires back into the backplate of the fixture.

The following parts are available for reorder if damaged or missing.

Spare Parts List:

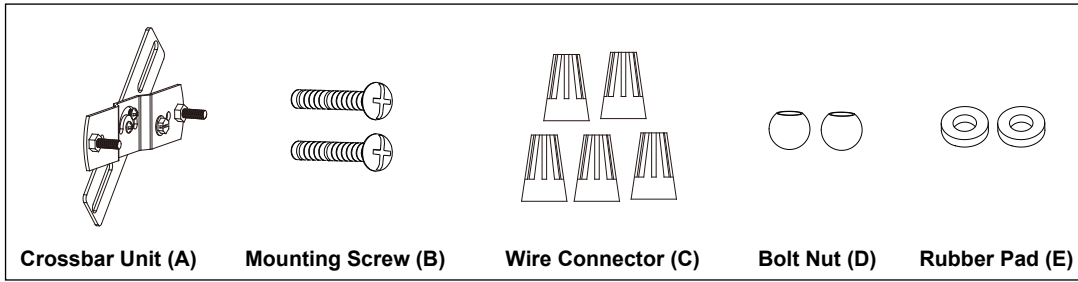

→
Assembly Kit
5798MM (1 SET) for T0351
5993MM (1 SET) for T0495

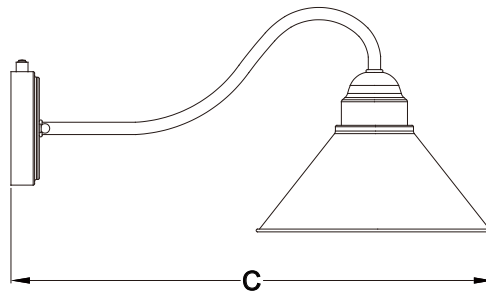
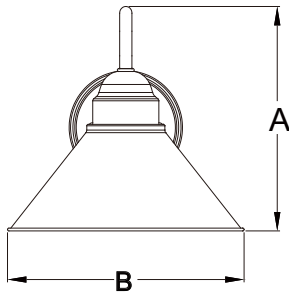

A: 9-1/2"

B: 12"

C: 21"

5 Year Limited Warranty

Vaxcel warrants all of our products against defects in workmanship and finishes for one year following the date of shipment.

In addition:

- Any product with an integrated motion sensor or dusk-to-dawn photocell is supported by a 5-year warranty for the functionality of the product.
- Any product with integrated LED modules is covered by a 5-year warranty on the LED functionality.

Exclusions: This warranty does not include the failure of products from extreme acts of nature; environmental conditions not suited for the products intended use; operation in temperatures outside of the range specified in the instruction manual; usage with improper power supply, power surges or dips. For coastal locations, some corrosion is considered normal for the environment.

Vaxcel reserves the right to repair, replace or issue a credit for any properly installed product, provided it is returned per RMA instruction. This warranty is limited to the cost of the product only and does not extend to transportation, installation or replacement costs.

How can warranty service be obtained?

info@vaxcel.com
1-800-482-9235