

# ASSEMBLY AND INSTALLATION INSTRUCTIONS

T0331 & T0332

**WARNING:** TO AVOID RISK OF ELECTRICAL SHOCK, BE SURE TO SHUT OFF POWER BEFORE INSTALLING OR SERVICING THIS FIXTURE.

**NOTES:** 1. Before installing, consult local electrical codes for wiring and grounding requirements.  
2. READ AND SAVE THESE INSTRUCTIONS.

## Hardware Package (included):

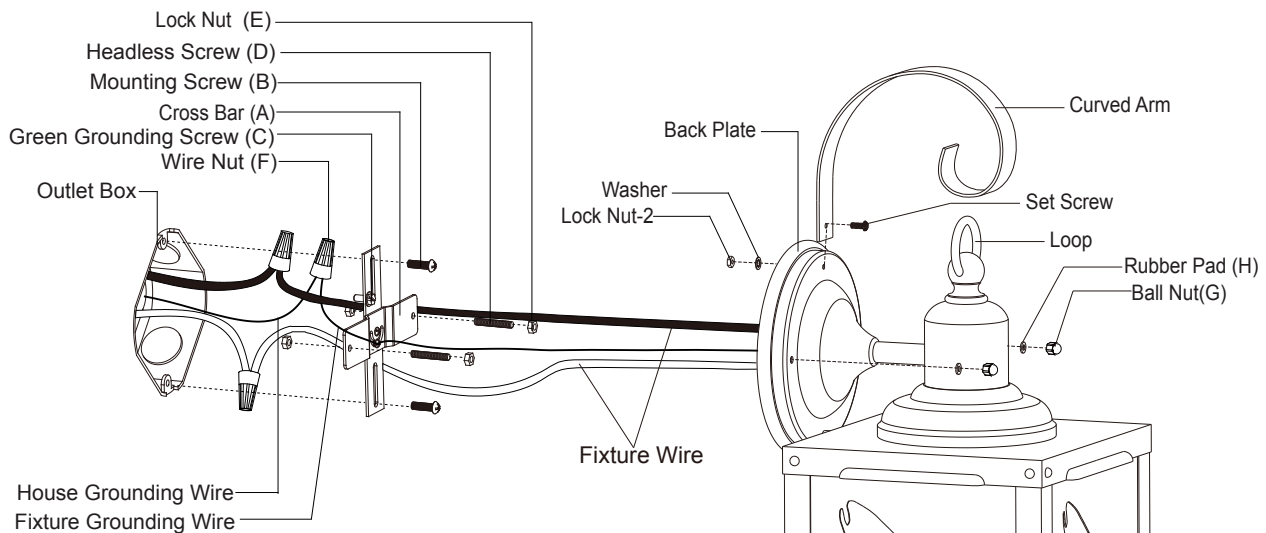
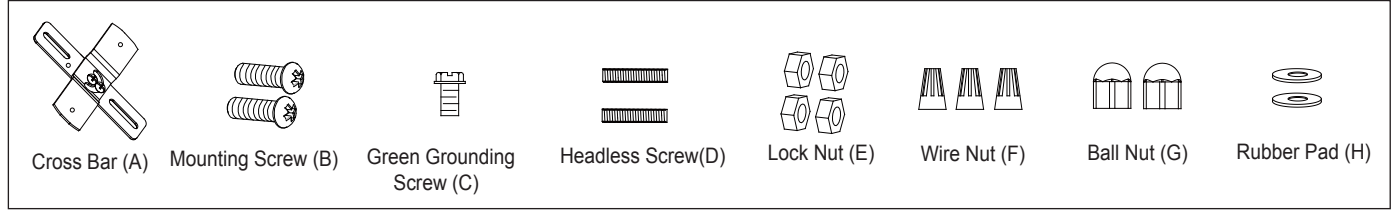

## Installation Steps

Turn off the power at fuse or circuit box.

1. Thread two headless screws through the cross bar, and then secure them with four lock nuts (two on each side of the cross bar). Adjust the length of the headless screws if necessary.  
**Note: Make sure that the headless screws are lined up horizontally to make the fixture level.**

2. Attach cross bar to the outlet box using two mounting screws.

3. Unscrew the set screw, lock nut-2 and washer.

4. Hook the curved arm to the loop, and then attach the curved arm to the back plate by using the set screw, washer and lock nut-2.

5. Pull out the source wires from the outlet box. Make wire connections using wire nuts as follows:
  - Connect the hot wire (usually black insulation) from the fixture to the black wire from the power source.
  - Connect the neutral wire (usually white insulation) from the fixture to the white wire from the power source.
  - Attach the fixture grounding wire (usually green insulation or bare wire) to the cross bar with the green grounding screw, and then connect it to the house grounding wire with the wire nut.

Carefully put the wires back into the outlet box.

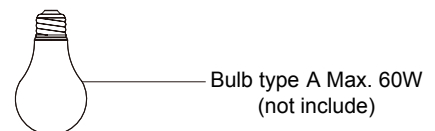

6. Attach the back plate to the cross bar by inserting two headless screws, and then secure it with two rubber pads and two ball nuts.

**NOTE: With silicone caulking compound, caulk completely around where the back plate meets with the wall surface to prevent water from seeping into the outlet box.**

7. Install a bulb (not included). Check relamping label at socket area or packaging for maximum allowed wattage.

Turn on the power at fuse or circuit box

The following parts are available for re-order if damaged or missing.

**Spare Parts List:**

				Assembly Kit 5622MM (1 SET)	
Cross Bar (A)	Mounting Screw (B)	Green Grounding Screw (C)	Headless Screw (D)		
				Mounting Hardware 3098CA	
Lock Nut (E)	Wire Nut (F)	Ball Nut (G)	Rubber Pad (H)		
Curved Arm	Set Screw	Washer	Lock Nut-2		

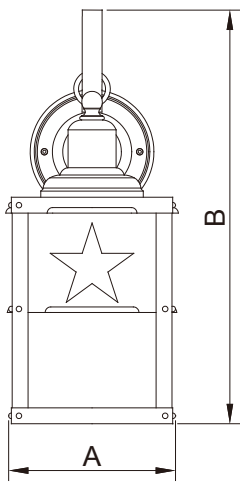

T0331

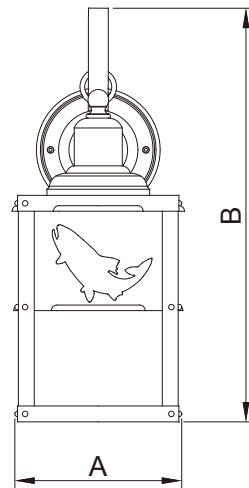
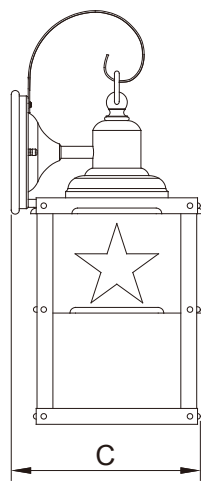

T0332

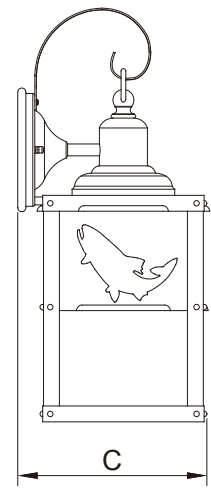

A: 5" B: 13" C: 6"