

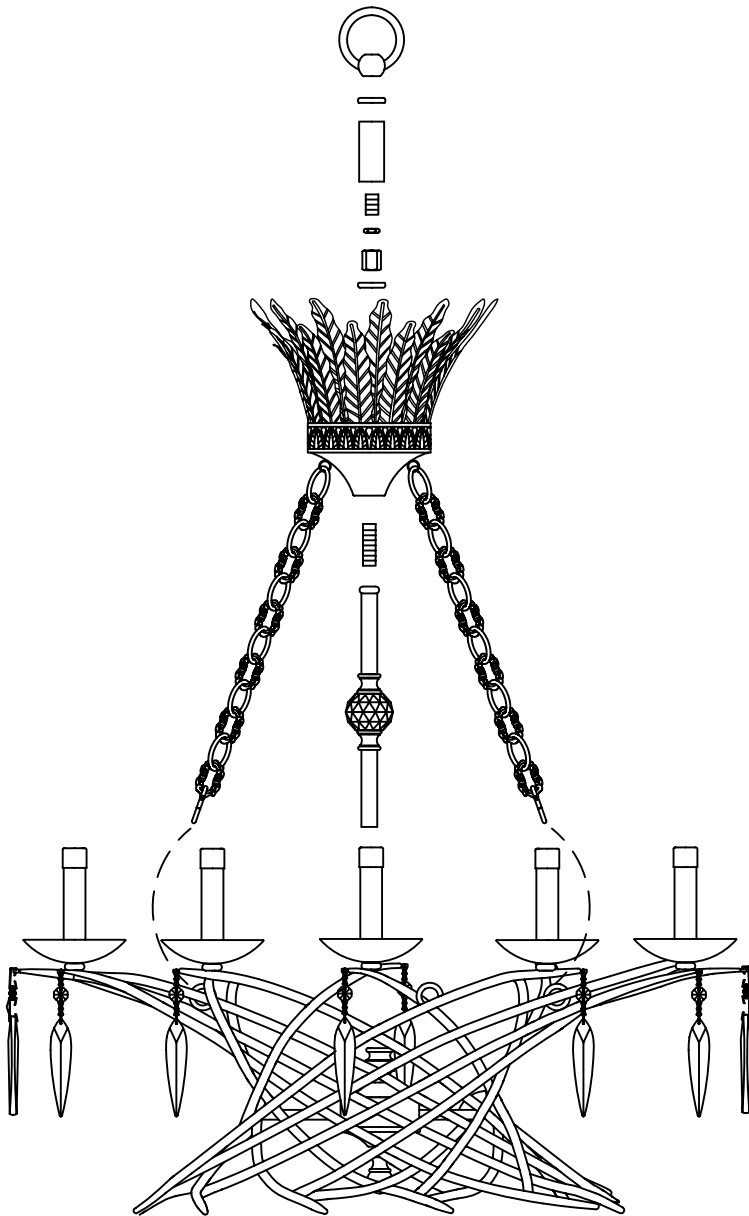

UTTERMOST

21205
21206



22257

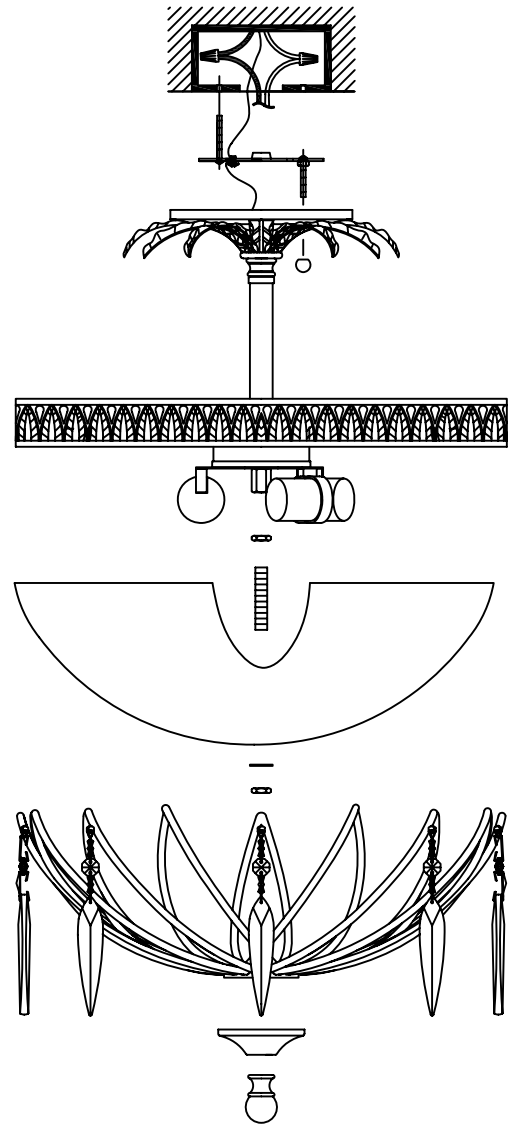



UTTERMOST

INSTALLATION INSTRUCTIONS

PLEASE READ CAREFULLY AND SAVE THESE INSTRUCTIONS, AS YOU MAY NEED THEM AT A LATER DATE.

CAUTION – Turn off the main power at the circuit breaker before installing the fixture, in order to prevent possible shock.

Remove the fixture and the mounting package from the box and make sure that no parts are missing by referencing the illustrations on the installation instructions.

FOR CEILING MOUNT (Fig. 4 & 5)

1.A) Place the #8-32 HEX NUTS (3.) onto the #8-32 FIXTURE MOUNTING SCREWS (4.), and attach the FIXTURE MOUNTING SCREWS to the MOUNTING BRACKET (2.), or universal mounting plate (whichever is provided). Do not tighten the HEX NUTS at this time. (Fig.4)

B) If the fixture uses a single 1/8" IPS NIPPLE (4.) for mounting, thread the 1/8" IPS HEX NUT (3.) onto the NIPPLE, and screw the NIPPLE into the MOUNTING BRACKET (2.), without tightening the HEX NUT. (Fig.5)

2.Pull the power supply wires out from the OUTLET BOX (1.), and mount the MOUNTING BRACKET (2.) or the universal mounting plate to the OUTLET BOX, using MOUNTING SCREWS (10.)

3. Attach the power supply wires to the fixture lead wires by connecting BLACK to BLACK (or SMOOTH), and WHITE to WHITE (or RIBBED). Attach the POWER SUPPLY GROUND WIRE (7.) from the OUTLET BOX (1.), connect FIXTURE GROUND WIRE (8.) and POWER SUPPLY GROUND WIRE together using the correct size of wire connectors. Place connected wires inside of the OUTLET BOX.

4.Place the CANOPY (11.) on the fixture over the OUTLET BOX (1.) and onto the fixture mounting screws [or NIPPLE (4.)], and adjust the #8-32 fixture mounting screws (or NIPPLE) until they protrude out from the CANOPY 1/4". Remove the CANOPY and secure the position of the fixture mounting screws (or NIPPLE) by tightening the HEX NUT (S) (3.) against the MOUNTING BRACKET (2.). Place the CANOPY back onto the fixture mounting screws, (or NIPPLE), and secure into place using the DECORATIVE NUTS (12.) provided.

5.Screw in light bulbs that do not exceed the maximum wattage specified on the fixture's wattage rating label, into the socket(s) on the fixture.
INSTALLATION COMPLETED

FOR CHAIN-SUSPENDED CEILING MOUNT (Fig. 6)

1.Screw the 1/8" IPS HEX NUTS (5.) onto the 1/8" IPS NIPPLE (4.), and then attach the end of the NIPPLE that has the HEX NUT to the MOUNTING BRACKET (2.). Do not tighten the HEX NUT. Pull the SUPPLY GROUND WIRES (8.) out from the OUTLET BOX (1.), and attach the MOUNTING BRACKET (2.) assembly to the OUTLET BOX, by using the slotted holes on the MOUNTING BRACKET and the MOUNTING SCREWS (3.) provided.

2.Thread a 1/8" IPS HEX NUT (5.), and the SCREW COLLAR LOOP (6.) onto the NIPPLE (4.) end that is facing down, but do not tighten the HEX NUT. Place the CANOPY (15.) over the OUTLET BOX (1.) and adjust the SCREW COLLAR LOOP and NIPPLE until the outside threads on the SCREW COLLAR LOOP is centered with the center hole opening of the CANOPY. Take away the CANOPY and tighten the HEX NUTS down on the MOUNTING BRACKET (2.), and the SCREW COLLAR LOOP.

3.Open up the end links of the CHAIN (17.) and attach one end of the CHAIN onto the FIXTURE LOOP (18.). Slide the THREADED RING (16.) from the SCREW COLLAR LOOP (6.), and the CANOPY (15.) onto the CHAIN in that order, and attach the other end of the CHAIN on to the SCREW COLLAR LOOP. Close the ends of the chain links.

4.Unravel the fixture's lead and ground wires and thread the lead and ground wires through every other link of the CHAIN (17.), and out through the SCREW COLLAR LOOP (6.) and NIPPLE (4.) assembly, starting with the chain link attached to the FIXTURE'S LOOP (18.).

5.Attach the power supply wires to the fixture lead wires by connecting the BLACK POWER SUPPLY WIRE (11.) to the SMOOTH FIXTURE LEAD WIRE (12.), and the WHITE POWER SUPPLY WIRE (9.) to the RIBBED FIXTURE LEAD WIRE (10.). Attach the SUPPLY GROUND WIRE (8.) from the OUTLET BOX (1.), connect FIXTURE GROUND WIRE (7.) and POWER SUPPLY GROUND WIRE together using the correct size of wire connectors. Place connected wires inside of the OUTLET BOX.

6.Slide the CANOPY (15.) and the THREADED RING (16.) of the SCREW COLLAR LOOP (6.) up the CHAIN (17.). Place the CANOPY over the OUTLET BOX (1.), and secure in place by screwing the THREADED RING onto the SCREW COLLAR LOOP.

7.Screw in light bulbs that do not exceed the maximum wattage specified on the fixture's wattage rating label, into the socket(s) on the fixture.

NOTE: If the bottom opening of the lamp compartment to the fixture is too narrow to allow access to the light bulb(s), unscrew the two decorative screws at the top of the lamp compartment to allow it to drop down for lamp replacement.

INSTALLATION COMPLETED

