



TRUE RESIDENTIAL®

15 INCH TRUE ICE® MACHINE INSTALL GUIDE AND USER'S MANUAL



PRESERVE THE MOMENT®



829867-F

THANK YOU

FOR YOUR PURCHASE



PRESERVE THE MOMENT®

LUXURY REFRIGERATION WITH COMMERCIAL DNA



CONTENTS

INSTALLATION CHECKLIST	6	PRIOR TO INSTALLATION	
15 INCH TRUE ICE® MACHINE MODELS	7	ROUGH OPENING	16
		ANTI-SWEAT FOAM END PANELS	16
		WATER LINE, DRAIN LINE, & POWER CORD LOCATIONS	16
		PLAN VIEWS	17
		CUSTOM PANEL SPECIFICATIONS	19
		CUSTOM PANEL INSTALLATION	21
		ELECTRICAL INSTALLATION & SAFETY	23
		DRAIN CONNECTION	24
		WATER SUPPLY	27
		INSTALLATION	
		UNCRATING	30
		LEVELING LEGS	31
		LEVELING	31
		KICKPLATE INSTALLATION	31
		WATER FILTER INSTALLATION	32
SAFETY INFORMATION & OWNERSHIP			
FEATURES OF THE TRUE ICE® MACHINE	10		
OWNERSHIP	11		
REFRIGERANT SAFETY & WARNING INFORMATION	11		
SAFETY LABELS & LOCATIONS	11		
BASIC SAFETY PRECAUTIONS & WARNINGS	13		
PROPER DISPOSAL OF THE APPLIANCE	13		
APPLIANCE LOCATION & SPECIFICATIONS	14		
CONTACT US	14		
OUTDOOR USE	14		

CONTENTS

APPLIANCE SETUP

ICE SCOOP	34
90° DOORSTOP INSTALLATION (OPTIONAL ACCESSORY)	34

APPLIANCE OPERATION

BEFORE OPERATING	36
BREAKER RESET	36
POWER SEQUENCE	36
ICE MAKING SEQUENCE	37
ELECTRONIC CONTROL OPERATION	38

GENERAL MAINTENANCE, CARE, & CLEANING

GENERAL MAINTENANCE	46
WATER FILTER REPLACEMENT	47
CONDENSER COIL CLEANING	48
APPLIANCE CARE & CLEANING	49
DESCALING & SANITIZING	51
INTERIOR COMPONENTS	55
WINTERIZING	58

SERVICING, REPLACING COMPONENTS & ADJUSTMENTS

SERVICING & REPLACING COMPONENTS	60
REVERSING DOOR	60
DOOR ADJUSTMENT	63
HANDLE TIGHTENING	63
CONTACT US	63

WARRANTY

LIMITED ICE MACHINE WARRANTY	64
------------------------------	----

INSTALLATION CHECKLIST

To ensure no part of the installation process has been overlooked, complete the checklist below.

- Has an authorized True dealer or licensed installer inspected stainless steel surfaces for imperfection?
(Cosmetic defects are covered by a limited 30-day warranty)
- Have all packaging materials been removed?
- Is the unit properly leveled with all leveling legs contacting the floor?
- Has the water filter been installed? Has the water supply been turned on?
- Have the water supply and drain connections been made?
- Is the water supply temperature always between 40-100°F (4.4-7.8°C)?
- Has the ice machine drain line been routed into an open drain with no more than 84" (2,133.6 mm) vertical rise for 3/8" O.D. tubing and no more than 100' (30.48 m) run?
- Has the water supply been turned on?
- Is the power cord plugged into a properly grounded three-prong outlet in accordance with all applicable electrical codes?
- Have all connections been checked for water leaks? If not, pour water directly into the ice storage bin to ensure drain pump operation and inspect for leaks.
- Were the ice machine and storage bin disinfected prior to use? If not, see "Sanitize" (pg. 54).
- Has the ice machine been turned on? During the initial fill, can you hear the water valve turn on and see water filling the reservoir tank?
- After the first ice cycle, did all 24 ice cubes fall into the bin during harvest?
- Has the ice produced in the first hour of operation been discarded?
- Has the customer reviewed the unit's operation in this manual?
- Has the customer reviewed the schedule of maintenance of the machine?

15 INCH TRUE ICE® MACHINE MODELS

15" STAINLESS STEEL



TUI-15-R/L-SS-D

15" OVERLAY PANEL



TUI-15-R/L-OP-D

15" CUSTOM FINISH



TUI-15-R/L-OP-D-DSK-103-H08

Customize your True with a variety of finish and hardware options at true-residential.com/custom/

TRUE CUSTOM COLORS

MATTE WHITE	ANTIQUE WHITE	SAFFRON	COBALT	JUNIPER	SAGE	BLUESTONE	EMERALD	ULTRA MATTE BLACK	MATTE BLACK	GLOSS BLACK
030	050	103	078	104	129	152	086	085	027	044

CUSTOM HARDWARE

BRASS	CHROME	COPPER	STAINLESS	PEWTER	GOLD
H01	H02	H03	H04	H05	H08

FEATURES OF THE TRUE ICE® MACHINE

OWNERSHIP

REFRIGERANT SAFETY & WARNING INFORMATION

SAFETY LABELS & LOCATIONS

BASIC SAFETY PRECAUTIONS & WARNINGS

PROPER DISPOSAL OF THE APPLIANCE

APPLIANCE LOCATION & SPECIFICATIONS

CONTACT US

OUTDOOR USE



PRESERVE THE MOMENT®

FEATURES OF THE TRUE ICE MACHINE

- Produces up to 85 lb (38.5 kg) of ultra-clear gourmet ice cubes per day.
- Stores 28 lb (12.7 kg) of ice cubes.
- Precision Ice-Size control for adjusting to the perfect cube size.
- **Time-of-Flight** technology allows for adjusting the ice level with the push of a button.
- Three-Character LED display tells you what your machine is doing.
- Auto-clean sequence for walk-away cleaning simplicity.
- Drain Pump standard on all models.
- Built-in water filter with automatic filter change reminders.
- Fourteen-Color LED bin light.
- High quality True magnetic ice scoop.
- Advanced diagnostics for safe reliable operation.
- Reversible Soft-Close hinges for installation flexibility.
- U.L. approved for outdoor use.
- Industry-leading True Warranty.



Performance Specifications

*Max Ice Production	85 lb (38.5 kg) / day
**Rated Ice Production	75 lb (34 kg) / day
**Rated Water Consumption	25 gal / 100 lb
**Rated Electrical Consumption	6.95 kWh / 100 lb

*Performance rated at 70°F (21.1°C) air / 50°F (10°C) water / 30 psig (206.8 kPa) water pressure
 **Performance rated at 90°F (32.2°C) air / 70°F (21.1°C) water / 30 psig (206.8 kPa) water pressure

OWNERSHIP

To ensure that your unit works properly from the first day, it must be installed properly. We highly recommend a trained refrigeration mechanic and electrician install your True equipment. The cost of a professional installation is money well spent.

Before you start to install your TRUE unit, carefully inspect it for freight damage. **If damage is discovered, DO NOT INSTALL THE UNIT or put it in service.** Notify True customer service, and immediately file a claim with the delivery freight carrier.

TRUE is not responsible for damage incurred during shipment.

For any questions about installation, please contact your True dealer or True Residential Technical Service at **844-746-9423** or **TrueResidentialService@TrueMfg.com**. Please have your model and serial number available.



NOTICE: PROPER INSTALLATION REQUIRES A CONNECTION TO THE WATER SUPPLY, A DRAIN, AND A DEDICATED ELECTRICAL CIRCUIT.

THESE CONNECTIONS ARE THE RESPONSIBILITIES OF THE INSTALLER. IMPROPER CONNECTIONS CAN RESULT IN PERSONAL INJURY, PROPERTY DAMAGE AND IMPROPER OPERATION. THE ICE MACHINE MUST BE INSTALLED ACCORDING TO ALL APPLICABLE NATIONAL, STATE AND LOCAL CODES AND REGULATIONS.

REFRIGERANT SAFETY & WARNING INFORMATION

See the serial label inside the appliance for the units refrigeration type. For Hydrocarbon Refrigeration (R-600a only), see below:



DANGER! Risk of fire or explosion. Flammable refrigerant used.

- **DO NOT** use mechanical devices to accelerate the defrost process or to clean.

- **DO NOT** puncture, pierce, or burn refrigerant tubing.
- Be aware that refrigerants may not contain an odor.
- Store the appliance in a room without continuously operating ignition sources.
- Follow handling instructions carefully.
- To be repaired only by trained service personnel.
- Consult repair manual/owner's guide before attempting to service this product. All safety precautions must be followed.
- Dispose of properly in accordance with local and federal regulations. Follow all safety precautions.



CAUTION! Keep all ventilation openings clear of obstruction in the appliance enclosure or in the structure housing the appliance.

SAFETY LABELS & WARNING

Your new ice machine has labels placed in specific locations throughout the appliance which identify important safety information. Please take a moment to familiarize yourself with the content and label locations.



FIG. 1. Example of safety label locations. Not all labels or locations shown.

ON THE REAR PANEL

	⚠ WARNING RISK OF FIRE OR EXPLOSION. DISPOSE OF PROPERLY IN ACCORDANCE WITH FEDERAL OR LOCAL REGULATIONS. FLAMMABLE REFRIGERANT USED.
	⚠ ATTENTION RISQUE DE FEU OU D'EXPLOSION. ÉLIMINER CONFORMÉMENT AUX RÈGLEMENTS FÉDÉRAUX OU LOCAUX. LE FRIGORIGÈNE EST INFLAMMABLE.

PART # 224556

	⚠ CAUTION RISK OF FIRE OR EXPLOSION DUE TO PUNCTURE OF REFRIGERANT TUBING; FOLLOW HANDLING INSTRUCTIONS CAREFULLY. FLAMMABLE REFRIGERANT USED.
	⚠ CAUTION RISQUE DE FEU OU D'EXPLOSION SI LA TUBULURE CONTENANT LE FRIGORIGÈNE EST PERFORÉE. SUIVRE LES INSTRUCTIONS DE MANUTENTION AVEC SOIN. LE FRIGORIGÈNE EST INFLAMMABLE.

PART # 224558

	⚠ CAUTION HAZARDOUS MOVING PARTS Moving parts can cut. Keep hands clear when panels removed.
	⚠ ATTENTION PIÈCES EN MOUVEMENT DANGEREUSES Ils peuvent couper. Tenir les mains à l'écart quand panneaux retirés.

PART # 972946

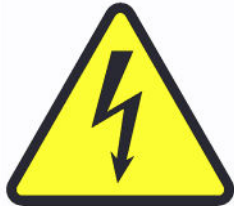
	⚠ WARNING HAZARDOUS VOLTAGE Risk of electric shock. Disconnect power before servicing the unit.
	⚠ ADVERTISSEMENT DANGEREUX TENSION Débrancher l'alimentation avant de procéder à l'entretien de l'unité.

PART # 972948

INSIDE THE COMPRESSOR COMPARTMENT

	⚠ DANGER RISK OF FIRE OR EXPLOSION. FLAMMABLE REFRIGERANT USED. TO BE REPAIRED ONLY BY TRAINED SERVICE PERSONNEL. DO NOT PUNCTURE REFRIGERANT TUBING.
	⚠ DANGER RISQUE DE FEU OU D'EXPLOSION. LE FRIGORIGÈNE EST INFLAMMABLE. CONFIER LES RÉPARATIONS À UN TECHNICIEN SPÉCIALISÉ. NE PAS PERFORER LA TUBULURE CONTENANT LE FRIGORIGÈNE.

PART # 224559

	⚠ CAUTION HAZARDOUS MOVING PARTS Moving parts can cut. Keep hands clear when panels removed.
	⚠ ATTENTION PIÈCES EN MOUVEMENT DANGEREUSES Ils peuvent couper. Tenir les mains à l'écart quand panneaux retirés.

PART # 972946

	⚠ CAUTION RISK OF FIRE OR EXPLOSION. FLAMMABLE REFRIGERANT USED. CONSULT REPAIR MANUAL / OWNER'S BEFORE ATTEMPTING TO SERVICE THIS PRODUCT. ALL SAFETY PRECAUTIONS MUST BE FOLLOWED.
	⚠ CAUTION RISQUE DE FEU OU D'EXPLOSION. LE FRIGORIGÈNE EST INFLAMMABLE. CONSULTER LE MANUAL DU PROPRIÉTAIRE / GUIDE DE RÉPARATION AVANT DE TENTER UNE RÉPARATION. TOUTES LES MESURES DE SÉCURITÉ DOIVENT ÊTRE RESPECTÉES.

PART # 224555

BENEATH THE EVAPORATOR COVER'S TOP PANEL

	⚠ DANGER RISK OF FIRE OR EXPLOSION. FLAMMABLE REFRIGERANT USED. DO NOT USE MECHANICAL DEVICES TO DEFROST ICE MACHINE. DO NOT PUNCTURE REFRIGERANT TUBING.
	⚠ DANGER RISQUE DE FEU OU D'EXPLOSION. LE FRIGORIGÈNE EST INFLAMMABLE. NE PAS UTILISER D'APPAREILS MÉCANIQUES POUR DÉGIVRER LA MACHINE À GLACE. NE PAS PERFORER LA TUBULURE CONTENANT LE FRIGORIGÈNE.

PART # 224667

BASIC SAFETY & WARNING PRECAUTIONS

- Take care during operation, maintenance or repairs to avoid cuts or pinching from any part/component of the appliance.
- Units may pose a tipping hazard while uncrating, during installation, or when moving the unit.
- Ensure the unit is properly installed and located in accordance with the Installation Instructions before use.
- This appliance is not to be used, cleaned or maintained by persons (including children) with reduced physical, sensory or mental capabilities or lack of experience and knowledge, unless they have been given supervision or instruction.
- **DO NOT** allow children to play with the appliance or climb, stand, or hang on the unit's shelves to prevent damage to the refrigerator and personal injury.
- **DO NOT** touch the cold surfaces in the freezer compartment when hands are damp or wet. Skin may stick to these extremely cold surfaces.
- Unplug the ice machine before cleaning and making repairs.
- Powering off the ice machine will not remove power from all components (e.g., light circuit and drain pump).
- **DO NOT** store or use gasoline, or other flammable vapors and liquids, in the vicinity of this or any other appliance.
- **DO NOT** store explosive substances such as aerosol cans with a flammable propellant in this appliance.
- Keep fingers out of the "pinch point" areas; clearances between the doors and appliance are necessarily small; be careful closing doors when children are in the area.

- **DO NOT** use electrical appliances inside the food storage compartments of the units unless the appliances are of the type recommended by the manufacturer.

NOTE: ALL SERVICING MUST BE PERFORMED BY A QUALIFIED TECHNICIAN.

PROPER DISPOSAL OF THE APPLIANCE



DANGER! RISK OF CHILD ENTRAPMENT

Child entrapment and suffocation are not problems of the past. Junked or abandoned appliances are still dangerous, even if they will sit for "just a few days." If you are getting rid of your old appliance, please follow the instructions below to help prevent accidents.

Before throwing away your old ice machine:

Take off the door.



DANGER! Risk of fire or explosion. Flammable insulation and/or refrigerant used. Dispose of all in accordance with local and federal regulations. Follow all safety precautions.

APPLIANCE LOCATION & SPECIFICATIONS

For more information regarding the installation location or appliance specifications, please see "Prior to Installation" starting on pg. 16.

- Appliance is certified to NSF Standard 12.
- Appliance is UL rated for outdoor use.
- Appliance is not suitable for an area where a pressure washer or hose may be used.
- Ensure the location will provide adequate clearances and sufficient airflow for the appliance.
- Ensure the power supply for the appliance matches the appliance specification sheet or appliance data plate and is within the rated voltage ($\pm 5\%$). Also, ensure the amperage rating of the circuit is correct and the circuit is properly grounded.
- The appliance should always be plugged into its own individual dedicated electrical circuit. The use of adapter plugs and extension cords is prohibited.

CONTACT US

For any questions about installation, please contact your TRUE dealer or TRUE Residential Technical Service. Please have your model and serial number (see serial label location below) available so we can better assist you with your service- or parts-related inquiries.

Customer Service

Phone: 888-616-8783
info@true-residential.com

Warranty Department

Phone: 844-849-6179
TrueResidentialWarranty@truemfg.com

Technical Service Department

Phone: 844-746-9423
TrueResidentialService@truemfg.com

SERIAL LABEL LOCATION

Your serial label contains important information such as your model and serial number. The label is located on the upper left interior wall.

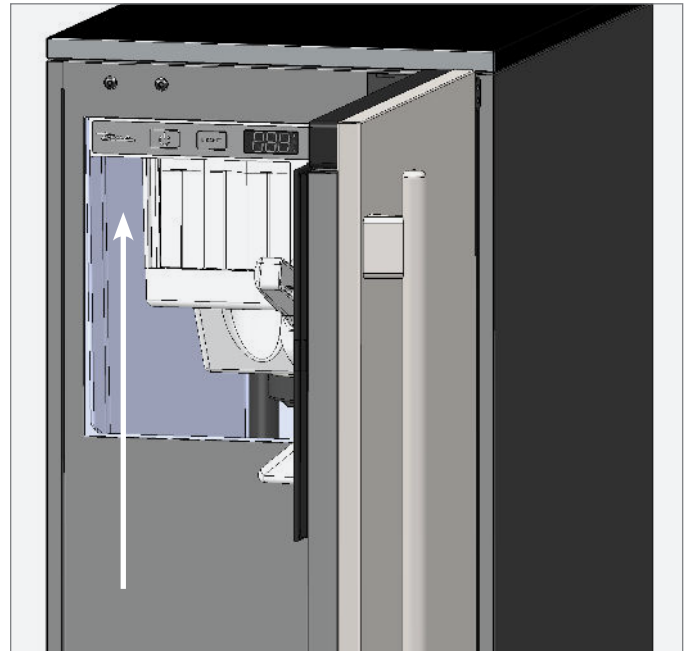

OUTDOOR USE

All True undercounter ice machines are rated for outdoor use.

- The unit must be covered or otherwise protected from direct exposure to rain.
- For the safest possible outdoor installation, build the unit into an undercounter kitchenette area within stone, brick, wood, etc.
- If the unit is expected to be exposed to low air temperatures for a prolonged period of time, please turn the unit off and winterize the unit. See "Winterizing" (pg. 58).



NOTICE: DO NOT ALLOW THE ICE MACHINE TO BE EXPOSED TO TEMPERATURES BELOW 32°F (0°C) WITHOUT WINTERIZING THE UNIT AS THIS WILL CAUSE ANY WATER IN THE MACHINE TO FREEZE. FAILURES CAUSED BY EXPOSURE TO FREEZING TEMPERATURES ARE NOT COVERED BY THE WARRANTY.

ROUGH OPENING

ANTI-SWEAT FOAM END PANELS

WATER LINE, DRAIN LINE, AND POWER CORD LOCATIONS

PLAN VIEWS

CUSTOM PANEL SPECIFICATIONS

CUSTOM PANEL INSTALLATION

ELECTRICAL INSTALLATION & SAFETY

DRAIN CONNECTION

WATER SUPPLY



PRESERVE THE MOMENT®

PRIOR TO INSTALLATION

Allowable Air and Water Temperatures and Pressures

	Air Temperature	Water Temperature	Water Pressure
Minimum	40°F (4.4°C)	40°F (4.4°C)	20 psig (1.4 bar)
Maximum	100°F (37.8°C)	100°F (37.8°C)	80 psig (5.5 bar)

ROUGH OPENING

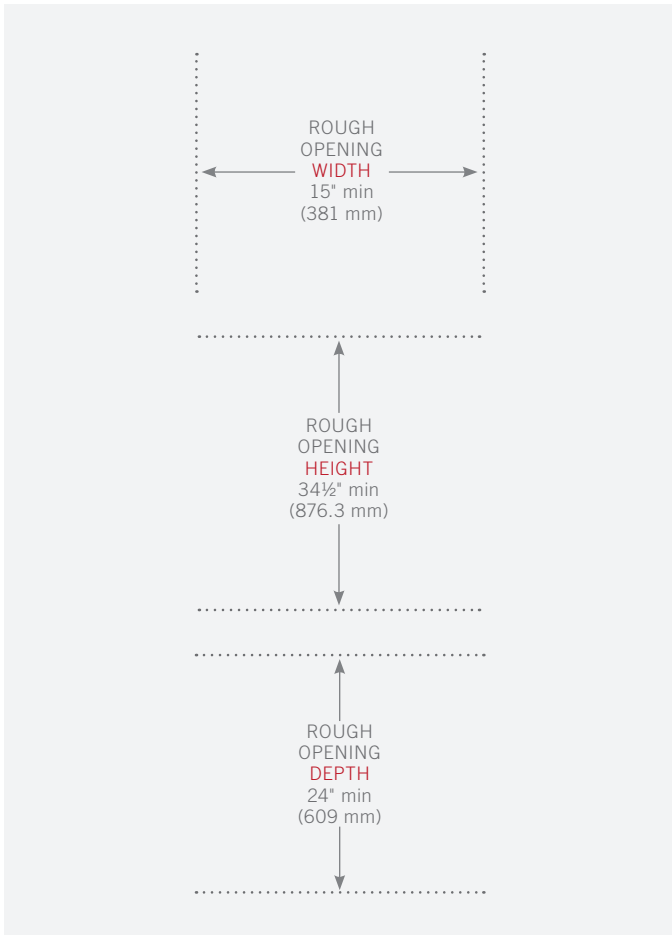

Avoid running wires or plumbing in this area.

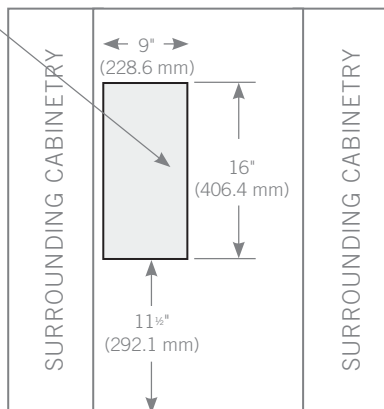

FRONT VIEW OF CABINETS OPENING

ANTI-SWEAT FOAM END PANELS

When installing two or more True units side-by-side, TRUE recommends installing one (1) foam pad between the appliances (on either appliance) to prevent moisture from developing.

To order foam pads, contact our parts department at **844-849-6226** or TrueResidentialParts@TrueMfg.com.

WATER LINE, DRAIN LINE, & POWER CORD LOCATIONS

The ice machine must be installed with adequate clearance for water and drain connections at the rear of the unit.

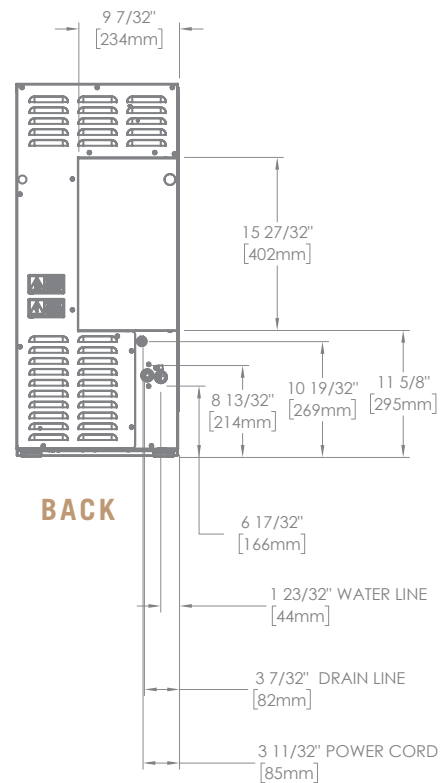

STAINLESS & FINISHED SOLID UNITS

STAINLESS STEEL DOOR



TUI-15-R/L-SS-D

CUSTOM FINISH (DSK)



TUI-15-R/L-OP-D-DSK-103-H08

PLAN VIEW DIMENSIONS

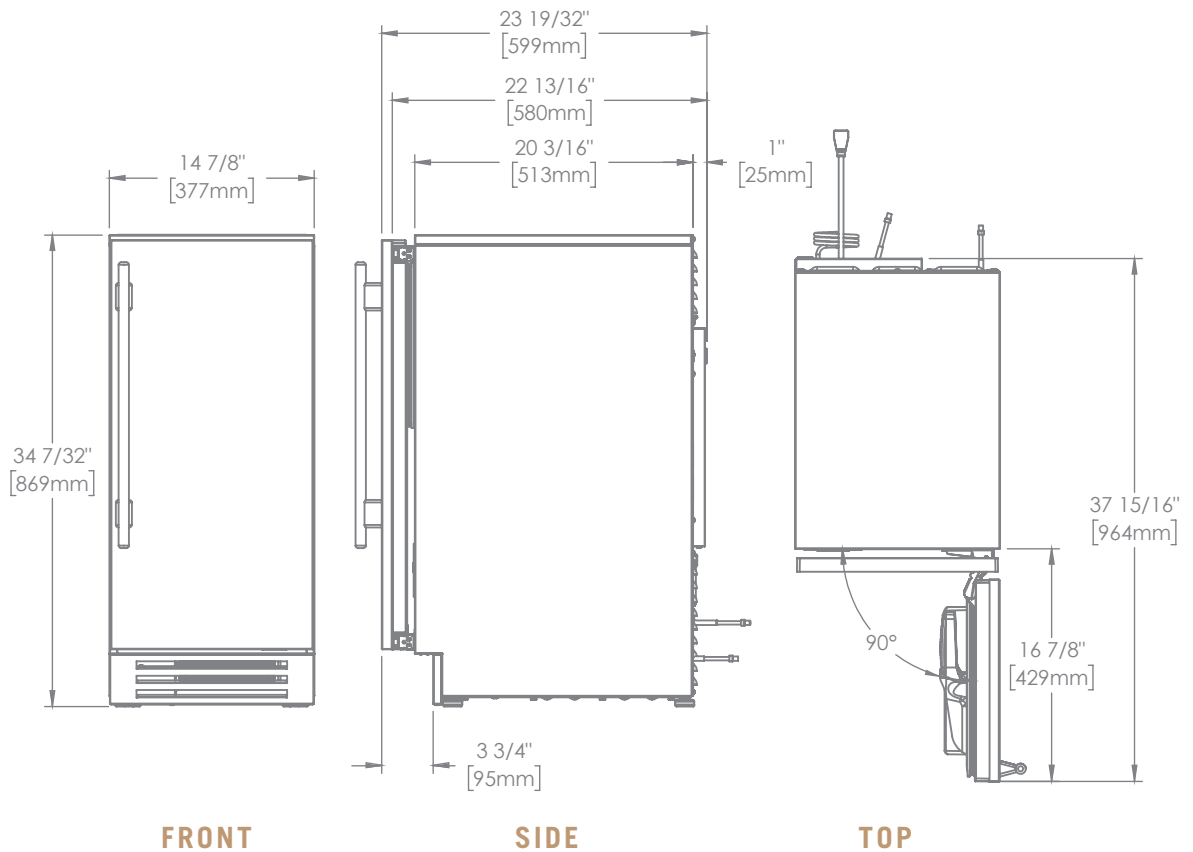

Dimensions may vary by $\pm 1/8$ " (3.2 mm)

SOLID OVERLAY UNITS

SOLID PANEL – READY DOOR (OP)



TUI-15-R/L-OP-D

NOTE: Unit shown with overlay panel provided by others.

PLAN VIEW DIMENSIONS

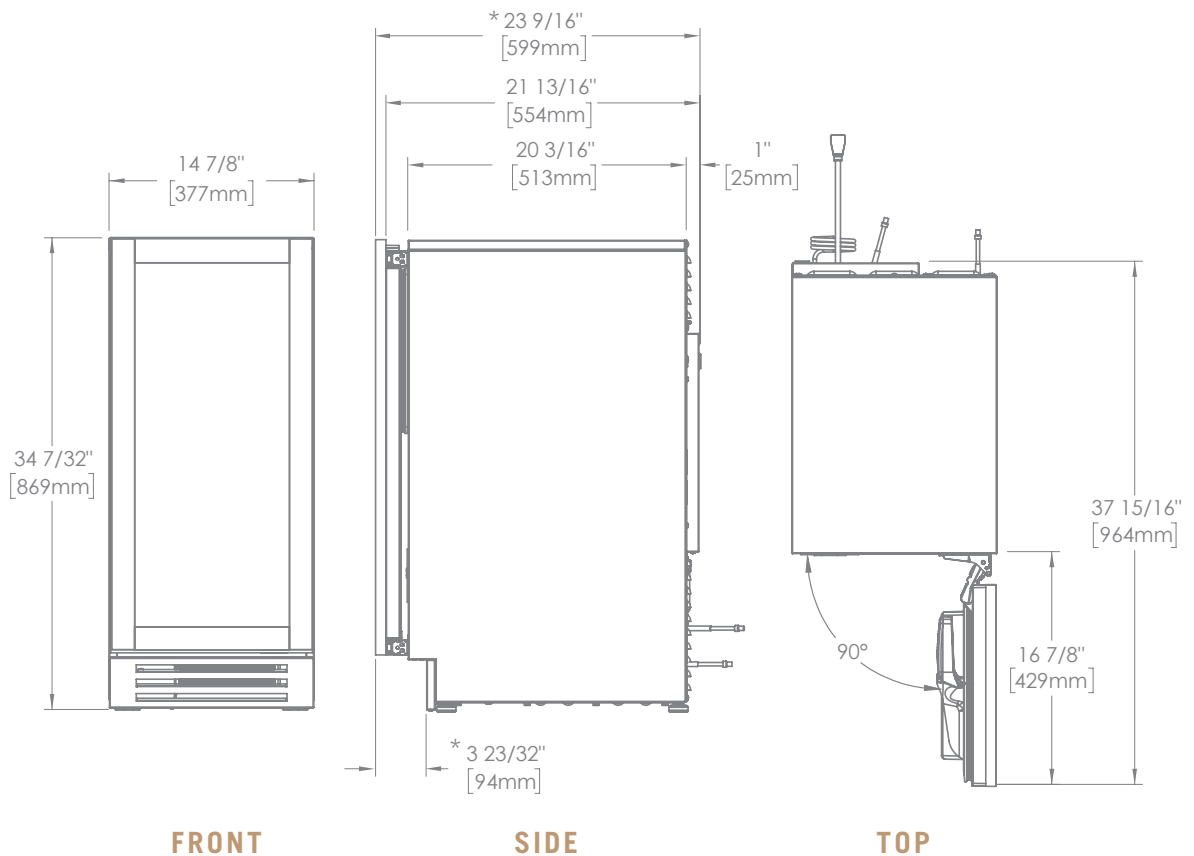

*Measures include 3/4" (19 mm) thick panel (not provided by True) • Dimensions may vary by ± 1/8" (3.2 mm)

CUSTOM PANEL SPECIFICATIONS

Overlay units can be fitted with custom panels to match adjacent cabinetry. The integrated panel option extends above the door to conceal the hinge assembly to match full overlay appliance doors.

See the picture below for reference. For installation instructions, please see “Custom Panel Installation”. (pg. 21).

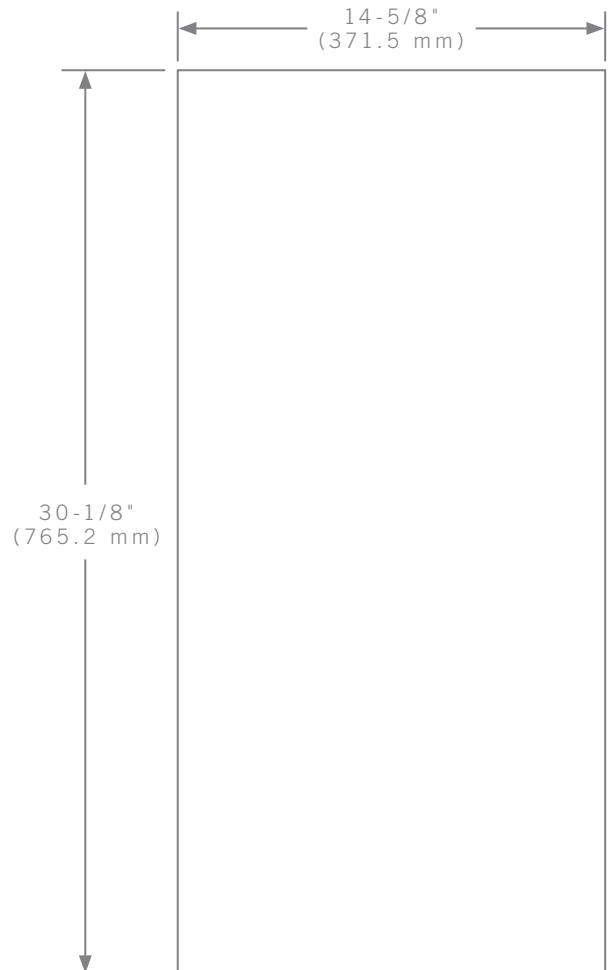

Specifications

Panel Width	14-5/8" (371.5 mm)
Panel Height	30-1/8" (765.2 mm)
Panel Depth	3/4" (19 mm) max
Panel Weight	10 lb (4.5 kg) max
Rail Style Dimension	2" (50.8 mm) min

CUSTOM PANEL SPECIFICATIONS

If so desired, you can replace the kickplate with a custom overlay louver grill. Please see the template below.

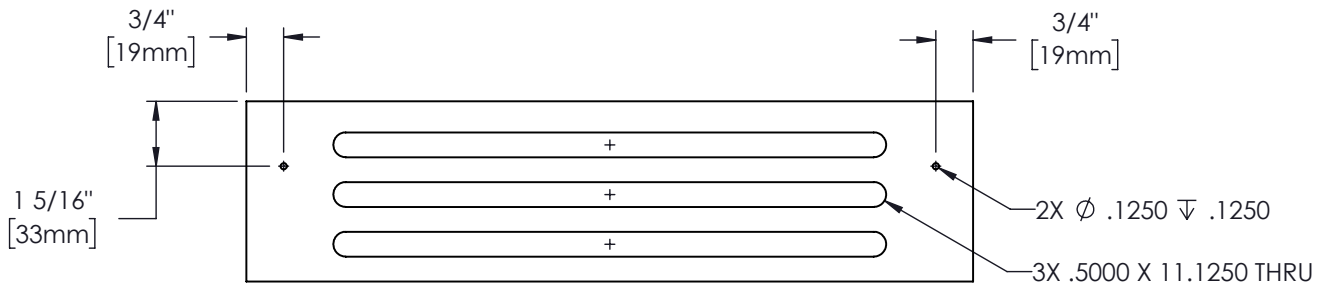
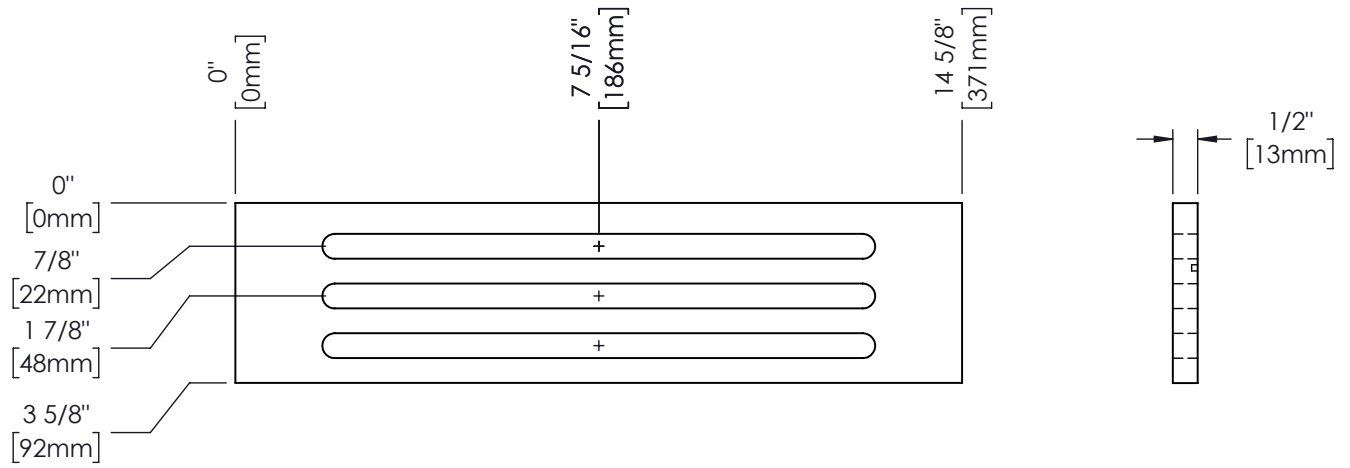

CUSTOM PANEL INSTALLATION

Your new ice machine comes with articulating, or soft-closing, hinges. The hinges can be installed on either the left or right to change the direction the door opens. Before installing panels, be sure the door assembly is oriented as desired. See "Reversing Door" (pg. 60). Please closely read all instructions before installing your panels.

REQUIRED TOOLS

Required tools include (but may not be limited to) the following:

- Surface protection*
- 2+ Clamps ≥ 2 " (51 mm)
- 1/8" Hex Head Allen Wrench
- Phillips Screwdriver or Bit Driver
- 1/8" Drill Bit
- (Qty 6) #6 x 1/2" Screws**
- Drill

*Cardboard, moving blanket, foam padding, etc.

**Screw type varies by panel material.

INSTALLATION

1. Carefully lay the door overlay panel face down on a protected surface.
2. With a 1/8" hex head Allen wrench, loosen the appliance hinge bolts. Then, remove the door. See fig. 1.

NOTE: DO NOT REMOVE THE HINGE FROM THE DOOR ASSEMBLY.

3. If NSF cover is present, carefully pry screw caps from the cover to access the door bracket screws. See fig. 2.

NOTE: THE CAPS ARE INSTALLED WITH A TACKY GLUE THAT CAN BE EASILY REMOVED AND REINSTALLED.

4. Place the door front face down on the overlay panel. Then, align the bottom door bracket's bottom edge with the overlay panel's bottom edge. See figs. 3 and 4.

5. Clamp the door assembly panel.

NOTE: IF THE CLAMP JAWS ARE NOT PADDED, INSERT PADDING BETWEEN THE CLAMP AND THE OVERLAY TO PROTECT THE PANEL'S FINISH.

6. If desired, install a handle before proceeding to the next step. For best installation, fasten the handle with recessed screws.
7. With a 1/8" drill bit, carefully drill pilot holes into the door front. See fig. 5.

NOTE: TAKE CARE TO NOT DRILL THROUGH THE FRONT OF THE PANEL.

8. With the appropriate hardware, fasten the overlay panel to the door front. Then, remove the clamps.
9. Install the door assembly. Be sure to fully tighten the hinge screws.
10. Verify the door closes correctly and seals without gaps. Adjust the door as needed; see "Door Adjustment" (pg. 63).

PRIOR TO INSTALLATION



FIG. 1. Slide the door off the hinge bolts through the keyhole slots.

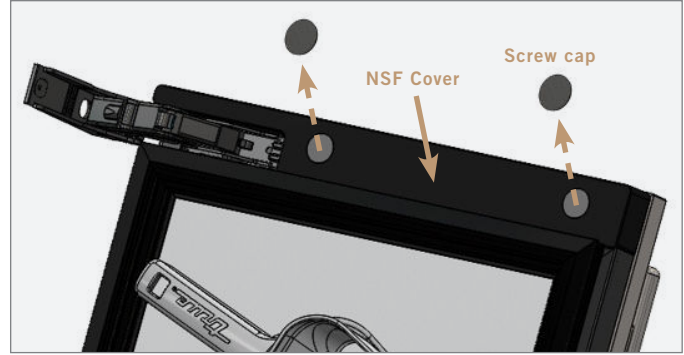

FIG. 2. Remove the NSF cover screw caps.



FIG. 3. Align along the bottom door bracket edge. Front of door assembly shown.

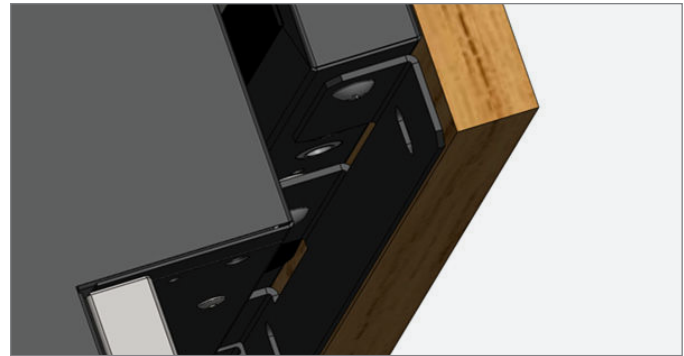

FIG. 4. The bottom edge of the panel should align with the bracket as shown.

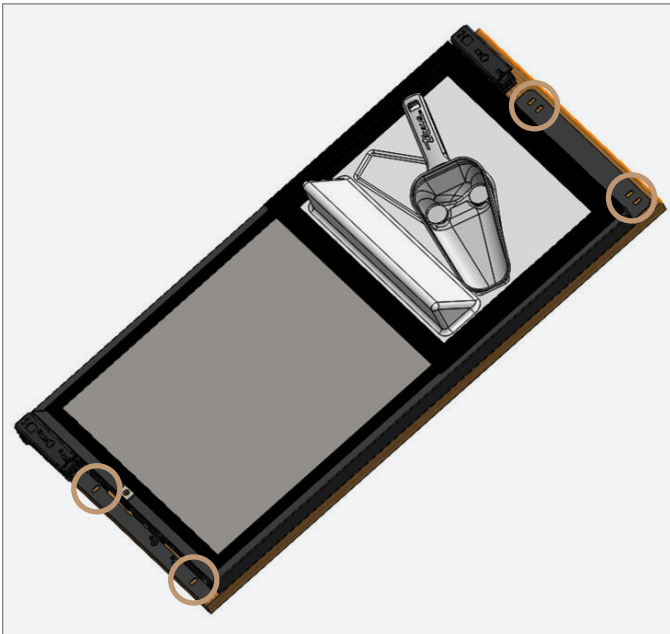

FIG. 5. Carefully fasten the overlay panel to the door front.

ELECTRICAL INSTALLATION & SAFETY

The unit is approved by UL for outdoor installation.

USE OF ADAPTER PLUGS

NEVER USE AN ADAPTER PLUG! An adapter plug alters the original OEM plug configuration when connecting it to a power source.



TRUE will not warranty any ice machine that has been connected to an adapter plug.

USE OF EXTENSION CORDS

NEVER USE AN EXTENSION CORD! An extension cord is determined to be any component that adds length to the original OEM power cord when connecting it to a power source.



TRUE will not warranty any ice machine that has been connected to an extension cord.

HOW TO CONNECT ELECTRICITY

- The ice machine should always be plugged into a dedicated electrical circuit. This provides the best performance and prevents building wiring circuits from being overloaded, which could cause a fire hazard from overheated wires.
- Before your new unit is connected to a power supply, check the incoming voltage with a voltmeter. If the recorded voltage is less than the rated voltage for operation (+/-5%) and amp rating, correct immediately. Refer to appliance data plate for this voltage requirement.
- The electrical outlet must be within 36" (914.4 mm) of the center of the back wall of the ice machine's final location. Outlet must be flush with wall and comply with local electrical codes.
- The wall outlet and circuit should be checked by a licensed electrician to make sure the outlet is properly grounded.
- The power cord of this appliance is equipped with a 3-prong (grounding) plug which mates with a standard 3-prong (grounding) wall outlet to minimize the possibility of electric shock hazard from this appliance. A 115V AC, 60 Hz, 15 amp circuit breaker and electrical supply are required.
- If the outlet is a standard 2-prong outlet, it is your personal responsibility and obligation to have it replaced with the properly grounded wall outlet.
- **DO NOT**, under any circumstances, cut or remove the ground prong from the power cord. For personal safety, this appliance must be properly grounded.
- When moving the ice machine, for any reason, be careful not to roll over or damage the power cord.
- Repair or replace immediately all power cords that have become frayed or otherwise damaged. **DO NOT** use a power cord that shows cracks or abrasion damage along its length or at either end.
- If the supply power cord is damaged, it should be replaced with original equipment manufacturer (OEM) components. To avoid hazard this should be done by a licensed service provider.
- **NEVER** unplug your ice machine by pulling on the power cord. Always grip plug firmly and pull straight out from the outlet.

ELECTRICAL OUTLET LOCATION

To minimize the depth of the cutout opening, the electrical outlet must be positioned as shown below or on pg. 16. Outlet must be flush with wall.

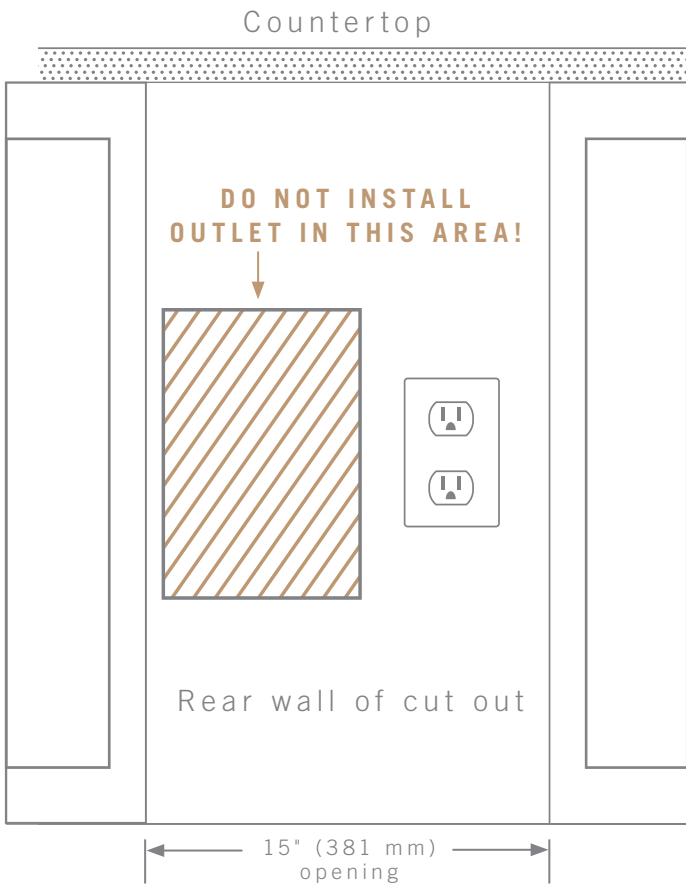

DRAIN CONNECTION

The True Ice® machine has a built-in drain pump.



WARNING! PROPER INSTALLATION REQUIRES CONNECTION TO THE WATER SUPPLY AND A DRAIN. THESE CONNECTIONS ARE THE RESPONSIBILITIES OF THE INSTALLER. TRUE WILL NOT WARRANT LEAKS OR DAMAGE CAUSED BY IMPROPER INSTALLATION. IMPROPER CONNECTIONS CAN RESULT IN PERSONAL INJURY, PROPERTY DAMAGE AND IMPROPER OPERATION. THE ICE MACHINE MUST BE INSTALLED ACCORDING TO ALL APPLICABLE NATIONAL, STATE AND LOCAL CODES AND REGULATIONS.

- **DO NOT** reduce drain connections any smaller than 1/4" I.D.
- 96" (2,438.4 mm) 3/8" O.D. x 1/4" I.D. clear PVC drain hose, 90° 1/2" male NPT x 1/4" O.D. barbed drain fitting, and hose clamp provided by True.
- Check valve required. Check valve and adapter provided by True. See "Check Valve Installation" (pg. 25).
- Using hose larger than 1/2" I.D. may require a larger pump.
- Be sure to use the correct I.D. hose for your vertical rise to ensure the proper flowrate and prevent drain time alarms. For more information, see "Drain Time Alarm" (pg. 40).
- If the installation requires a **vertical rise greater than 84" (2,133.6 mm)** include an external drain pump to cover the additional required pumping height. Connect the drain tube outlet from the ice machine to the external drain pump inlet. **Do not remove the internal drain pump provided with the ice machine.** Altering the internal components in any way will void the warranty.
- **DO NOT USE HOSE SMALLER THAN 1/4" I.D.**
- The floor drain must be large enough to accommodate additional drainage.
- The drain pump discharge line must terminate at an open site drain.
- Be sure to thoroughly inspect all connections after installation to ensure there are no leaks. Use of thread sealant required.

DRAIN LINE INSTALLATION

1. Thread the 1/2" NPT connector into the drain fitting. See fig. 1.

NOTE: THREAD SEALANT REQUIRED AND TO BE SUPPLIED BY INSTALLER.



NOTICE: DO NOT OVERTIGHTEN THE NPT CONNECTOR! DO NOT TORQUE THE CONNECTOR MORE THAN 50 IN-LB (5.65 NM). THIS MAY CAUSE THE FITTING TO CRACK. CHECK THE DRAIN FITTING FOR LEAKS BEFORE COMPLETING THE INSTALLATION.

2. With the clamp on the hose, connect the clear drain hose to the barbed fitting. See fig. 1.
3. Tighten the hose clamp.

NOTE: VERIFY THE ICE MACHINE DRAINS THROUGH TWO CYCLES WITHOUT ANY DRAIN ALARM DURING INSTALLATION.

For more information, see "Drain Time Alarm" (pg. 40).

CHECK VALVE INSTALLATION (REQUIRED)

1. Locate the provided check valve components. See fig. 2.
2. With tubing cutters, cut the drain line near the connection point. See fig. 3.
3. With the water flow arrow (see fig. 4) pointing away from the ice machine, connect the cut drain line to the check valve. See fig. 5. Use the provided adapter if needed.
4. Check the drain system for leaks.

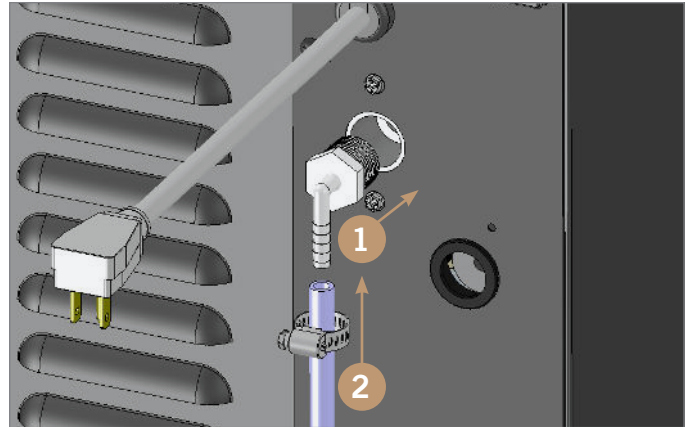

FIG. 1. Be sure to tightly clamp the drain line onto the barbed fitting. Thread sealant required.



FIG. 2. Check valve and adapter shipped inside the ice machine.



FIG. 3. Cut the drain line with tubing cutters.

PRIOR TO INSTALLATION

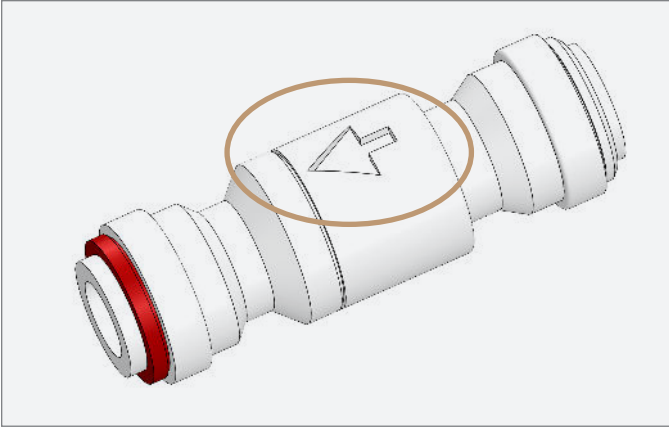

FIG. 4. Water flow arrow on the check valve.



FIG. 5. Installed check valve.

PUMP HEIGHTS

Do not exceed the maximum vertical rise.

	Maximum Vertical Rise	Max Run
3/8" O.D. Hose (provided by TRUE)	84" (2,133.6 mm)	100' (30.84 m)
1/2" I.D. Hose	48" (1,219.2 mm)	100' (30.84 m)

Hose larger than 1/2" I.D. may require an external pump.

Vertical rise higher than 84" **will** require external pump.

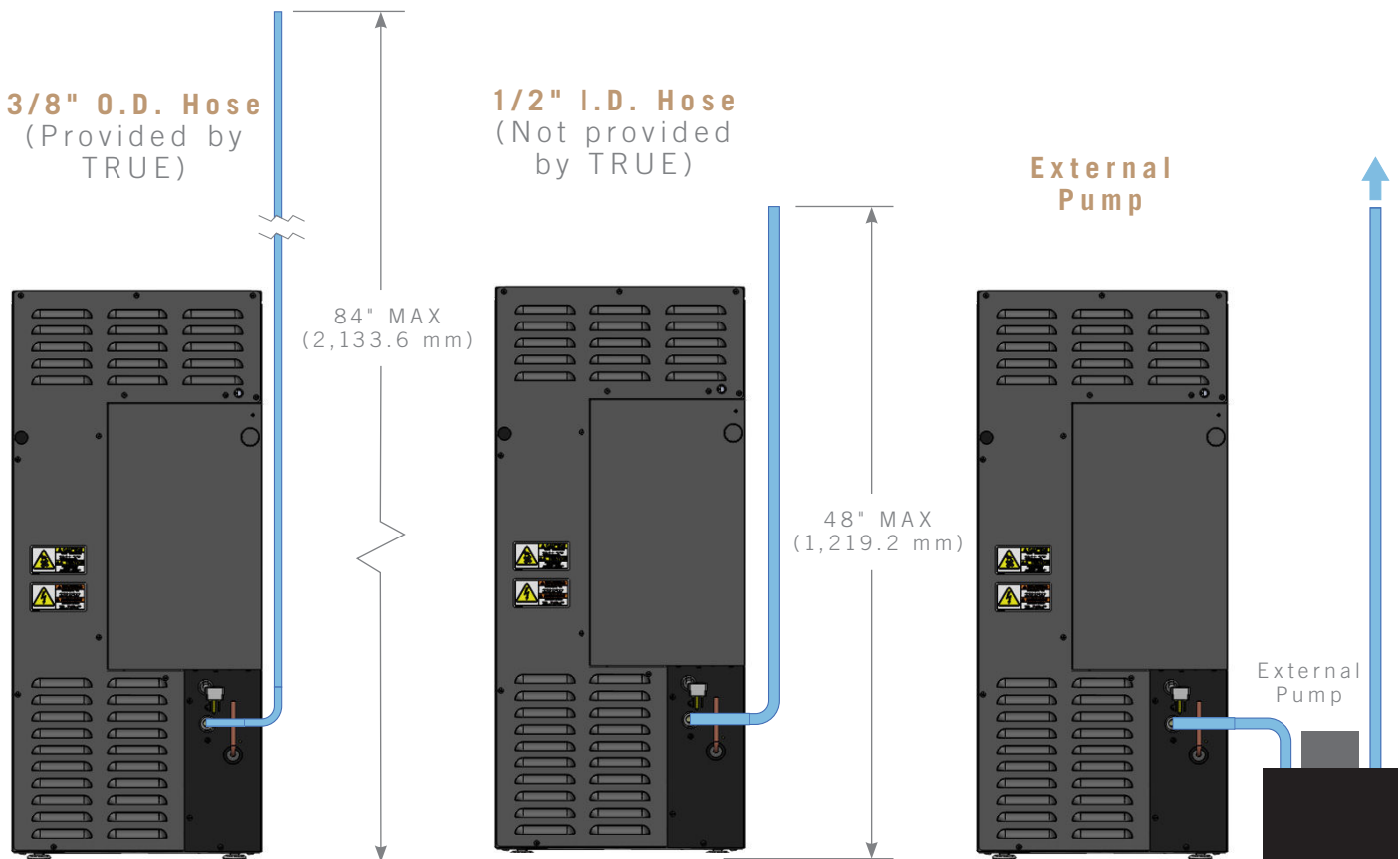

PRIOR TO INSTALLATION

WATER SUPPLY



WARNING! ONLY CONNECT YOUR ICE MACHINE TO A POTABLE WATER SUPPLY.

- The ice machine comes with a 1/4" O.D. copper tube for connecting the water supply. See fig. 1. for water inlet location.
- Water pressure must be between 20-80 psig (1.4 - 5.5 bar). If the water pressure exceeds the maximum pressure, install a water pressure regulator.
- A reverse osmosis system can be used if there is **constant water pressure of 20-80 psig (1.4-5.5 bar)**.
- Cold water supply required. Incoming water temperature must remain 40-100°F (4.4-7.8°C).
- Never connect to a hot water supply. Be sure all hot water restrictors installed for other equipment are working, such as check valves on sink faucets, dishwashers, etc.
- Water regulating valve recommended for pressures higher than 80 psig (5.5 bar). If so desired, installing a water hammer valve can reduce the noise and shock from the valve closing.
- Use tight-fitting, leak-proof permanent connections for the water supply. Soldered connections are always best. In the absence of soldering, use compression-type fittings for more reliability.
- While push fittings are acceptable, they are prone to leaks when installed incorrectly and/or not according to the manufacturer's specifications.
- TRUE recommends coiling extra length of supply hose behind the machine to allow proper servicing of the unit. See fig. 1.
- Connect the water supply line to the house supply with an easily accessible shut-off valve in your installation. See fig. 1.
- Insulate the supply line to prevent condensation.
- When switching to PEX, the tubing must be rated for 150 psi (10.3 bar) burst pressure minimum and 180°F (82.2°C).

	Water Temperature	Water Pressure
Minimum	40°F (4.4°C)	20 psig (1.4 bar)
Maximum	100°F (37.8°C)	80 psig (5.5 bar)

Plumbing Material	
Water Supply	1/4" O.D. copper braided stainless steel PEX tubing and compression fittings (1/4" lines and fittings not provided by TRUE)
Drain Connection	1/2" O.D. Female NPT Fitting (see fig. 1.)

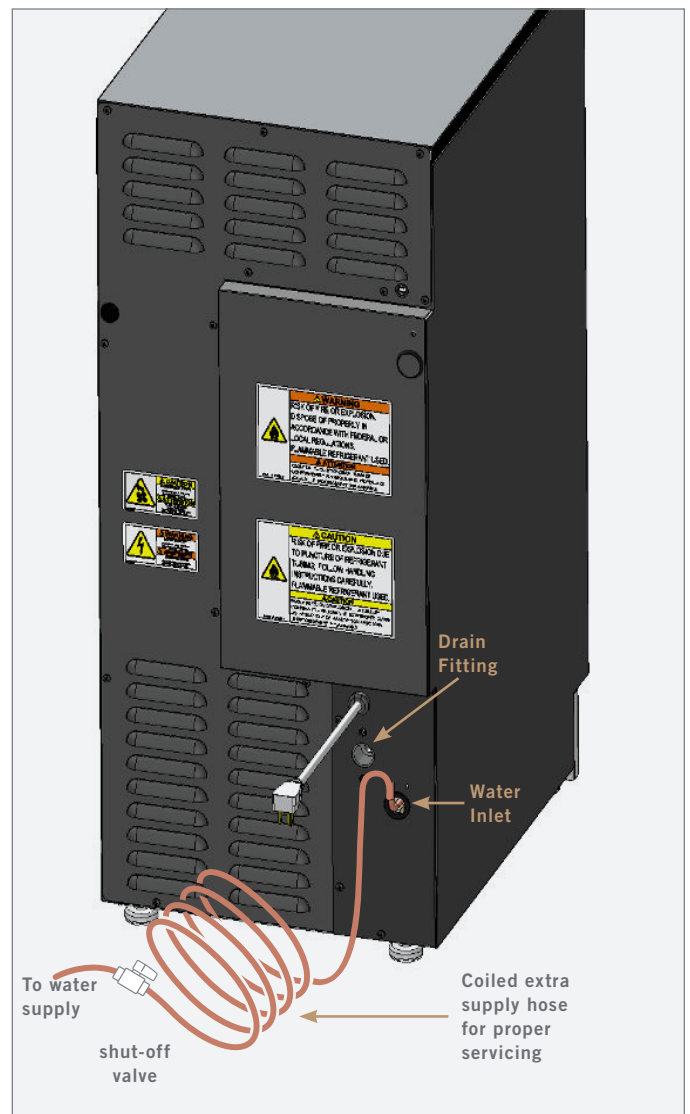

FIG. 1. Example of a water supply installation. Your application may differ.

NOTES

INSTALLATION

UNCRATING

LEVELING LEGS

LEVELING

KICKPLATE INSTALLATION

WATER FILTER INSTALLATION



PRESERVE THE MOMENT®

UNCRATING

REQUIRED TOOLS

- Cutting Tool
- Hammer
- Crowbar
- Phillips Screwdriver
- Floor Protector

PROCEDURE

The following procedure is recommended for uncrating the unit:

1. Remove the outer packaging (cardboard and clear plastic). See fig. 1.
2. Inspect the unit for concealed damage.
Immediately file a claim with the freight carrier if there is damage.
3. Cut the plastic band and remove the foam block. See fig. 2.

NOTE: MOVE THE UNIT AS CLOSE AS POSSIBLE TO ITS FINAL LOCATION BEFORE REMOVING THE SKID.

4. Position the floor protector next to the skid.
5. Carefully lift the unit off the skid and place the unit on the floor protector. See fig. 3.
6. Remove the interior packaging.



FIG. 1. Pull the staples from the skid.

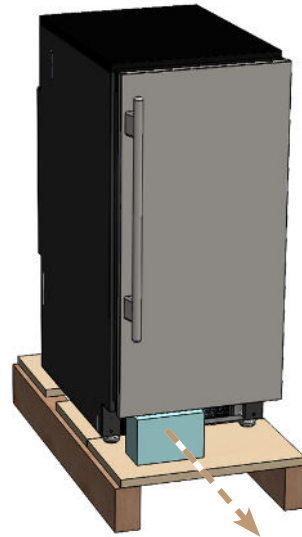

FIG. 2. Remove the foam block after moving the unit as close as possible to the final installation location.

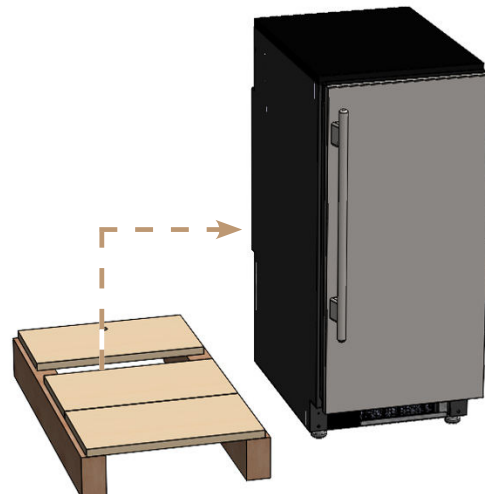

FIG. 3. Carefully move the unit off the skid.

INSTALLATION

LEVELING LEGS

PROCEDURE

With access to the bottom of the appliance, turn the leveling legs to adjust the level as needed. See figs. 1 and 2.

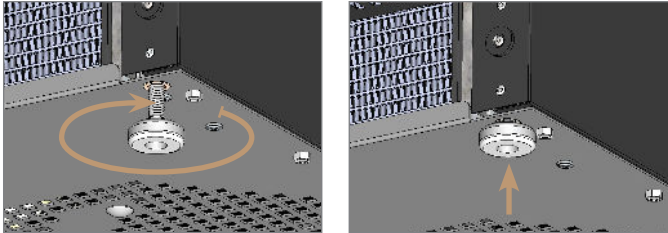

FIG. 1. Turn the leveling legs clockwise to lower the unit.

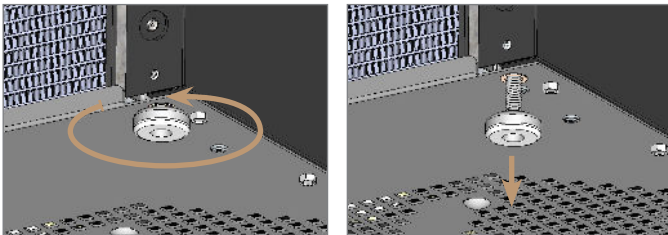

FIG. 2. Turn the leveling legs counterclockwise to raise the unit.

LEVELING

Proper leveling of your ice machine is critical to operating success. Leveling effects drainage and door operation.

PROCEDURE

1. Set the unit in its final location. Be sure there is adequate ventilation in your room.
2. Verify the unit's level. On the unit's top, check the level front-to-back and side-to-side. See fig. 1.
3. Turn the leveling legs as needed to adjust the level. See "Leveling Legs" (pg. 31).

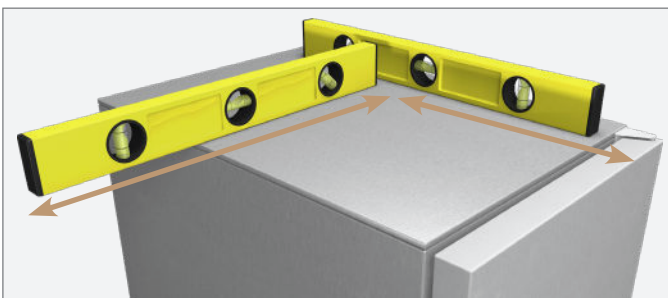

FIG. 1. Check the level from the top of the unit.

KICKPLATE INSTALLATION

The kickplate is shipped unattached to the unit to allow easy access for levelling. The kickplate attaches to the unit with magnets at the bottom of the unit.

INSTALLATION

1. After leveling the unit, position the kickplate below the door. See figs. 1 and 2.
2. Verify the kickplate is correctly aligned. Adjust as needed.

REMOVAL

Pull the kickplate away from the unit.

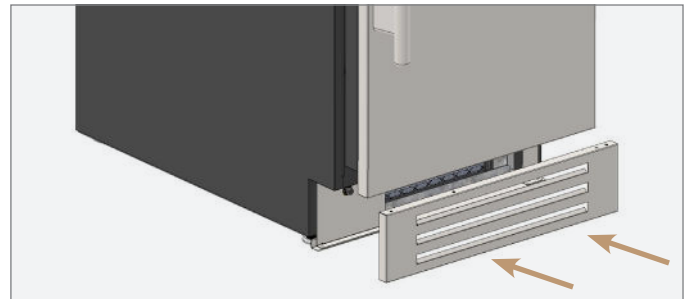

FIG. 1. Attach the kickplate to the magnets below the door.

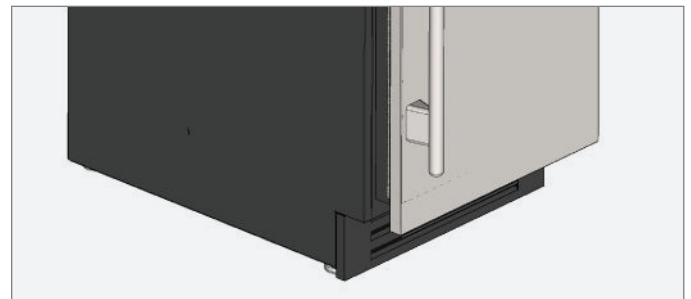

FIG. 2. Adjust the kickplate as needed.

WATER FILTER INSTALLATION

The built-in water filter removes any unpleasant taste/odor, as well as inhibiting scale. The filter life expectancy is 12 months for low-scale water and 6 months for high-scale water. The ice machine monitors how long the filter has been in operation; the display will show **rtr** and the water droplet icon will flash when the filter needs to be replaced. See "Water Filter Relacement" (pg. 47).



CAUTION! Install the water filter before turning on the water supply to the machine. **DO NOT** install the water filter while the water supply is pressurized.

ALWAYS relieve the water pressure before changing the filter.



NOTICE: DO NOT ALLOW THE ICE MACHINE TO BE EXPOSED TO TEMPERATURES BELOW 32°F (0°C) WITHOUT WINTERIZING THE MACHINE AS THIS WILL CAUSE ANY WATER IN THE MACHINE TO FREEZE. FAILURES CAUSED BY EXPOSURE TO FREEZING TEMPERATURES ARE NOT COVERED BY THE WARRANTY.

To order a replacement water filter, go to <https://store.trueresidential.com/collections/maintenance-1/products/replacement-water-filter> or contact our parts department at **844-849-6226** or TrueResidentialParts@TrueMfg.com.

INSTALLATION

1. Align the filter with the filter head's teeth inside the machine. See fig. 1.
2. Insert the water filter and rotate the water filter clockwise. See figs. 2 and 3.

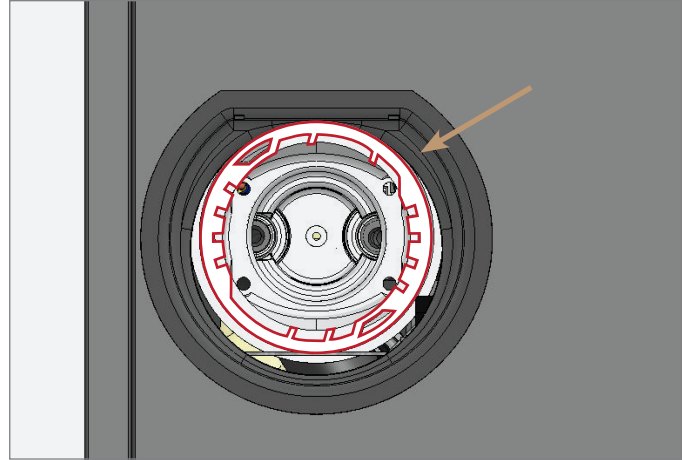

FIG. 1. Teeth inside the filter head.

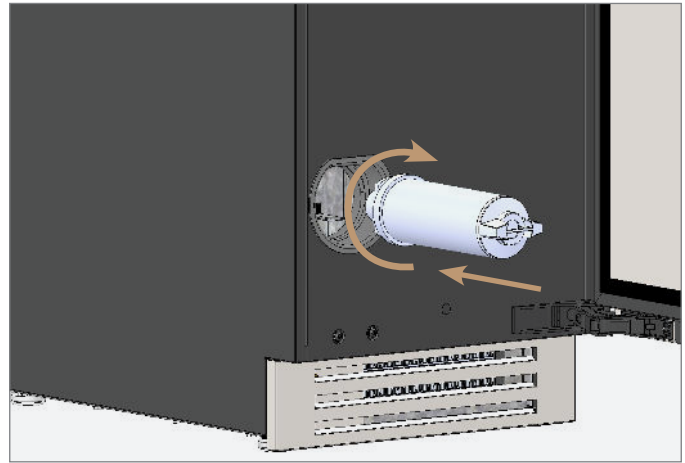

FIG. 2. Insert the water filter and rotate it clockwise.

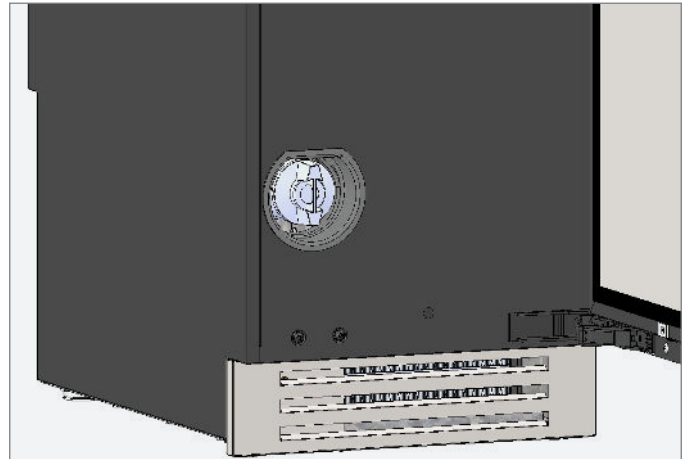

FIG. 3. Installed water filter.

ICE SCOOP

90° DOORSTOP INSTALLATION (OPTIONAL ACCESSORY)



PRESERVE THE MOMENT®

ICE SCOOP

For easy storage, position the ice scoop on the door's interior. See fig. 1.

1. Orient the door as desired. See "Reversing Door". (pg. 60).
2. Locate the ice scoop in the interior packaging.
3. Position the ice scoop on the door's interior. See fig. 1.

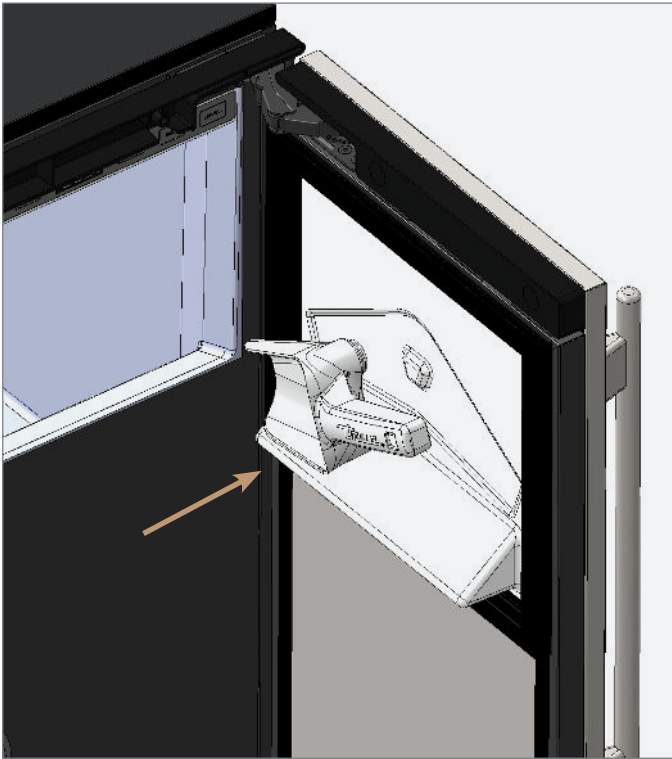

FIG. 1. Attach the ice scoop to the door.

90° DOORSTOP INSTALLATION (OPTIONAL ACCESSORY)

The doorstop restricts the door from opening past approximately 90° to prevent damage to surrounding cabinets.

NOTE: BE SURE TO PUT A DOORSTOP PIN IN BOTH THE TOP AND BOTTOM HINGES. SEE FIGS. 1 AND 2.

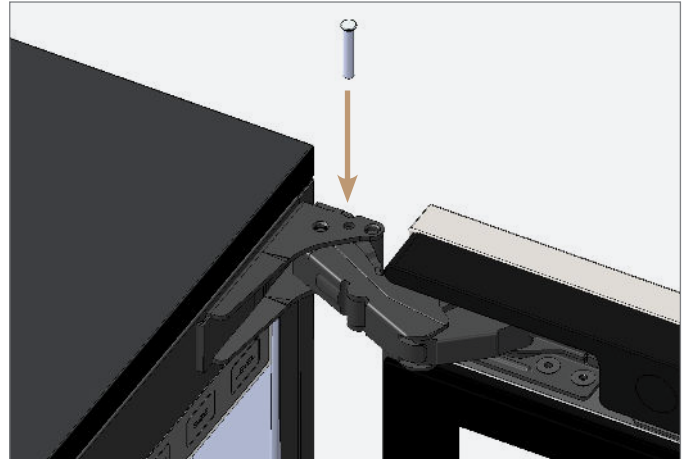

FIG. 1. Drop the doorstop pin into the articulated hinge.

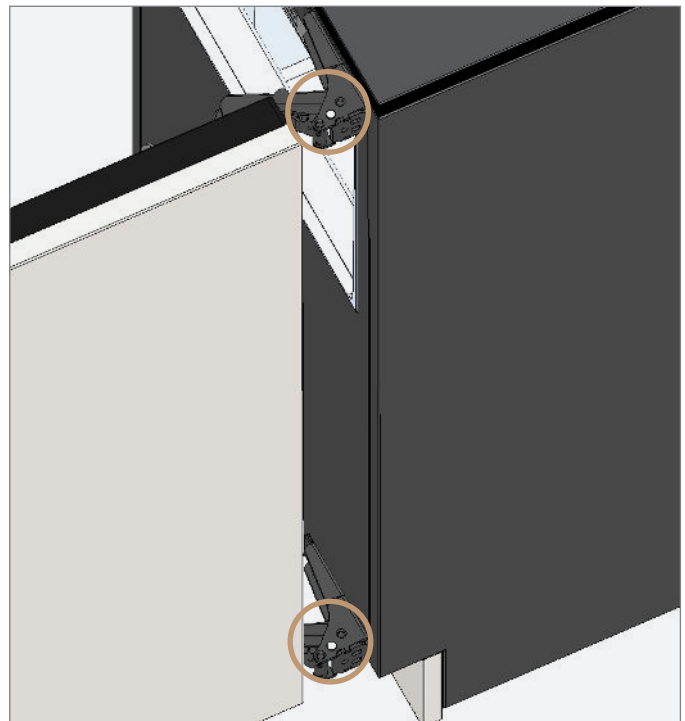

FIG. 2. Install a doorstop pin in both hinges.

BEFORE OPERATING

BREAKER RESET

POWER SEQUENCE

ICE MAKING SEQUENCE

ELECTRONIC CONTROL OPERATION



PRESERVE THE MOMENT®

BEFORE OPERATING

To ensure ice quality, please clean and sanitize this machine prior to first use. See “Descaling & Sanitizing” (pg. 49). To ensure proper operation, follow the installation checklist at the front of this manual.

NOTE: COSTS ASSOCIATED WITH ADJUSTMENTS, CLEANING AND SANITIZING PROCEDURES IN THIS GUIDE ARE NOT COVERED BY THE WARRANTY.



WARNING! DO NOT USE THE ICE MACHINE TO STORE ANYTHING OTHER THAN ICE.

WARNING! DO NOT OPERATE EQUIPMENT THAT HAS BEEN MISUSED, NEGLECTED, DAMAGED, ALTERED OR MODIFIED IN ANY WAY.

BREAKER RESET

The breaker switch is located behind the kickplate (see fig. 1). If the unit trips, press the breaker to reset the switch.

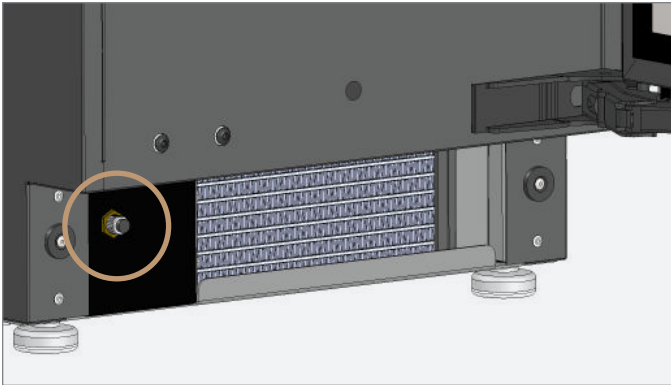



FIG. 1. Breaker switch location.

POWER SEQUENCE

- Press the power button  once to begin ice making operation. Press the button a second time to turn the ice machine off.
- When unit is plugged in, the control board goes through a sequence of checks to verify all sensors are working properly.
- The drain system is energized when power is supplied to the unit. It automatically turns on when it senses water in the drain tube.
- Display will show **oFF** until the power button is pressed.
- If the unit powers the drain pump but the drain remains clogged for five min., the display will show **drn** and cut power to the unit.
- If unit is too cold / too hot, or if the temperature probe is unplugged / failed, the unit shuts down and displays an error message.

ICE MAKING SEQUENCE

Your TRUE Ice® machine will produce one batch of ice (24 cubes) approximately every 20 min. The following steps occur during ice making:

INITIAL FILL / INITIAL HARVEST

The ice machine always begins in Fill mode. During Fill or Harvest modes—

- The display will read **FiL** (Fill mode) or **hAr** (Harvest mode).
- The reservoir fills with water (for 2–3 min.)
- Excess / residual water drains.
- Any residual ice cubes from a previous cycle are melted free from the evaporator by warming the evaporator with a warm refrigerant (Harvest mode).

ICE MAKING

When making ice:

- The display will read **ICE**
- Water sprays into the inverted ice cups as the evaporator cools, forming ultra-clear ice cubes in each cup
- The compressor, condenser fan motor, and water pump operate.
- As ice is produced on the evaporator, the reservoir's water level will lower.
- Adjusting the ice cube size alters the water level needed for completing the cycle.
- The ice making cycle ends when
 - The reservoir's water level has dropped to a sufficient level based on the ice cube size setting AND
 - When the t1 evaporator probe detects the minimum temperature threshold.

ICE HARVEST

When harvesting ice:

- The display will read **hAr**
- The compressor remains on, but the condenser fan motor and pump turn off. The hot gas bypass and water valves open.
- As the evaporator warms, ice cubes begin to fall into the ice bin.
- The reservoir refills with water and overflows to flush impurities down to the drain pump.
- The harvest cycle ends when the evaporator reaches 47°F (8.3°C) and then a completion timer expires.
- All 24 ice cubes should fall into the ice storage bin before the next ice making cycle begins.

FULL BIN

When the ice bin is full:

- The display will read **FUL**
- The ice machine shuts off automatically when the ice level sensor determines the amount of ice has reached the set level (see "Adjust Ice Level", pg. 39).
- The condenser fan will turn on in reverse to clean the condenser; this removes any built-up dust or debris, which prolongs the time needed between full condenser coil cleanings.
- The drain pump will periodically run to remove any residual water in the bin from melted ice cubes.
- The ice machine turns back on when the ice level sensor determines the amount of ice has decreased to below the set level (see "Adjust Ice Level", pg. 39).

APPLIANCE OPERATION

ELECTRONIC CONTROL OPERATION

ELECTRONIC CONTROL LEGEND



A. Menu / Enter

B. Toggles Power/Standby

C. Toggles Bin Light Colors/
Scroll Down (In Menu
Mode)

D. Display

E. Initiate Automatic Clean/
Scroll Up (In Menu Mode)

F. Adjust Cube Size

G. Adjust Bin Ice Level

 Water Filter Reminder

 Cleaning Reminder

 Air Filter Reminder

APPLIANCE OPERATION

ELECTRONIC DISPLAY CODES

Display	Description	Action Needed
	Appliance is off – some components still have power	Press and hold POWER  for 3 sec. to turn the appliance on.
	Fill mode – reservoir fills with water	Normal operation; no action.
	Harvest mode – clears ice (or residual ice) from the ice mold in the storage bin	Normal operation; no action.
	Ice mode – making ice	Normal operation; no action.
	Full Mode – ice storage bin is full and unit is in standby	Normal operation; no action.
 or 	Cleaning reminder	Descal / sanitize appliance – reminder will reset after completed cleaning cycle.
 or 	Condenser coil cleaning reminder	Clean condenser coil (see pg. 48) – hold LIGHT + CLEAN to reset reminder.
 or 	Water filter reminder	Replace water filter (see pg. 47) – hold LIGHT + CLEAN to reset reminder.
	Drain error – appliance not able to drain in 5 min. of operation	Check drain line for kinks and clogs.
	Long fill – appliance unable to fill reservoir within allotted time	Verify water filter is installed and water supply is turned on.
	Long Ice – extended freeze time	Press POWER  twice to reset the machine – if error code persists, contact a service company.
	Temperature thermistor 1 failure	Contact a service company.
	Temperature thermistor 2 failure	Contact a service company.
	Hot gas valve failure	Contact a service company.
	Evaporator thermistor fell below 14° F (-10° C) within first 5 min. of freeze time	Verify water pump sprays and spray nozzles are not clogged.
	Refrigerator pressure too high	Clean condenser coil (see pg. 48) – press POWER  twice to reset the machine – if error code persists, contact a service company.
	Ambient temperature too cold	Wait for ambient temperature to rise – winterize the appliance to prevent damage (see pg. 58).

DRAIN TIME ALARM

If the drain does not clear within 5 min. of running, the display will show **drn Err** to signal a clogged / kinked drain line or a drain pump failure. The control automatically shut off the water supply. If a clogged drain clears, the display will show **drn** and **OFF**.



CAUTION! ADHERE TO LOCAL AND STATE PLUMBING CODES. DO NOT EXCEED THE MAXIMUM PLUMBING HEIGHTS FOR THE GIVEN SETUP.

SEE "DRAIN CONNECTION" (PG. 24). THE DRAIN ALARM IS INITIATED BY THE CONTROL BOARD IN THE EVENT OF IMPROPER DRAINAGE.

NOTE: VERIFY THE ICE MACHINE DRAINS THROUGH TWO CYCLES WITHOUT ANY ALARM DURING INSTALLATION.

MAINTENANCE REMINDERS

Your ice machine will remind you when to perform the automatic clean, when to clean condenser coil, and when to replace your water filter.



Water Filter Reminder (flashing)



Cleaning Reminder (flashing)



Condenser Cleaning Reminder (flashing)

CONDENSER CLEANING REMINDER

Days elapsed since last condenser coil cleaning.



WATER FILTER REMINDER

Days elapsed since last water filter replacement.



AUTOMATIC CLEANING REMINDER

Days elapsed since last performed automatic cleaning.



RESET REMINDERS

Press both **LIGHT** and **CLEAN**.

NOTE: RESETTING THE REMINDERS RESETS BOTH THE CONDENSER CLEANING AND THE WATER FILTER REPLACEMENT REMINDERS.

NOTE: THE AUTOMATIC CLEAN REMINDER CAN ONLY BE RESET BY COMPLETING THE AUTOMATIC CLEANING CYCLE.

BIN LIGHT



Press **LIGHT** to control the bin light.

- Press **LIGHT** repeatedly to cycle through the 14 preset designer light colors
- Press and hold **LIGHT** for 5 sec. to toggle the bin light on or off.

ADJUST CUBE SIZE

The ice cube size is easily adjustable to meet your usage.

The available cube sizes range from -6 (smallest) to +6 (largest). The default is 0.

To adjust the cube size, press **SIZE** until the display shows the desired setting.

ADJUST ICE LEVEL

The ice bin level determines how much ice will be in the storage bin before the ice level sensor considers full. The default setting is 100%. the level adjusts in 5% increments.

To adjust the ice level, press **LEVEL** until the display shows the desired setting.

ADJUST FOR WATER QUALITY

The water quality setting allows your ice machine to easily accommodate different levels of water quality / hardness / scale. The available settings range from 0 (soft water / low scale) to 5 (hard water / high scale). The default setting is 0. Please see fig. 1.

If you are unsure of your water quality, check your water with a water quality test kit (not provided by TRUE).

To adjust for water quality, press both **LIGHT** and **SIZE**.

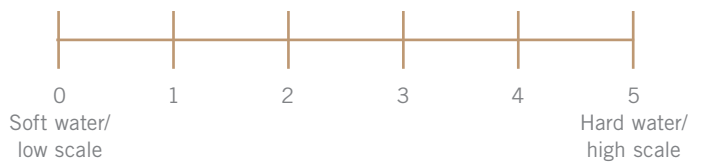











FIG. 1. Water quality setting range.

APPLIANCE OPERATION

COMMANDS AND KEY COMBINATIONS

















See the table below for commands and their corresponding key combinations.

Command	Key Combination	Display Code	Detailed Description
Power unit on / off	 Press and hold POWER button for 3 sec.		Turns the unit on and off.
Adjust ice level	 Press LEVEL until the display shows the desired setting		Digitally adjust your "full" ice level. The ice storage bin will be considered full at that value. Default 100%.
Change light color	 Press LIGHT .		Switch between the 14 LED colors.
Adjust cube size	 Press SIZE until the display shows the desired setting.		Adjusts cube size in increments from 1 to 6 for larger cubes, then -6 to -1 for smaller cubes. Ice size default is 0.
Clean Mode	 Press and hold CLEAN for 3 sec.		Press and hold CLEAN for 3 sec. to begin the automatic cycle. Follow the prompts to select the settings and start the cycle.
Adjust for water quality	 +  Press both LIGHT and SIZE		Soft water / low scale setting is 0. Hard water / high scale setting is 5. Adjusting the value higher flushes more water between cycles, resulting in clearer ice cubes.

APPLIANCE OPERATION

COMMANDS AND KEY COMBINATIONS (CONT.)

See the table below for commands and their corresponding key combinations.

Command	Key Combination	Display Code	Detailed Description
Reset Maintenance Reminders	 +  Press both LIGHT and CLEAN .		Resets the condenser cleaning and water filter replacement reminders. Both are reset when pressed. See "Maintenance Reminders" (pg. 46).
Circulate Pump Motor	 Press CLEAN twice (2x).		In Standby: Circulates the Pump motor (on / off).
Initiate Manual Drain Pump Operation	 +  Press and hold both CLEAN and SIZE .	N/A	Bypasses the background operations and runs the drain pump only while buttons are held .
Initiate Manual Fill	 Press CLEAN 3 times (3x).		In Standby: Starts a Manual Fill Routine.
Initiate Manual Harvest	 +  Press and hold both POWER and CLEAN for 3 sec.		In Standby of Freeze: Starts a Manual Harvest Cycle.
Initiate Reverse Condenser Cleaning	 +  Press and hold POWER and SIZE for 3 sec.		In Standby: Starts a Reverse Condenser Cleaning.
Clear The Alarm History	 Press POWER twice (2x).	N/A	Removes any alarms from the machine's memory.

GENERAL MAINTENANCE

WATER FILTER REPLACEMENT

CONDENSER COIL CLEANING

APPLIANCE CARE AND CLEANING

DESCALING & SANITIZING

INTERIOR COMPONENTS

WINTERIZING



PRESERVE THE MOMENT®

GENERAL MAINTENANCE, CARE & CLEANING

GENERAL MAINTENANCE

You are responsible for maintaining the ice machine in accordance with the instructions in this manual. Maintenance procedures are not covered by warranty.

True recommends performing the following maintenance procedures a minimum of once every six months to ensure reliable, trouble-free operation.



WARNING! IF YOU DO NOT UNDERSTAND THE NECESSARY PROCEDURES OR SAFETY PRECAUTIONS, CALL YOUR LOCAL TRUE SERVICE REPRESENTATIVE TO PERFORM MAINTENANCE PROCEDURES FOR YOU.



WARNING! TAKE CARE DURING OPERATION, MAINTENANCE, OR REPAIRS TO AVOID CUTS OR PINCHING FROM ANY APPLIANCE PART/COMPONENT.

EXTERIOR CLEANING

Clean the exterior as needed. Follow stainless steel cleaning recommendations (pg. 49) to ensure your machine always looks like new.

DESCALING & SANITIZING

Descale and sanitize every 6 months. See "Descaling & Sanitizing" (pg. 51).

WATER FILTER REPLACEMENT

Replace the water filter at least once every 12 months. More frequent replacement may be required based on your water quality. See "Water Filter Replacement" (pg. 47)

CONDENSER COIL CLEANING

For optimum operation, clean your condenser coil every 6 months. See "Condenser Coil Cleaning" (pg. 48).

Maintenance	Weekly	Semi-Annual	Annual	After Prolonged Shutdown	At Start-Up
Clean Appliance Exterior	X			X	X
Sanitize Ice Machine		X	X	X	X
Descale Ice Machine		X	X	X	X
Clean Condenser Coil		X	X	X	
Change The Water Filter		X	X	X	
Check Ice Quality	X	X	X	X	X

WATER FILTER REPLACEMENT

To order a replacement water filter, go to: <https://store.trueresidential.com/collections/maintenance-1/products/replacement-water-filter> or contact our parts department at: **844-849-6226** or **TrueResidentialParts@TrueMfg.com**.

NOTE: BE SURE TO RESET THE WATER FILTER REPLACEMENT REMINDER AFTER REPLACING THE WATER FILTER. SEE "MAINTENANCE REMINDERS" (PG. 46).



CAUTION! DO NOT install the water filter while the water supply is pressurized. **ALWAYS** relieve the water pressure before changing

the filter.

1. Relieve the water pressure.
2. Rotate the water filter counterclockwise and pull the filter from the unit. See fig. 1.
3. Insert the replacement water filter and rotate the filter clockwise. See fig. 2.

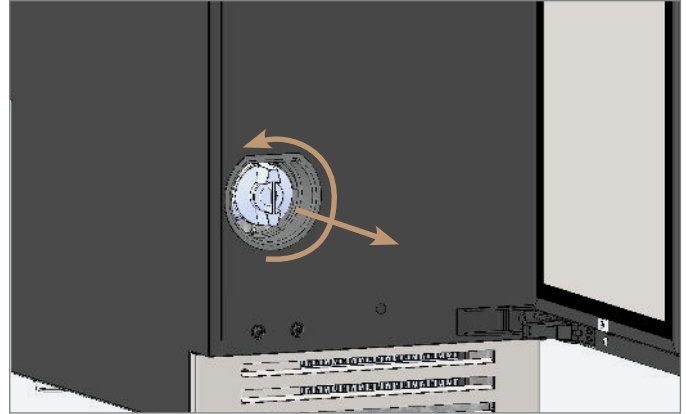

FIG. 1. Rotate the existing water filter counterclockwise.

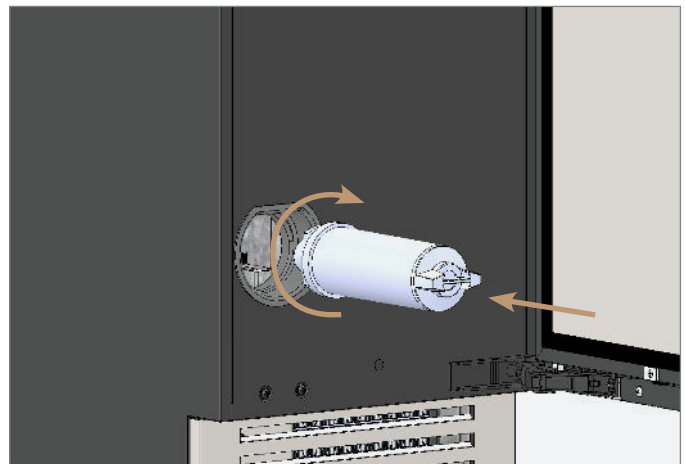

FIG. 2. Insert the replacement water filter and rotate it clockwise.

CONDENSER COIL CLEANING

Keeping the condenser coil clean minimizes required servicing and lowers electrical cost. Warranty does not cover cleaning the condenser coil.

NOTE: BE SURE TO RESET THE CONDENSER COIL CLEANING REMINDER AFTER CLEANING THE CONDENSER COIL. SEE "MAINTENANCE REMINDERS" (PG. 40).



WARNING! Electrical shock or burn hazard. Unplug the unit or turn off the power supply before proceeding. **DO NOT** clean appliance with a pressure washer or hose.



CAUTION! Risk of eye injury from debris. Eye protection is recommended.



CAUTION! Coil fins are sharp. Gloves are recommended.

REQUIRED TOOLS

Required tools include (but may not be limited to) the following.

- Gloves
- Eye Protection
- Stiff Bristle Brush
- Vacuum Cleaner
- Flashlight
- Tank of Compressed Air

CLEANING STEPS

1. Remove the kickplate. See fig. 1.
2. With a stiff bristle brush, carefully clean accumulated dirt from the front coil fins.
3. With the dirt removed from the surface of the coil, use a flashlight to verify you can see through the coil. See fig. 3.
4. If the view is clear, reinstall the kickplate, restore power, and verify correct operation.
5. If the view is not clear, gently blow compressed air or CO₂ through the coil until it is clean.
6. Carefully vacuum any dirt around the condensing unit area.
7. Reinstall the kickplate, restore power, and verify correct operation.

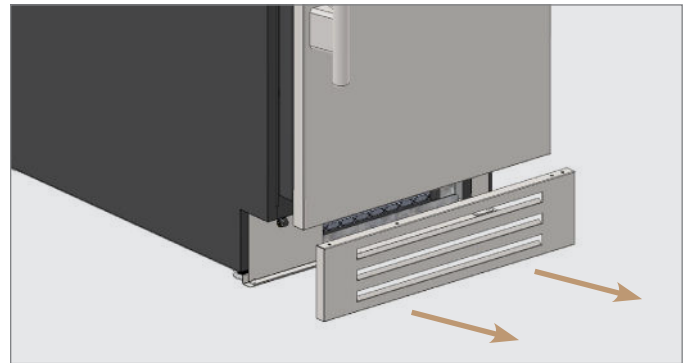

FIG. 1. Pull the kickplate off the magnets.

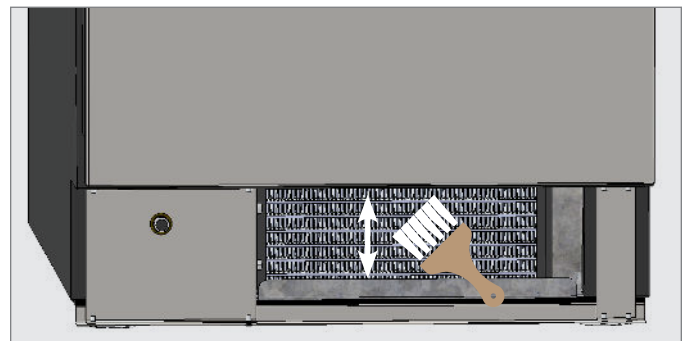

FIG. 2. Never brush across the coil fins.

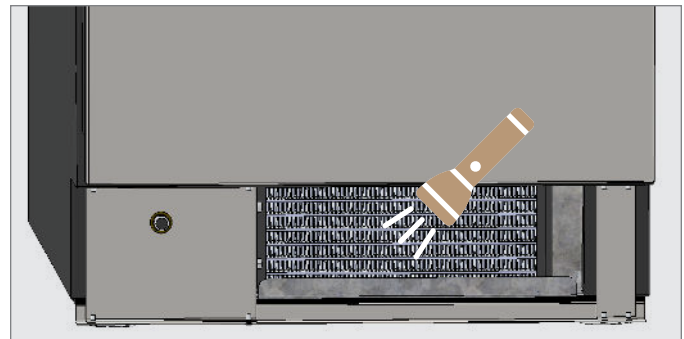

FIG. 3. Verify all blockages have been removed.

APPLIANCE CARE & CLEANING



CAUTION! DO NOT USE ANY STEEL WOOL, ABRASIVE OR CHLORINE BASED PRODUCTS TO CLEAN STAINLESS STEEL SURFACES.

STAINLESS STEEL OPPONENTS

There are three basic things which can break down your stainless steel's passivity layer and allow corrosion to form.

- Scratches from wire brushes, scrapers, and steel pads are just a few examples of items that can be abrasive to stainless steel's surface.
- Deposits left on your stainless steel can leave spots. You may have hard or soft water depending on what part of the country you live in. Hard water can leave spots. Hard water that is heated can leave deposits if left to sit too long. These deposits can cause the passive layer to break down and rust your stainless steel. All deposits left from food prep or service should be removed as soon as possible.
- Chlorides are present in table salt, food, and water. Household and industrial cleaners are the worst type of chlorides to use.

STAINLESS STEEL CLEANING & RESTORATION

Stainless steel cleaners must be free of phosphates, chlorine, chloride, and ammonia.

TRUE offers environmentally-friendly cleaner and polish through our True Store at <https://store.trueresidential.com/products/stainless-steel-clean-polish-kit>

CUSTOM PAINTED APPLIANCES & HARDWARE

For painted doors and other surfaces, use a mild solution of soap and water with a soft microfiber cloth.

APPLIANCE CARE & CLEANING

8 TIPS TO HELP PREVENT RUST ON STAINLESS STEEL

- **Maintain the Cleanliness of Your Equipment** – Avoid build-up of hard stains by cleaning frequently. Use cleaners at the recommended strength (alkaline chlorinated or non-chloride).
- **Use the Correct Cleaning Tools** – Use non-abrasive tools when cleaning your stainless steel products. The stainless steel's passive layer will not be harmed by soft cloths and plastic scouring pads.
- **Clean Along Polishing Lines** – Polishing lines ("grain") are visible on some stainless steels. Always scrub parallel to polishing lines when visible. Use a plastic scouring pad or soft cloth when you cannot see the grain.
- **Use Alkaline, Alkaline-Chlorinated or Non-Chloride Cleaners** – While many traditional cleaners are loaded with chlorides, the industry is providing an ever increasing choice of non-chloride cleaners. If you are not sure of your cleaner's chloride content, contact your cleaner supplier. If they tell you that your present cleaner contains chlorides, ask if they have an alternative. Avoid cleaners containing quaternary salts, as they can attack stainless steel, causing pitting and rusting.
- **Rinse** – When using chlorinated cleaners, you must rinse and wipe dry immediately. It is better to wipe standing cleaning agents and water as soon as possible. Allow the stainless steel equipment to air dry. Oxygen helps maintain the passivity film on stainless steel.
- **Never Use Hydrochloric Acid (Muriatic Acid) on Stainless Steel** – Even diluted, hydrochloric acid can cause corrosion, pitting and stress corrosion cracking of stainless steel.
- **Water Treatment** – To reduce deposits, soften hard water when possible. Installation of certain filters can remove corrosive and distasteful elements. Salts in a properly maintained water softener can also be to your advantage. Contact a treatment specialist if you are not sure of the proper water treatment.
- **Regularly Restore & Passivate Stainless Steel** – Stainless steel gets its stainless properties from the protective chromium oxides on its surface. If these oxides are removed by scouring, or by reaction with harmful chemicals, then the iron in the steel is exposed and can begin to oxidize, or rust. Passivation is a chemical process that removes free iron and other contaminants from the surface of stainless steel, allowing the protective chromium oxides to re-form.

DESCALING & SANITIZING



DANGER! HIGHLY CORROSIVE CLEANING CHEMICALS.



AVOID CONTACT WITH EYES AND SKIN. WEAR EYE PROTECTION AND CHEMICAL-RESISTANT RUBBER GLOVES WHEN HANDLING.



WARNING! TOXIC MATERIAL HAZARD! DO NOT MIX DESCALER WITH SANITIZER. HARMFUL FUMES MAY BE GENERATED.



WARNING! AFTER CLEANING, BEFORE CONSUMING ICE, LET THE ICE MACHINE MAKE ICE FOR ONE (1) HOUR AND DISCARD ALL THE

PRODUCED ICE.



ONLY USE TRUE MANUFACTURING APPROVED ICE MACHINE DESCALER AND SANITIZER TO DESCALE AND SANITIZE YOUR ICE MACHINE.

ANY DAMAGE FROM USING OTHER DESCALER OR SANITIZER WILL NOT BE COVERED UNDER MANUFACTURER'S WARRANTY.

To order TRUE Ice Machine Descaler, go to store.trueresidential.com/collections/maintenance-1/products/ice-machine-descaler or contact our parts department at 844-849-6226 or TrueResidentialParts@TrueMfg.com.

You should fully descale and sanitize your ice machine every six (6) months. Descaling involves removing key ice machine parts, as well as rinsing the parts and the inside of the machine with ice machine descaler.

Sanitizing the ice machine removes potential biological contaminations and molding. For sanitizing only, see "Sanitize" (pg. 54).

NOTE: IF NECESSARY, CANCEL THE CLEANING CYCLE BY SELECTING **non AT THE FIRST SELECTION MENU OR PRESSING AND HOLDING **POWER**  DURING PRECLEAN.**

REQUIRED TOOLS

Required tools include (but may not be limited to) the following:

- Chemical-resistant rubber gloves
- Safety glasses
- Large container (1 gal. capacity minimum)
- TRUE ice machine descaler
- Chlorine Bleach (5.25% sodium hypochlorite solution)
- Measuring spoons
- Soft-bristled brush
- Rags
- Spray bottle (optional)

DESCALE & SANITIZE

1. Press and hold **CLEAN** for three (3) sec. The display will show **des**.
2. Press **LIGHT** and/or **CLEAN** until the display shows **bth**.



3. With the display showing **bth**, press the **TRUE logo**. The display will show **Str**.
4. Press **LIGHT** and/or **CLEAN** until the display shows either **Str** (start) or **Stb** (standby). This determines the ice machine's action upon completion of the cleaning cycle.



5. With the display showing the desired action, press the **TRUE logo**. The selected cleaning cycle will begin.

DESCALE & SANITIZE (CONT.)

- Wait while the display alternates between **PrE** and **CLn** (preclean) for approximately three (3) min.

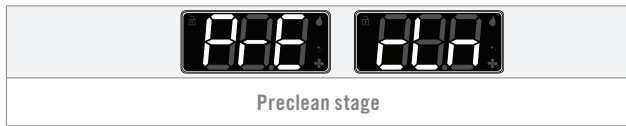

- When the display shows **Add cLn**, pour 6 fl. oz. of undiluted True Ice Machine Descaler into the spray compartment behind the water shutters.



- After adding the descaler, press the **TRUE logo**. The automatic clean cycle will continue; the display will show **cLn**.



- Wait for the rinse and drain cycles to complete.
- When the display shows **rEm Prt** and **Add**, remove the water shutters, ice guide, spray bar, water supply hose, and pump clean-out cap. See “Interior Components” (pg. 55).

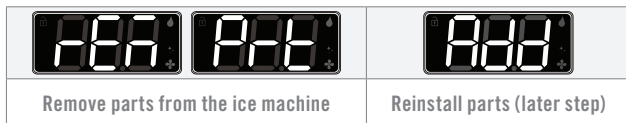

- Mix a descaling solution of 10 fl. oz. undiluted TRUE Ice Machine Descaler and 1 gal. of water.
NOTE: ALWAYS ADD THE CLEANING CHEMICALS TO THE WATER; NEVER ADD WATER TO THE CLEANING CHEMICALS.
- With approximately half the descaling solution, soak the removed parts in the descaling solution for 10-15 min.
- With the remaining descaling solution, descale the ice storage bin, door’s interior, door gasket, and spray compartment.

NOTE: TAKE CARE TO AVOID SPLASHING OR SPILLING THE DESCALING SOLUTION ONTO THE MACHINE’S EXTERIOR OR SURROUNDINGS.

- After letting the components soak, brush off any built-up scale.
- Rinse all descaled parts and areas with clean water.
- Discard remaining descaling solution.
- Reinstall the descaled interior components. See “Interior Components” (pg. 55). Press the **TRUE logo** to advance the clean cycle. The display will show **cLn**.



- Wait for the rinse and drain cycles to complete.
- When the display shows **Add SAn**, pour 2 tsp chlorine bleach (5.25% hypochlorite solution) into the spray compartment behind the water shutters.



- Press the **TRUE logo**. The automatic clean cycle will continue.



- Mix 1.5 fl. oz. (3 tbsp) of chlorine bleach (5.25% hypochlorite solution) with 1 gal. of warm water.
- Sanitize the ice scoop, interior surfaces of the ice machine, the ice storage bin, and the door’s interior. **DO NOT** rinse the sanitized areas.
NOTE: TRUE RECOMMENDS USING A SPRAY BOTTLE FOR HARD-TO-REACH AREAS.
- Pour the remaining sanitizing solution into the ice storage bin. This will sanitize the drain system.
- Wait for the sanitizing cycle to finish. Rinse and dry any exterior areas where cleaning solutions may have spilled.
- After the automatic clean cycle is complete, discard the ice the ice machine has produced in one (1) hour.

DESCALE

1. Press and hold **CLEAN** for three (3) sec.
The display will show **dES**.



2. Press **LIGHT** and/or **CLEAN** until the display shows **dES**.
3. With the display showing **dES**, press the **TRUE logo**
The display will show **Str**.
4. Press **LIGHT** and/or **CLEAN** until the display shows either **Str** (start) or **Stb** (standby). This determines the ice machine's action upon completion of the cleaning cycle.



5. With the display showing the desired action, press the **TRUE logo**. The selected cleaning cycle will begin.
6. Wait while the display alternates between **PrE** and **CLn** (preclean) for approximately three (3) min.

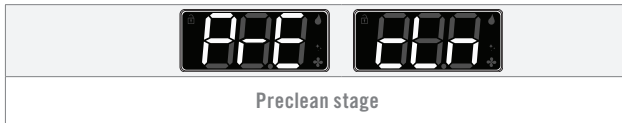

7. When the display shows **Add cLn**, pour 6 fl. oz. of undiluted True Ice Machine Descaler into the spray compartment behind the water shutters.



8. After adding the descaler, press the **TRUE logo**. The automatic clean cycle will continue; the display will show **cLn**.



9. Wait for the rinse and drain cycles to complete.
10. After the automatic clean cycle is complete, discard the ice the ice machine has produced in one (1) hour.

SANITIZE

1. Press and hold **CLEAN** for three (3) sec. The display will show **dES**.
2. Press **LIGHT** and/or **CLEAN** until the display shows **SAn**.

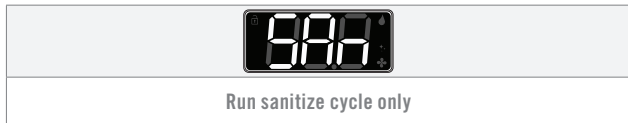

3. With the display showing **SAn**, press the **TRUE logo**. The display will show **Str**.
4. Press **LIGHT** and/or **CLEAN** until the display shows either **Str** (start) or **Stb** (standby). This determines the ice machine's action upon completion of the cleaning cycle.



5. With the display showing the desired action, press the **TRUE logo**. The selected cleaning cycle will begin.
6. Wait while the display alternates between **PrE** and **CLn** (preclean) for approximately three (3) min.



7. Wait for the rinse and drain cycles to complete.
8. When the display shows **Add SAn**, pour 2 tsp chlorine bleach (5.25% hypochlorite solution) into the spray compartment behind the water shutters.



9. Press the **TRUE logo**. The automatic clean cycle will continue.



10. Mix 1.5 fl. oz. (3 tbs) of chlorine bleach (5.25% hypochlorite solution) with 1 gal. of warm water.
11. Sanitize the ice scoop, interior surfaces of the ice machine, the ice storage bin, and the door's interior. **DO NOT** rinse the sanitized areas.
NOTE: TRUE RECOMMENDS USING A SPRAY BOTTLE FOR HARD-TO-REACH AREAS.
12. Pour the remaining sanitizing solution into the ice storage bin. This will sanitize the drain system.
13. Wait for the sanitizing cycle to finish. Rinse and dry any exterior areas where cleaning solutions may have spilled.
14. After the automatic clean cycle is complete, discard the ice the ice machine has produced in one (1) hour.

INTERIOR COMPONENTS

See the following for the removal and correct installation of the interior components.

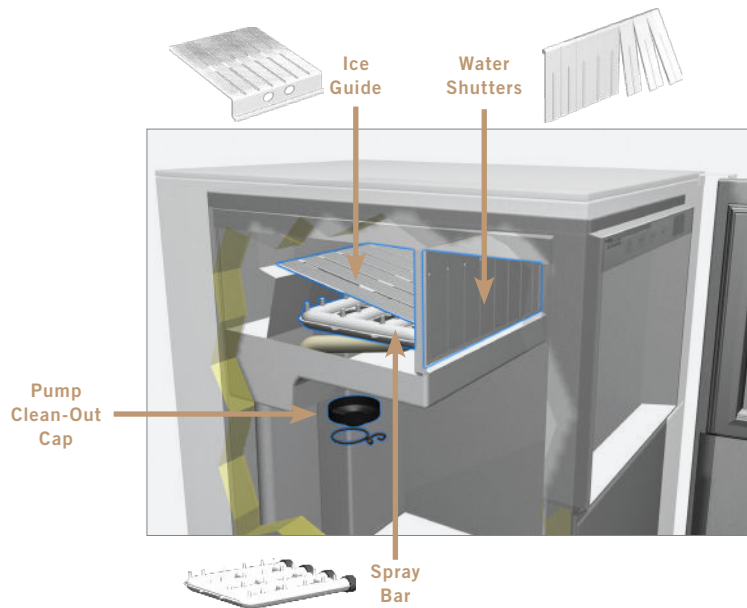
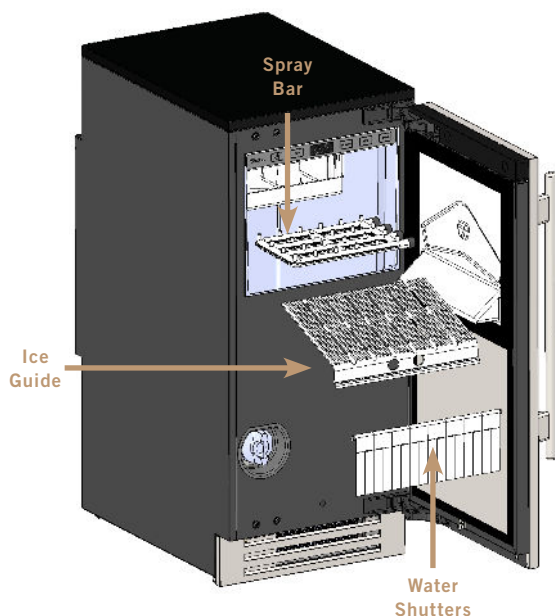

WATER SHUTTER

The water shutter hangs in front of the spray bar and ice guide. It prevents spraying water from escaping the evaporator compartment.

REMOVAL

Lift the shutter rod's ends from the recesses in the sidewall.

INSTALLATION

Insert the shutter rod's ends into the recesses in the sidewall. To be correctly installed, the water shutter must—

- Hang from a shutter rod fully seated in the recessed end supports.
- Conceal the ice guide finger holes.



CORRECT. Ice guide finger holes are hidden; ice guide slotted holes are visible.



INCORRECT. Ice guide finger holes are visible.

ICE GUIDE

The ice guide sits over the spray nozzles and directs falling ice into the bin.

REMOVAL

Lift the front of the guide and pull the guide forward.

INSTALLATION

Position the ice guide over the spray bar. To be correctly installed, the ice guide must–

- Be firmly positioned over the spray bar.
- Sit with its front edge inside the water trough.
- Have its slots aligned with the spray nozzles.



CORRECT. Ice guide positioned in the guide channel and flush against the back side of the water trough opening.



INCORRECT. Ice guide positioned too far inside the water trough.

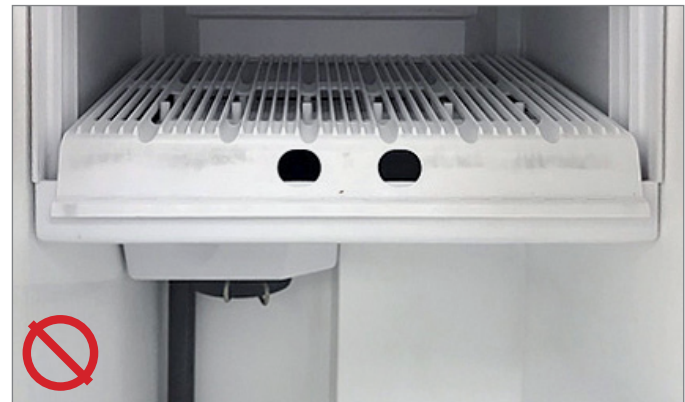

INCORRECT. Ice guide positioned outside the water trough.

SPRAY BAR

REMOVAL

Carefully pull the spray bar from the water supply hose.

INSTALLATION

The spray bar, located in the water trough, supplies water to the individual ice cube cups. To be correctly installed, the spray bar must–

- Be positioned with the clean-out caps on the right.
- Sit fully seated and horizontally level.



CORRECT. Spray bar is fully seated, level, and positioned with the clean-out caps on the right..

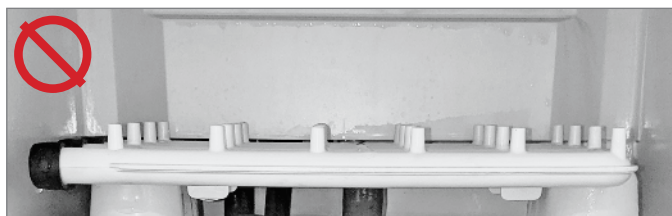

INCORRECT. Spray bar positioned with clean-out caps on the left.



INCORRECT. Spray bar is not fully seated or level.

PUMP CLEAN-OUT CAP

REMOVAL

1. Remove the pump clamp. See fig. 1.
2. Pull the clean-out cap down.

INSTALLATION

1. Slide the clean-out cap over the hole beneath the pump.
2. Reinstall the pump cap clamp.

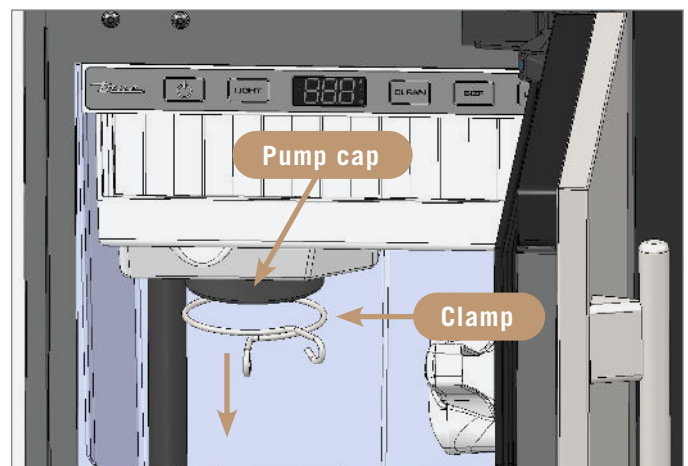

FIG. 1. Pump cap and clamp locations.

WINTERIZING



NOTICE: DO NOT ALLOW THE ICE MACHINE TO BE EXPOSED TO TEMPERATURES BELOW 32°F (0°C) WITHOUT WINTERIZING THE UNIT

AS THIS WILL CAUSE ANY WATER IN THE MACHINE TO FREEZE. FAILURES CAUSED BY EXPOSURE TO FREEZING TEMPERATURES ARE NOT COVERED BY THE WARRANTY.

USE THE FOLLOWING INSTRUCTIONS TO PREPARE YOUR ICE MACHINE FOR STORAGE OR WINTERIZATION:

1. Descale and sanitize the ice machine. See "Descaling & Sanitizing" (pg. 51).
2. Turn off the water supply to the machine.
3. Disconnect the incoming water line from the back of the unit.
4. Remove and discard the water filter. See "Water Filter Replacement" step 1 (pg. 47).
5. Press power  until the display shows **FIL**. Leave the machine on for 20 sec., and then press power to turn the unit off.
6. Drain the evaporator compartment by removing the pump clean-out cap. See "Pump Clean-out Cap" (pg. 57).
7. Pour 1 gallon of propylene glycol (RV antifreeze) into the bin drain to fill the drain pump.
8. Once the drain pump shuts off and all the propylene glycol is drained, unplug the unit or turn off the circuit breaker.
9. Wipe down the interior bin with a dry clean cloth.
10. Re-install the pump clean-out cap.

RESTARTING

Use the following instructions to restart your ice machine after winterization:

1. Install a new water filter in the unit. See "Water Filter Installation" (pg. 32).
2. Reconnect the incoming water line and turn on the water supply.
3. Plug in the unit.
4. Sanitize the ice machine. See "Sanitize" (pg. 54).
5. Press power  to start ice making.

NOTE: THE FRESH WATER THAT IS INTRODUCED DURING DESCALING AND START-UP WILL FLUSH THE PROPYLENE GLYCOL DOWN THE DRAIN.

SERVICING, REPLACING COMPONENTS & ADJUSTMENTS

REVERSING DOOR

DOOR ADJUSTMENT

HANDLE TIGHTENING

CONTACT US



PRESERVE THE MOMENT®

SERVICING & REPLACING COMPONENTS

NOTE: ANY APPLIANCE ADJUSTMENTS ARE TO BE MADE AFTER THE APPLIANCE HAS BEEN VERIFIED LEVEL AND PROPERLY SUPPORTED.

- Replace component parts with original equipment manufacturer (OEM) components.
- Contact the dealer or our parts department at **844-849-6226** or **TrueResidentialParts@truemfg.com** for replacement parts.
- Have a licensed service provider service your unit to minimize the risk of possible ignition due to incorrect parts or improper service and to ensure the operator's health and safety.
- Unplug the ice machine before cleaning or making any repairs. Powering off an electronic control may not remove power from all components (e.g., light circuits, perimeter heaters, and evaporator fans).

REVERSING DOOR

The new TUI-15 models come with articulating, soft-close hinges. The hinges can be installed on either the left-hand or right-hand orientation.

To order additional spacers of NSF cover screw caps, contact our parts department at **844-849-6226** or **TrueResidentialParts@TrueMfg.com**.

REQUIRED TOOLS

Required tools include (but may not be limited to) the following:

- 1/8" Hex Head Allen Wrench
- Putty Knife (if NSF cover present)

PROCEDURE

NOTE: FIGURES SHOW CONVERTING A RIGHT-HINGED DOOR TO A LEFT-HINGED DOOR.

1. Loosen the hinge bolts and remove the door. See fig. 1.
 2. If NSF Cover is present, carefully pry screw caps from the cover to access the door bracket screws. See fig. 2.
 3. If present, remove the door skin. See fig. 3.
 4. Remove the existing spacer. See fig. 3.
 5. Remove the hinge assemblies from the door assembly. See fig. 4.
 6. Shift the door brackets to the opposite side. See fig. 5.
 7. Install the bottom hinge at the top and the top hinge on the bottom. See figs. 6 and 7.
 8. Install the door skin. If present, reinstall the NSF cover screw caps.
 9. Move the remaining door hardware to the opposite sides. See fig. 8.
 10. Install the reversed door. Be sure to fully tighten the hinge screws.
- NOTE: BE SURE TO INSTALL THE CORRECT SPACER FOR YOUR DOOR ORIENTATION.**
11. Verify the door closes correctly and the gasket seals without gaps. Adjust the door as needed. See "Door Adjustment" (pg. 63).

SERVICING, REPLACING COMPONENTS & ADJUSTMENTS



FIG. 1. Slide the door off the hinge bolts through the keyhole slots.

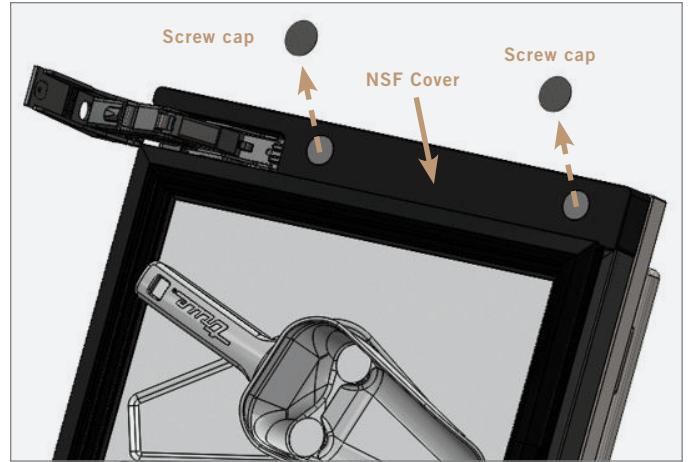

FIG. 2. Remove the NSF cover screw caps.

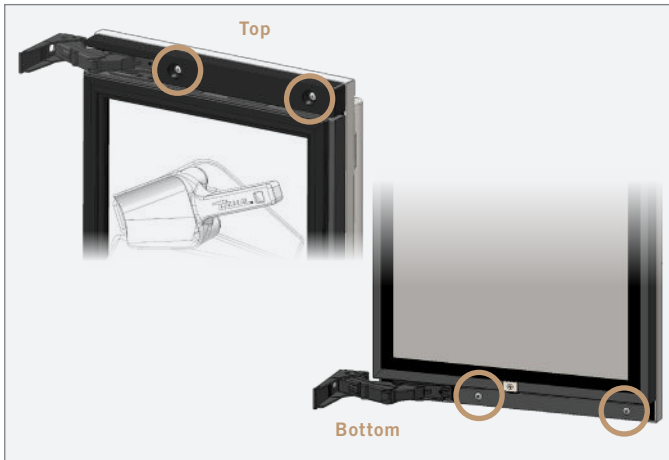

FIG. 3. Spacer and door bracket screw locations.

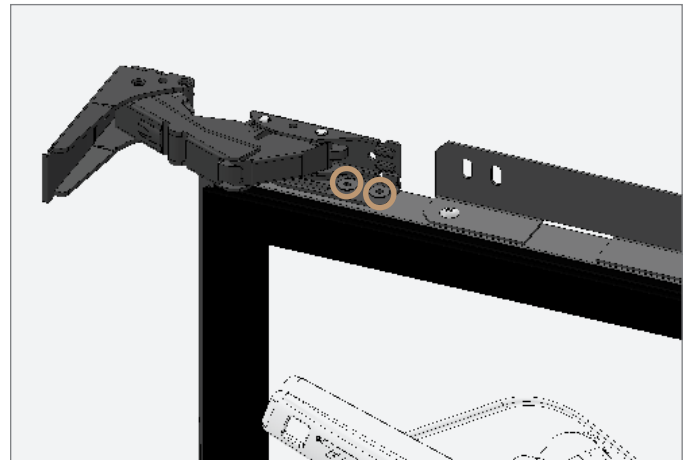

FIG. 4. Hinge door screw locations. Top hinge shown.



FIG. 5. Top Bracket shown. A: Door Skin bracket screw locations. B: Move the door skin bracket to the opposite side.

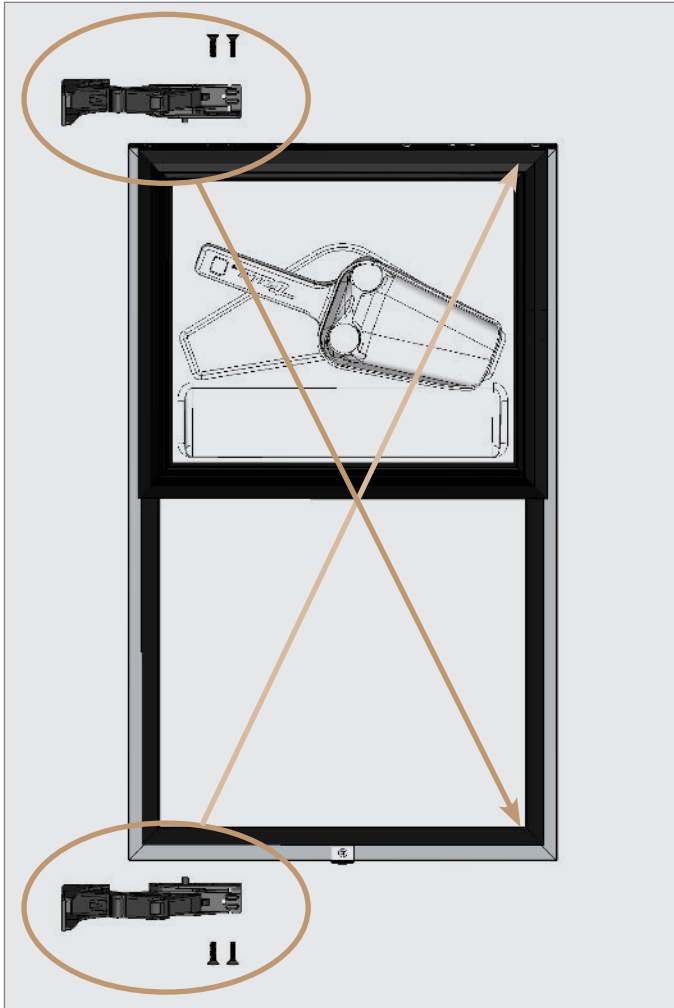

FIG. 6. Switch the top and bottom hinge assemblies with each other.

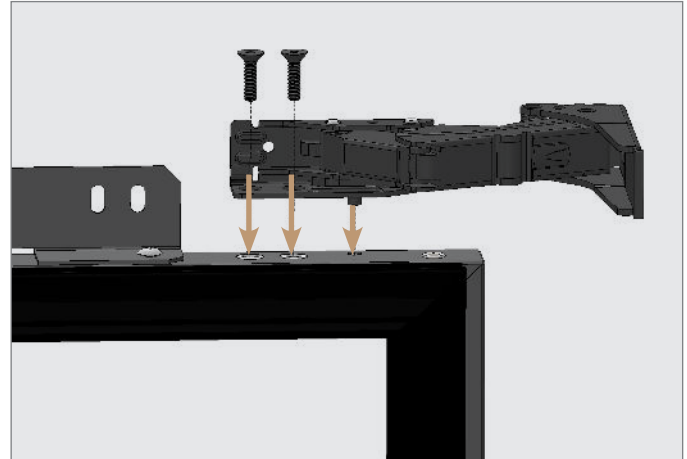

FIG. 7. Install the hinge assembly.

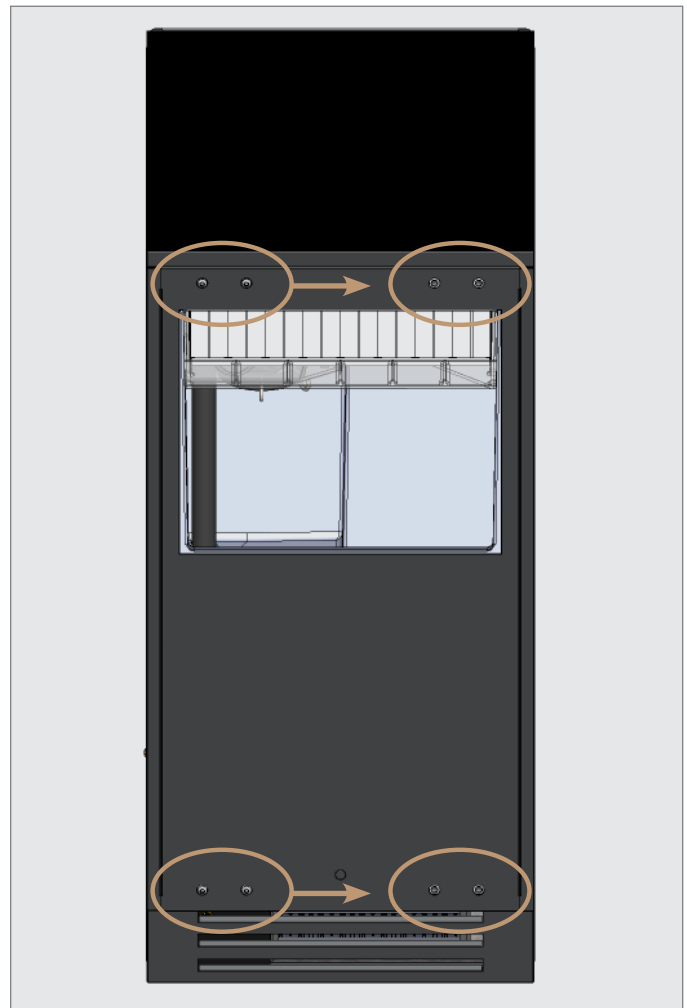

FIG. 8. Move the remaining door hardware to the opposite side.

DOOR ADJUSTMENT

Door skin bracket screw holes are slotted to assist with door adjustment. See figs. 1–3.

1. If applicable, remove the NSF cover screw caps.
2. Loosen the door skin bracket and spacer screws. See figs. 1–3.
3. Adjust the door skin / panel as needed.
4. Tighten the door skin bracket and spacer screws.
5. If applicable, reinstall NSF cover screw caps.

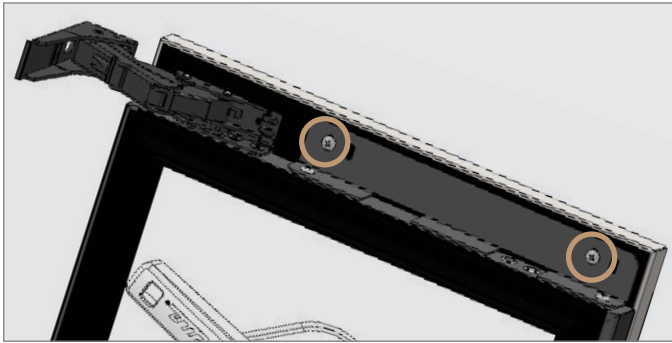

FIG. 1. Spacer / top door bracket screw locations.

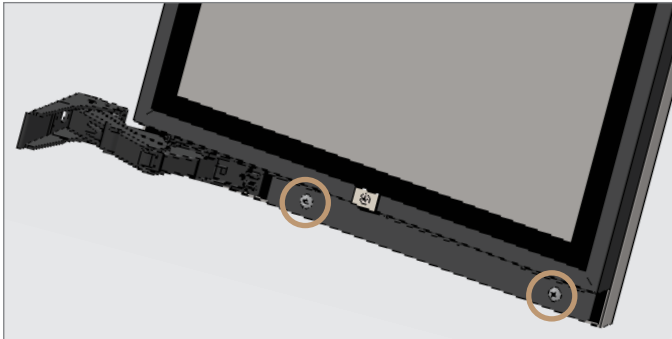

FIG. 2. Bottom door bracket screw locations.



FIG. 3. Bracket screw holes are slotted for easy adjustment. Screw removed for illustration.

HANDLE TIGHTENING

Tighten the handle with a 3/32" Allen wrench.

CONTACT US

For any questions about installation, please contact your TRUE dealer or TRUE Residential Technical Service. Please have your model and serial number (see serial label location below) available so we can better assist you with your service- or parts-related inquires.

Customer Service

Phone: 888-616-8783
info@true-residential.com

Warranty Department

Phone: 844-849-6179
TrueResidentialWarranty@truemfg.com

Service Department

Phone: 844-746-9423
TrueResidentialService@truemfg.com

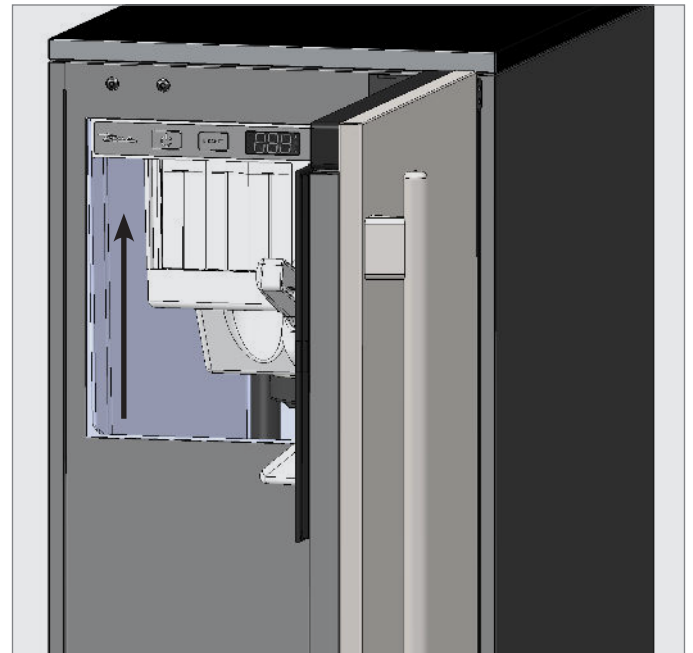

TRUE RESIDENTIAL® LIMITED ICE MACHINE WARRANTY

LIMITED 30 DAY COSMETIC WARRANTY

Stainless steel doors and handles are warranted to be free from defective materials and workmanship for a period of thirty (30) days from the date of original retail purchase. Any defects must be reported to the selling dealer within thirty (30) days from the date of original retail purchase. This limited warranty excludes any type of freight / concealed damage.

THREE-YEAR PARTS & LABOR WARRANTY

TRUE warrants to the original purchaser of every new TRUE Ice® machine, the cabinet and all parts thereof, to be free from defects in material and workmanship under normal and proper use and maintenance as specified by TRUE and upon proper installation and start-up in accordance with the instruction packet supplied with each TRUE unit. TRUE'S obligation under this warranty is limited to a period of three (3) years from the date of original installation or thirty-nine (39) months after shipment date from TRUE, whichever occurs first. Contact the TRUE Warranty regarding warranty for installations in a commercial/light commercial application.

SIX-YEAR SEALED SYSTEM WARRANTY – PARTS & LABOR

TRUE warrants its hermetically sealed system: compressor, evaporator coil, condenser coil, drier, metering device and connecting tubing to be free from defects in both material and workmanship under normal and proper use and maintenance service for a period of six (6) years from the date of original installation but not to exceed six (6) years and three (3) months after shipment from the manufacturer, whichever occurs first.

DISPLAY PRODUCTS

TRUE products on showroom display that are sold more than 3 years (36 months) from the invoice date to the dealer would carry a 1 year parts and labor warranty, along with an additional 4 year sealed system, parts only warranty.

TERMS APPLICABLE TO EACH WARRANTY

Any part covered under the aforementioned warranties that is determined by TRUE to have been defective within the time frame is limited to the repair or replacement, including labor charges, of defective parts or assemblies. The labor warranty shall include standard straight time labor charges only and reasonable travel time, as determined by TRUE. Units must be purchased through an authorized TRUE Residential dealer in order to qualify for warranty.

WARRANTY CLAIMS

All claims for labor or parts must be made directly through TRUE. All claims should include: model number and serial number of ice machine, proof of purchase, and date of installation. In case of warranted compressor, the compressor model tag, or picture of tag must be returned to TRUE along with the above listed information. Warranty labor claim is subject to denial if failed part is requested for return and it is not returned.

WHAT IS NOT COVERED BY THIS WARRANTY

This limited warranty does not cover any damage due to: (a) transportation; (b) storage; (c) installation; (d) improper use; (e) failure to follow the product instructions or to perform any preventive maintenance; (f) modifications or alterations; (g) neglect; (h) unauthorized repair; (i) normal wear and tear; or (j) external causes such as accidents, abuse, act of God, or other actions or events beyond our reasonable control.

This warranty does not cover failures related to the water supply, problems in the plumbing going to the unit, or external drain line malfunctions. Only connect your ice machine to a potable water supply. Also not covered are failures resulting from ambient conditions that are outside the limits specified in the owner's manual.

NO CONSEQUENTIAL DAMAGES

TRUE is not responsible for economic loss, profit loss or special, indirect or consequential damages, including without limitation, losses or damages arising from ice loss or ice replacement costs, normal maintenance, after-install adjustments or cleaning or water damage claims whether or not on account of refrigeration failure.

WARRANTY IS NOT TRANSFERABLE

This warranty is not assignable and applies only in favor of the original purchaser / user to whom delivered. Any such assignment or transfer shall void the warranties herein made and shall void all warranties, express or implied, including any warranty or merchantability or fitness for a particular purpose.

IMPROPER ELECTRICAL CONNECTIONS

TRUE is not responsible for the repair or replacement of failed or damaged components resulting from electrical power failure, high or low voltage, use of extension cords, or improper grounding of the unit.

REMEDY LIMITATIONS

TRUE'S sole obligation under this warranty is limited to either repair or replacement of parts. This warranty neither assumes nor authorizes any person to assume obligations other than those expressly covered by this warranty. The remedies described in this warranty statement are the sole and exclusive remedies and TRUE'S entire liability for any breach of this limited warranty. TRUE'S liability shall under no circumstances exceed the actual amount paid for the defective product, nor shall TRUE under any circumstances be liable for any consequential, incidental, special or punitive damages or losses, whether direct or indirect.

LIMIT ON IMPLIED WARRANTIES

TRUE limits the duration and remedies of all implied warranties, including without limitation the warranties of merchantability and fitness for a particular purpose to the duration of this express limited warranty statement.

YOUR RIGHTS UNDER STATE LAW

Some states do not allow the exclusion or limitation of consequential damages or a limitation on how long an implied warranty lasts, so these exclusions or limitations may not apply to you. This warranty gives you specific legal rights and you may have other rights that vary from state to state.

ENVIRONMENTAL ATTRIBUTES

Any and all environmental attributes, including environmental offset credit rights, with respect to TRUE® refrigeration units manufactured after September 1, 2015, shall remain the property of TRUE Manufacturing Co., Inc. and are not transferred.

OUTSIDE U.S./CANADA

This warranty does not apply to, and TRUE is not responsible for, any warranty claims made on products sold or used outside the United States or Canada.

SUBMIT WARRANTY CLAIMS TO: True Residential
2001 East Terra Lane
O'Fallon, MO 63366

TrueResidentialClaims@TrueMfg.com

DF_210682_04.23

CONTACT US

true-residential.com

636.240.2400 | toll free 888.616.8783



PRESERVE THE MOMENT®



BP_222928_11.23