

## INSTALLATION MANUAL FOR UNDERBAR REFRIGERATION



TDB-24-48-1-G-1



TD-50-18-S



TBB-2



TBB-3G-S



TDD-4

### TABLE OF CONTENTS

#### ► Safety Information

Safety Precautions	1
Proper Disposal	2
Connecting Electricity	3
Adapter Plugs	3

#### ► Installation / Operation Instructions

Ownership	4
Required Tools	4
Uncrating	4
Location	5
Leveling Cabinet	5
Slide Doors	6
Wire Gauge Cart	7
Sealing Cabinet to the floor	8
Electrical Instructions	9
Direct Draw Draft Arm Installation	9-10
Start-up and Light Switch Location	10
Temperature Control Adjustment	12
Shelving & Bin Divider Installation	13
Storage & Handling	13
Temperature/Pressure/Tapping	14

#### ► Maintenance, Care & Cleaning

Draft Beer Problems	15
Changing CO <sub>2</sub> Gas Cylinder	16
Cleaning Bar System	17
Cleaning the Condenser	18
Important Warranty Information	19
Stainless Steel Equipment Care & Cleaning	20-21
Lightbulb Replacement	22
Warranty (U.S.A. and Canada ONLY!)	23

\*Spanish, German, French, and Dutch versions included.

### CONGRATULATIONS!

*You have just purchased the finest commercial refrigerator available. You can expect many years of trouble-free operation.*

# UNDERBAR REFRIGERATION

# NOTICE TO CUSTOMER:



**Loss Or Spoilage Of Products  
In Your Refrigerator/Freezer  
Is NOT Covered By Warranty.  
In Addition To Following  
Recommended Installation  
Procedures You Must Run  
The Refrigerator/Freezer  
24 Hours Prior To Usage.**

True Manufacturing Company, Inc.

SAFETY INFORMATION

# **How to Maintain Your Unit to Receive the Most Efficient and Successful Operation**

*You have selected one of the finest commercial refrigeration units made. It is manufactured under strict quality controls with only the best quality materials available. Your TRUE cooler when properly maintained will give you many years of trouble-free service.*

## **WARNING!**

***Use this appliance for its intended purpose as described in this Owner Manual.***

***This cabinet contains fluorinated greenhouse gas covered by the Kyoto Protocol (please refer to cabinet's inner label for type and volume, GWP of 134a= 1,300. R404a= 3,800).***

## **SAFETY PRECAUTIONS**

*When using electrical appliances, basic safety precautions should be followed, including the following:*

- This refrigerator must be properly installed and located in accordance with the Installation Instructions before it is used.
- Do not allow children to climb, stand or hang on the shelves in the refrigerator. They could damage the refrigerator and seriously injure themselves.
- Do not touch the cold surfaces in the freezer compartment when hands are damp or wet. Skin may stick to these extremely cold surfaces.
- Do not store or use gasoline or other flammable vapors and liquids in the vicinity of this or any other appliance.
- Keep fingers out of the “pinch point” areas; clearances between the doors and between the doors and cabinet are necessarily small; be careful closing doors when children are in the area.

### **NOTE**

*We strongly recommend that any servicing be performed by a qualified individual.*

- Unplug the refrigerator before cleaning and making repairs.
- Setting temperature controls to the 0 position does not remove power to the light circuit, perimeter heaters, or evaporator fans.

SAFETY INFORMATION

**DANGER!**  
**RISK OF CHILD ENTRAPMENT**

**PROPER DISPOSAL OF THE REFRIGERATOR**

---

Child entrapment and suffocation are not problems of the past. Junked or abandoned refrigerators are still dangerous... even if they will sit for “just a few days.” If you are getting rid of your old refrigerator, please follow the instructions below to help prevent accidents.

**Before You Throw Away Your Old Refrigerator or Freezer:**

- Take off the doors.
- Leave the shelves in place so that children may not easily climb inside.

**Refrigerant Disposal**

Your old refrigerator may have a cooling system that uses “Ozone Depleting” chemicals. If you are throwing away your old refrigerator, make sure the refrigerant is removed for proper disposal by a qualified service technician. If you intentionally release any refrigerants you can be subject to fines and imprisonment under provisions of the environmental regulations.

**USE OF EXTENSION CORDS**

---

*NEVER USE AN EXTENSION CORD! TRUE will not warranty any refrigerator that has been connected to an extension cord.*

**REPLACEMENT PARTS**

---

- Component parts shall be replaced with like components.
- Servicing shall be done by authorized service personnel, to minimize the risk of possible ignition due to incorrect parts or improper service.
- Lamps must be replaced by identical lamps only.
- If the supply cord is damaged, it must be replaced by a special cord or assembly available from the manufacturer or its service agent.

SAFETY INFORMATION

# WARNING!

## HOW TO CONNECT ELECTRICITY

*Do not, under any circumstances, cut or remove the ground prong from the power cord. For personal safety, this appliance must be properly grounded.*

The power cord of this appliance is equipped with a grounding plug which mates with a standard grounding wall outlet to minimize the possibility of electric shock hazard from this appliance.

Have the wall outlet and circuit checked by a qualified electrician to make sure the outlet is properly grounded.

If the outlet is a standard 2-prong outlet, it is your personal responsibility and obligation to have it replaced with the properly grounded wall outlet.

The refrigerator should always be plugged into it's own individual electrical circuit, which has a voltage rating that matches the rating plate.

This provides the best performance and also prevents overloading building wiring circuits which could cause a fire hazard from overheated wires.

Never unplug your refrigerator by pulling on the power cord. Always grip plug firmly and pull straight out from the outlet.

Repair or replace immediately all power cords that have become frayed or otherwise damaged. Do not use a cord that shows cracks or abrasion damage along its length or at either end.

When removing the refrigerator away from the wall, be careful not to roll over or damage the power cord.

## USE OF ADAPTER PLUGS

*NEVER USE AN ADAPTER PLUG! Because of potential safety hazards under certain conditions, we strongly recommend against the use of an adapter plug.*

The incoming power source to the cabinet including any adapters used must have the adequate power available and must be properly grounded. Only adapters listed with UL should be used.

North America Use Only!

NEMA plugs

TRUE uses these types of plugs. If you do not have the right outlet have a certified electrician install the correct power source.



115/60/1  
NEMA-5-15R

INSTALLATION / OPERATION INSTRUCTIONS

**INSTALLATION / OPERATION INSTRUCTIONS**

**OWNERSHIP**

To ensure that your unit works properly from the first day, it must be installed properly. We highly recommend a trained refrigeration mechanic and electrician install your TRUE equipment. The cost of a professional installation is money well spent.

Before you start to install your TRUE unit, carefully inspect it for freight damage. If damage is discovered, immediately file a claim with the delivery freight carrier. **TRUE is not responsible for damage incurred during shipment.**

**REQUIRED TOOLS**

- Adjustable Wrench
- Phillips Head Screwdriver
- Level

**UNCRATING**

The following procedure is recommended for uncrating the unit:

- A.** Remove the outer packaging, (cardboard and bubbles or styrofoam corners and clear plastic). Inspect for concealed damage. Again, immediately file a claim with the freight carrier if there is damage.
- B.** Move your unit as close to the final location as possible before removing the wooden skid.
- C.** Remove door bracket on swinging glass door models (see image 1-2).

**NOTE**

Keys for coolers with door locks are located in warranty packets.



**REMOTE UNITS (This section applies to remotes only!)**

- Remote cabinets must be ordered as remote. We do not recommend converting for a standard self contained to remote system.
- All remote cabinets must be hard wired.
- No castors available.
- All remote cabinets come standard using 404A refrigerant.
- All remote units come standard with expansion valve, liquid line solenoid, heated condensate pan, and defrost timer when applicable.

- Contact TRUE Technical Service for BTU requirements.
- No wiring necessary between cabinet and condensing unit.
- All remote condensing units purchased from TRUE are 208/230 volts single phase.

**If you have any questions regarding this section, please call TRUE at 1-(800)-325-6152.**

## INSTALLATION / OPERATION INSTRUCTIONS

### LOCATING

#### TOOLS REQUIRED:

- Phillips screw driver
  - 3/8" socket or 3/8" wrench
- A.** Use a phillips screw driver and remove four screws from the L-bracket connected the unit to the wood skid (see image 1). Then use a 3/8" socket or wrench and remove the L-bracket from the unit (see image 2).

Removing bracket from skid.



Removing bracket from cabinet.



*When lifting unit do not use the countertop as a lifting point. Also remember to leave cabinet upright for 24 hours before plugging into power source.*

- B.** Remove skid by unscrewing all base rail anchor brackets. Place skid to the side.
- C.** Carefully upright cabinet.
- D.** Appliance tested according to the climate classes 5 and 7 for temperature and relative humidity.

### LEVELING

- A.** Set unit in its final location. Be sure there is adequate ventilation in your room. Under extreme heat conditions, (100°F+, 38°C+), you may want to install an exhaust fan.

#### WARNING

*Warranty is void if ventilation is insufficient.*

- B.** Proper leveling of your TRUE cooler is critical to operating success (for non-mobile models). Effective condensate removal and door operation will be effected by leveling.
- C.** The cooler should be leveled front to back and side to side with a level.

- D.** Ensure that the drain hose or hoses are positioned in the pan.
- E.** Free plug and cord from inside the lower rear of the cooler (do not plug in).
- F.** The unit should be placed close enough to the electrical supply so that extension cords are never used.

#### WARNING

*Cabinet warranties are void if OEM power cord is tampered with. True will not warranty any units that are connected to an extension cord.*

### SLIDE DOOR UNITS WITH HOLD OPEN FEATURE

These instructions explain how to keep door in open position.

- A.** Slide the door open.
- B.** Latch the door in the open position from the back side of door (notch in track).
- C.** Door latch in image 1 is in the open position.
- D.** Door latch in image 2 is in the closed position.



INSTALLATION / OPERATION INSTRUCTIONS

**SLIDE DOORS**

**STEP 1**

Doors can not be removed unless placed in specific locations stated in these instructions.

**STEP 2**

**Two Door Units:** Slide the front door so it is centered on the cabinet. The door can not be removed unless it is centered. See image 1 for door channel openings and image 2 for centering door.

**Three Door Units:** Slide the middle door to the right so it is centered with the left edge of the right door. See image 3.

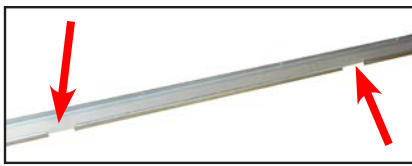

Image 1 (Two Door Units ONLY)



Image 2 (Two Door Units ONLY)



Image 3 (Three Door Units ONLY)



Image 4

**STEP 3**

After centering the door lift it up and tilt top of door towards the back of the unit so the rollers are out of the top channel. Swing the bottom of the door out of the bottom channel. Then remove the door and set it down. See image 4.

**(TWO DOOR UNITS SKIP TO STEP 6)**

**STEP 4 (Three Door Units Only)**

Slide right door to the left so left edge lines up with the left edge of True Logo located above the door. See image 5a. Then lift door out of track as described in Step 3.



Image 5a



Image 5b

**STEP 5 (Three Door Units Only)**

Slide left door to the right so right edge lines up with the right edge of the True Logo located at the top of the door frame. See image 5b. Then lift door out of track as described in Step 3.

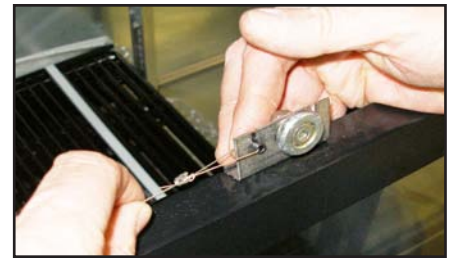

Image 6

**STEP 6**

Remove door cord from roller bracket. The black plastic tab holding the door cord slides out the back. Slowly let the door cord retract back to the track. See image 6.

**STEP 7**

When reinstalling door make sure door cord grommet attaches to roller slot closest to pulley. (See image 7 and 8).

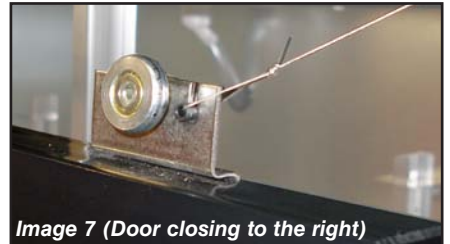

Image 7 (Door closing to the right)

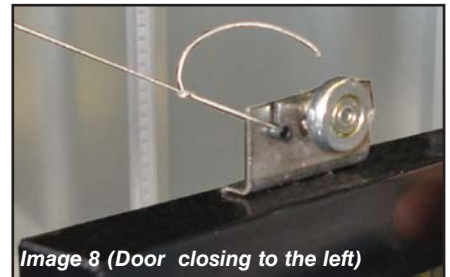

Image 8 (Door closing to the left)

**TO ADJUST SLIDE DOOR**

**STEP 1**

After cabinet is installed in a final location and correctly leveled check for any openings when the slide doors are completely closed. If there are any gaps/openings between the closed doors and cabinet, the doors will need to be adjusted.

**STEP 2**

Using a 7/16" wrench or adjustable wrench and 1/8" allen wrench loosen roller and move along slotted hole. After adjustment has been made tighten the roller into place. See image 9.



Image 9



*INSTALLATION / OPERATION INSTRUCTIONS*  
**CONDUCTORS AND CIRCUITS**

**Wire Gauge for 2% Voltage Drop in Supply Circuits.**

115 Volt Amps	<i>Distance In Feet To Center of Load</i>											
	20	30	40	50	60	70	80	90	100	120	140	160
2	14	14	14	14	14	14	14	14	14	14	14	14
3	14	14	14	14	14	14	14	14	14	14	14	12
4	14	14	14	14	14	14	14	14	14	12	12	12
5	14	14	14	14	14	14	14	12	12	12	10	10
6	14	14	14	14	14	14	12	12	12	10	10	10
7	14	14	14	14	14	12	12	12	10	10	10	8
8	14	14	14	14	12	12	12	10	10	10	8	8
9	14	14	14	12	12	12	10	10	10	8	8	8
10	14	14	14	12	12	10	10	10	10	8	8	8
12	14	14	12	12	10	10	10	8	8	8	8	6
14	14	14	12	10	10	10	8	8	8	6	6	6
16	14	12	12	10	10	8	8	8	8	6	6	6
18	14	12	10	10	8	8	8	8	8	8	8	5
20	14	12	10	10	8	8	8	6	6	6	5	5
25	12	10	10	8	8	6	6	6	6	5	4	4
30	12	10	8	8	6	6	6	6	5	4	4	3
35	10	10	8	6	6	6	5	5	4	4	3	2
40	10	8	8	6	6	5	5	4	4	3	2	2
45	10	8	6	6	6	5	4	4	3	3	2	1
50	10	8	6	6	5	4	4	3	3	2	1	1

**Wire Gauge for 2% Voltage Drop in Supply Circuits.**

230 Volt Amps	<i>Distance In Feet To Center of Load</i>											
	20	30	40	50	60	70	80	90	100	120	140	160
5	14	14	14	14	14	14	14	14	14	14	14	14
6	14	14	14	14	14	14	14	14	14	14	14	12
7	14	14	14	14	14	14	14	14	14	14	12	12
8	14	14	14	14	14	14	14	14	14	12	12	12
9	14	14	14	14	14	14	14	14	12	12	12	10
10	14	14	14	14	14	14	14	12	12	12	10	10
12	14	14	14	14	14	14	12	12	12	10	10	10
14	14	14	14	14	14	12	12	12	10	10	10	8
16	14	14	14	14	12	12	12	10	10	10	8	8
18	14	14	14	12	12	12	10	10	10	8	8	8
20	14	14	14	12	10	10	10	10	10	8	8	8
25	14	14	12	12	10	10	10	10	8	8	6	6
30	14	12	12	10	10	10	8	8	8	6	6	6
35	14	12	10	10	10	8	8	8	8	6	6	5
40	14	12	10	10	8	8	8	6	6	6	5	5
50	12	10	10	8	6	6	6	6	6	5	4	4
60	12	10	8	6	6	6	6	6	5	4	4	3
70	10	10	8	6	6	6	5	5	4	4	2	2
80	10	8	8	6	6	5	5	4	4	3	2	2
90	10	8	6	6	5	5	4	4	3	3	1	1
100	10	8	6	6	5	4	4	3	3	2	1	1

---

**INSTALLATION / OPERATION INSTRUCTIONS**

---

**SEALING CABINET TO FLOOR**

---

**Step 1 - Position Cabinet**

Allow one inch between the wall and rear of the refrigerated Bar Equipment to assure proper ventilation. For Glass & Plate Chillers/Frosters 3 inches between the wall and rear of the cabinet will assure proper ventilation.

**Step 2 - Level Cabinet**

Cabinet should be level, side to side and front to back. Place a carpenter's level in the interior floor in four places:

- A.** Position level in the inside floor of the unit near the doors. (Level should be parallel to cabinet front). Level cabinet.
- B.** Position level at the inside rear of cabinet. (Again level should be placed parallel to cabinet back).
- C.** Perform similar procedures to steps **A** & **B** by placing the level on inside floor (left and right sides - parallel to the depth of the cooler). Level cabinet.

**Step 3**

Draw an outline on the base on the floor.

**Step 4**

Raise and block the front side of the cabinet.

**Step 5**

Apply a bead of "NSF Approved Sealant", (see list below), to floor on half inch inside the outline drawn. The bead must be heavy enough to seal the entire cabinet surface when it is down on the sealant.

**Step 6**

Raise and block the rear of the cabinet

**Step 7**

Apply sealant on floor as outlined in Step 5 on other three sides.

**Step 8**

Examine to see that cabinet is sealed to floor around entire perimeter.

**Note:**

Asphalt floors are very susceptible to chemical attack. A layer of tape on the floor prior to applying the sealant will protect the floor.

**NSF Approved Sealants:**

1. Minnesota Mining #ECU800 Caulk
2. Minnesota Mining #ECU2185 Caulk
3. Minnesota Mining #ECU1055 Bead
4. Minnesota Mining #ECU1202 Bead
5. Armstrong Cork - Rubber Caulk
6. Products Research Co. #5000 Rubber Caulk
7. G.E. Silicone Sealer
8. Dow Corning Silicone Sealer

INSTALLATION / OPERATION INSTRUCTIONS

**ELECTRICAL INSTRUCTIONS**

- A.** Before your new unit is connected to a power supply, check the incoming voltage with a voltmeter. If anything less than 100% of the rated voltage for operation is noted, correct immediately.
- B.** All units are equipped with a service cord, and must be powered at proper operating voltage at all times. Refer to cabinet data plate for this voltage.

TRUE recommends that a sole use circuit be dedicated for the unit.

**WARNING**

Compressor warranties are void if compressor burns out due to low voltage.

**WARNING**

Power supply cord ground should not be removed!

**WARNING**

Do not use electrical appliances inside the food storage compartments of the appliances unless they are of the type recommended by the manufacturer.

**NOTE**

To reference wiring diagram - Remove front louvered grill, wiring diagram is positioned on the inside cabinet wall.

**DIRECT DRAW DRAFT ARM INSTALLATION**

On direct draws, the drain is located at the front of the cabinet. To plumb in the drain, connect 3/4" (2cm) P.V.C. pipe to the 3/4" (2cm) barbed fitting supplies with the unit.

**CO<sub>2</sub> PRESSURE**

Mobile tapsters, to retain complete mobility, the CO<sub>2</sub> tank (up to five pounds in size) can be placed inside the cooler (strap holders furnished).

**CAUTION**

Filled CO<sub>2</sub> tanks are potentially dangerous because of the pressure they contain. If you are unfamiliar with their use or the use of the CO<sub>2</sub> regulator, seek information from your local distributor, or your local beverage man before proceeding.

**INSTALL DRAFT ARM**

Place rubber washer over draft arm mounting holes in cabinet, put beer line connector down through hole. Next, secure draft arm with four screws. (See images 1-6)



1  
Draft arm install contents.  
(Draft arm not shown)



2  
Beer line connector.



3  
Thread beer line connector to draft arm and secure draft arm to cabinet with rubber gasket under the draft arm.



6  
Thread beer draft arm handle onto the draft arm.

**CONTINUED ON NEXT PAGE...**

INSTALLATION / OPERATION INSTRUCTIONS

**DIRECT DRAW DRAFT ARM INSTALLATION CONTINUED...**

**INSTALL DRAFT ARM continued...**

Insert air hose (one inch plastic tube) in draft arm, being careful not to disturb insulation. Remove top cover of draft arm and attach air hose clip to the insulating sleeve at the top of the draft arm. Replace top cover. The air hose clip will assure that the hose remains in proper place at all times, keeping the beer faucet cold. (See image 7-9)



**STARTUP**

- A.** The compressor is ready to operate. Plug in the cooler.
- B.** Temperature control set at No. 4 position gives refrigerators an approximate temperature of 35°F and glass chiller frosters have an approximate temperature of 0°F. Allow unit to function several hours, completely cooling cabinet before changing the control setting.
- C.** Excessive tampering with the control could lead to service difficulties. Should it ever become necessary to replace temperature control, be sure it is ordered from your TRUE dealer or recommended service agent.
- D.** Good air flow in your TRUE unit is critical. Be careful to load product so that it neither presses against the back wall, nor comes within four inches of the evaporator housing. Refrigerated air off the coil must circulate down the back wall.

**NOTE**

*If the unit is disconnected or shut off, wait five minutes before starting again.*

**RECOMMENDATION**

*Before loading product we recommend you run your TRUE unit empty for two to three days. This allows you to be sure electrical wiring and installation are correct and no shipping damage has occurred. Remember, our factory warranty does not cover product loss!*

**REPLACEMENT PARTS**

*TRUE maintains a record of the cabinet serial number for your cooler. If at any time during the life of your cooler, a part is needed, you may obtain this part by furnishing the model number and serial number to the company from whom you purchased the cooler. Call Toll-Free: (800)-424-TRUE (Direct to Parts Department). (800)-325-6152 (U.S.A. & Canada only) or call: (636)-240-2400.*

**LIGHT SWITCH LOCATION:**

The switch is located on the front of the evaporator housing toward the front of the cabinet. Open the front doors and the switch will be visible close to the ceiling the cabinet.

**YOUR TRUE GLASS & PLATE CHILLER MAY USE AN ELECTRONIC CONTROL - 115V/60HZ ONLY**

**IF YOUR CABINET IS PRODUCED WITH AN ELECTRONIC CONTROL, THERE MAY BE UP TO A 20 MINUTE DELAY WHEN CABINET IS PLUGGED IN.**

*If the serial number on your cabinet is higher than listed below, it was produced with an electronic control.*

T-24-GC / T-24-GC-S  
S# 7721857

T-36-GC / T-36-GC-S  
S# 7218795

T-50-GC / T-50-GC-S  
SN 7147406

**DANFOSS ELECTRONIC TEMPERATURE CONTROL**  
**GENERAL SEQUENCE OF OPERATION**

1. Cabinet is plugged in.
  - a. Interior lights will illuminate of Glass Door Models only. If lights do not come on verify the light switch is in the "ON" position. Solid door cabinet may or may not have lights that may be controlled by the door switch.
  - b. Cabinet will start in a Defrost Cycle.
  
2. During the initial Defrost Cycle, the evaporator fan(s) and the compressor will remain off for a minimum of 4 minutes.
  - a. After the Defrost Cycle there will be a 2 minute delay.
  - b. After the 2 minute delay the compressor will start.
  - c. The evaporator fans will remain off for an additional 3 minutes.
  
3. The Danfoss control will cycle the compressor and the evaporator fan(s) on and off together.
  - a. The temperature control is sensing the discharge air temperature.
  - b. The temperature control should be set on the #4 or #5.
  - c. The warmest setting is #1 and #0 is the off position.
  - d. The thermometer is designed to read and display a cabinet temperature not a product temperature. This cabinet temperature may reflect the refrigeration cycle determined by the temperature control. The most accurate temperature on a cabinets operation is to verify the product temperature.
  
4. The Danfoss control is preprogrammed to initiate defrost every 4 hours of compressor run time.
  - a. At this time the compressor and evaporator fan(s) will turn off and the evaporator coil heater and drain tube heater will be energized. Some cabinets may also change the rotation of the reversing condenser fan motor.
  - b. Once a preprogrammed temperature of the evaporator coil is reached, the Defrost Cycle will terminate and the 2 minute delay will occur.
  - c. After the 2 minute delay the compressor will restart.
  - d. The evaporator fans will remain off for an additional 3 minutes.

INSTALLATION / OPERATION INSTRUCTIONS

# TEMPERATURE CONTROL ADJUSTMENT FOR HIGH ALTITUDE ONLY!

**TERMS:**

Cut-out - Temperature sensed by the controller that shuts the compressor off.

Cut-in - Temperature sensed by the controller that turns the compressor on.

**REQUIRED TOOLS**

- Phillips Head Screwdriver
- 5/64" or 2 mm Allen Wrench
- T-7 Torx Wrench

**STEP 1**

Unplug the cooler.

**STEP 2**

Remove the screws that secure the temperature control to the inset box.

**STEP 3**

Pull out gently from cabinet.

**NOTE:**

**Mechanical temperature controllers are affected when functioning at high altitude. The cut-in and cut-out temperatures will be colder than when the controller functions closer to sea level**

**STEP 4**

For high elevation installations, it may be necessary to "warm-up" the set points. To make the adjustment, insert the appropriate tool in each adjustment screw and turn 1/4 of a revolution clockwise (to the right). This procedure will adjust both the cut-in and cut-out about 2°F warmer.

**STEP 5**

Make sure to reconnect the pink wire to the proper spade terminal when reinstalling.

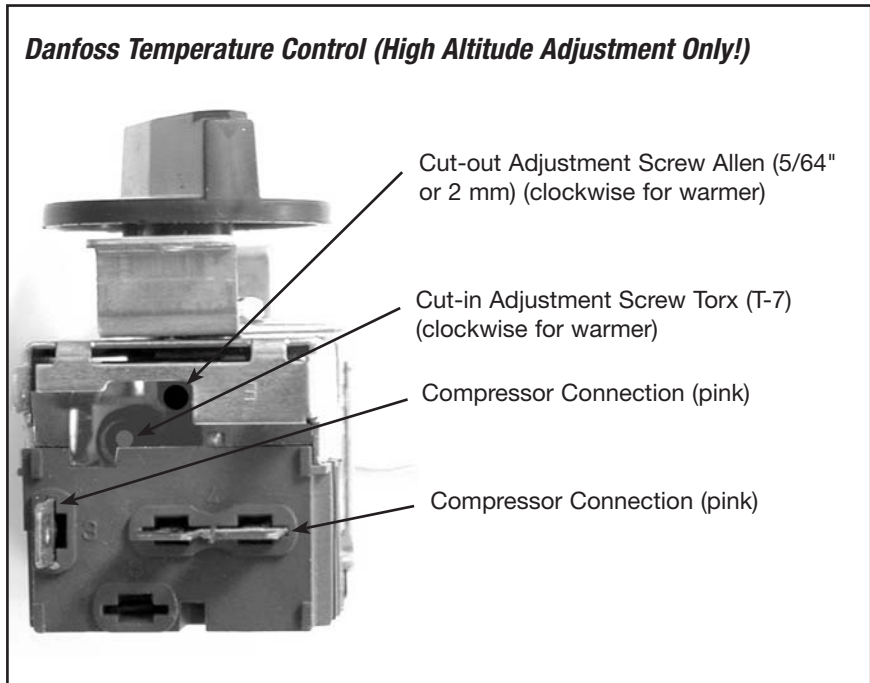

INSTALLATION / OPERATION INSTRUCTIONS

# SHELVING and BIN DIVIDER INSTALLATION / OPERATION

**SHELF INSTALLATION:**

- A. Hook shelf clips onto shelf standards.
- B. Position all four shelf clips equal in distance from the floor for flat shelves.
- C. Shelves are oriented so that cross support bars are facing down.
- D. Place shelves on shelf clips making sure all corners are seated properly.

**HORIZONTAL BOTTLE COOLER BIN DIVIDER INSTALLATION:**

Horizontal bottle coolers are shipped with bin dividers in place. If it is necessary to adjust spacing the following procedure is recommended.

- A. Dividers are spring loaded - push divider towards rear of the cooler to release from front grommets holes.
- B. Lineup divider front pegs with desired holes and punch through interior tape lining of both top and bottom holes - bottom peg first (front holes are taped over to improve insulation values).
- C. Remove divider from the front holes and line up regular and spring loaded rear pegs with holes in line with those desired in front. Insert as far as possible and maneuver front pegs in place.

**SHELF INSTALLATION**

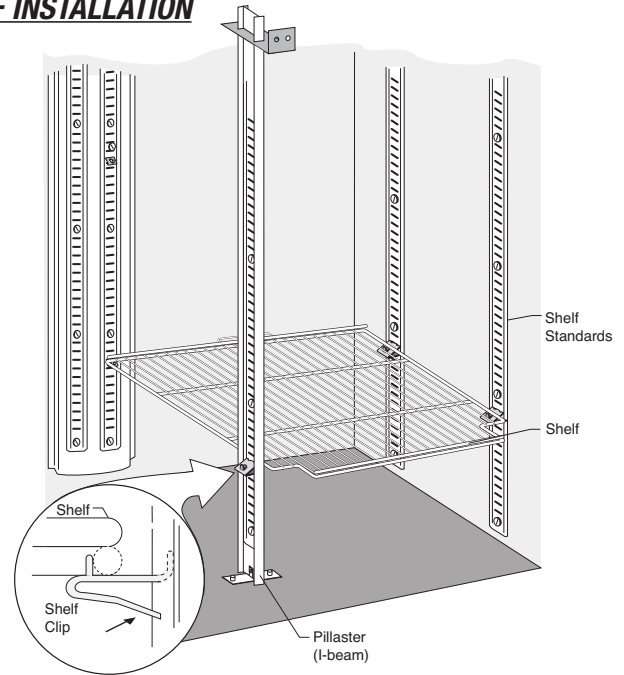

**BIN DIVIDER INSTALLATION**

**NOTE**  
 Divider positioned in front of mechanical box requires specific notch cut out.

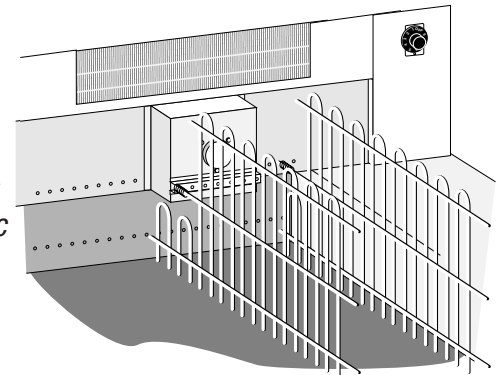

## STORAGE AND HANDLING

Draft beer should be treated as a food product. In most instances draft beer is not pasteurized. It is very important that you store and handle it properly.

Follow these steps to ensure the highest quality and consumer satisfaction.

- Draft beer should be immediately stored in a refrigerated cabinet.
- Draft beer products have a recommended shelf life. If you have questions regarding the shelf life of any of your draught products, please consult with your supplying depot or respective Brewer representative.

- Kegs should be stored separately from food products. If your cooler is used to refrigerate draught and food products, it is very important that the food not be stored near or on the kegs.
- Keg storage and dispensing areas should be kept clean to prevent any possibility of contaminating your draught products.

INSTALLATION / OPERATION INSTRUCTIONS

**TEMPERATURE**

- Correct temperature is a key factor to consider in storing and dispensing draft beer. Too cool or too warm may cause flavor loss, off taste and dispensing problems.

**Helpful Hints on Controlling Temperature**

- Keep a thermometer handy

- Monitor temperature of draft in your cooler and at the tap
- Keep cooler door closed as much as possible to avoid temperature fluctuation
- Regular maintenance of refrigeration equipment is recommended

**PRESSURE**

**Dispensing pressures differ according to:**

- The type of draft dispensing system
- The length of draft dispensing line
- The actual product - some require more, some require less
- The temperature of the product
- The pressurizing agent: air pressure, CO<sub>2</sub> or special blended gases.

**Helpful Hints On Maintaining The Correct Pressure:**

- Know which pressurizing agent to use on which product and why.
- Monitor your regulators to ensure applied pressure remains constant.
- Keep equipment in good repair.

**TAPPING**

Do not agitate the kegs unnecessarily. If excessive agitation occurs allow kegs to settle for 1 to 2 hours before tapping.

Prior to tapping the keg, ensure that all beer faucet in the serving location are in the off position. Completely remove the dust cover (identification cap) from the keg.

**TDD-1 CO<sub>2</sub> KNOCK-OUT**

This instruction is TRUE's recommended procedure for installing a remote CO<sub>2</sub> container.

**REQUIRED TOOLS**

- Pliers
- Power Drill
- Silicone Sealer
- Drill bit, 1/2"

**STEP 1**

Remove black knockout plug with a pair of pliers.

**NOTE:**

Knockout plug for CO<sub>2</sub> line can be locate in two different areas. View diagram to locate these two areas.

**STEP 2**

Use drill and bit to bore hole straight back through wall into compressor compartment.

**STEP 3**

Snake CO<sub>2</sub> line through hole down and around exiting behind rear castor underneath rear grill.

**STEP 4**

Seal hole around CO<sub>2</sub> line with silicone sealer to prevent cold air leakage.

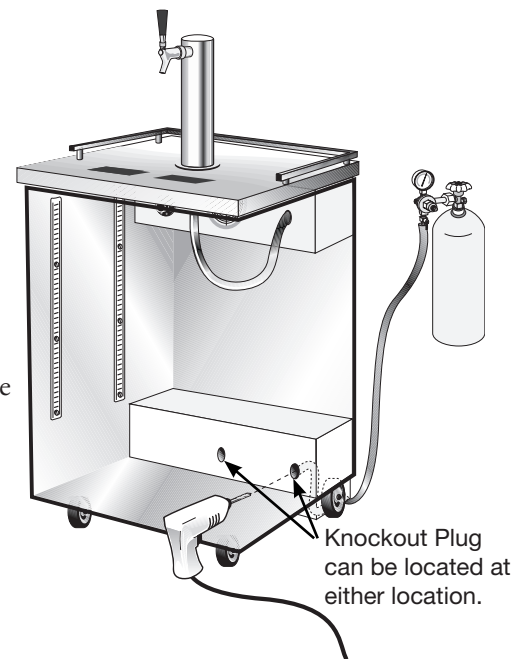



## **MAINTENANCE, CARE & CLEANING**

### **DRAFT BEER PROBLEMS**

---

*To minimize draft beer problems, always follow the recommended instructions for temperature and CO<sub>2</sub> pressures from your beer supplier.*

**Flat Beer - Description: Foamy head disappears quickly. Beer lacks usual zestful brewery fresh flavor.**

- CO<sub>2</sub> turned off when not in use.
- Contaminated air source (associated with compressed air).
- Greasy glasses.
- Not enough pressure.
- Pressure shut off during night.
- Loose tap or vent connection.
- Sluggish pressure regulator.
- Obstruction in lines.

**False Head - Description: Large soap-like bubbles, head dissolves very quickly.**

- Dry glasses.
- Improper pour.
- Pressure required does not correspond to beer temperature.
- Coils or direct draw beer lines warmer than beer in keg.
- Small lines into large faucet shanks.
- Beer drawn improperly.

**Wild Beer - Description: Beer, when drawn, is all foam and not enough liquid beer.**

- Beer drawn improperly.
- Faucet in bad or worn condition.
- Kinks, dents, twists or other obstructions in line.
- Traps in beer lines.
- Beer too warm in kegs or lines.
- Too much pressure.
- Creeping gauge causing too much pressure.

**Cloudy Beer - Description: Beer in the glass appears hazy. Not clear.**

- Dirty glass or faucet.
- Beer over chilled.
- Beer temperature variance in keg (Beer may have warmed up at sometime).
- Hot spots in beer lines.
- Cutting beer through faucet.
- Beer line in poor condition.
- Dirty lines.
- Beer that has been frozen.

**Bad Taste**

- Dirty faucet.
- Old or dirty beer lines.
- Failure to flush beer lines with water after each empty keg.
- Unsanitary conditions at bar.
- Foul air or dirt in lines.
- Oily air; greasy kitchen air.
- Temperature of package too warm.
- Dry glasses

## CHANGING CO<sub>2</sub> GAS CYLINDER

**Follow these instructions at ALL times when you replace a CO<sub>2</sub> gas cylinder:**

1. Close cylinder at "A".
2. Remove tap "D" from barrel. Pull pressure release ring on body of tap to release pressure remaining in line. (do not close "C")
3. Remove or loosen regulator key "B" by turning counter clockwise.
4. Remove regulator from used cylinder at "E".
5. Remove dust cap from new gas cylinder at "E" and clear dust from outlet by opening and closing valve "A" quickly using appropriate wrench.
6. Attach regulator to new cylinder at "E". (use new fiber/plastic washer, if required).
7. Open valve "A" all the way.
8. Close valve "C".
9. Adjust regulator key "B" by turning clockwise to set pressure. (check setting by opening "C" and pulling and releasing the ring "F" on the pressure release valve on the body of the tap)
10. Tap barrel at "D" with valve "C" open.

### NOTE

*Don't lay CO<sub>2</sub> cylinders flat.  
Don't drop CO<sub>2</sub> cylinders.*

***It requires 1/2 pound CO<sub>2</sub> to dispense 1/2 barrel of beer at 38°F with 15 pounds pressure on barrel.***

### PRESSURE ADJUSTMENT ON CO<sub>2</sub> REGULATOR

#### Increasing Pressure:

1. Close regulator shut-off "C".
2. Turn regulator key "B" clockwise and make setting.
3. Tap gauge for accurate reading.
4. Open regulator shut-off "C" and draw beer.

#### Decreasing Pressure:

1. Close regulator shut-off "C".
2. Untap barrel at "D" and to bleed line, activate tap handle. Leave in open position.
3. Slowly open regulator shut-off "C" and simultaneously turn regulator key counter-clockwise to zero reading.
4. Close regulator shut-off "C" and set pressure by turning regulator key clockwise. Check setting by opening and closing valve "C".
5. Close tap head "D". (put in "OFF" position)
6. Tap barrel at "D" and open regulator shut-off "C".

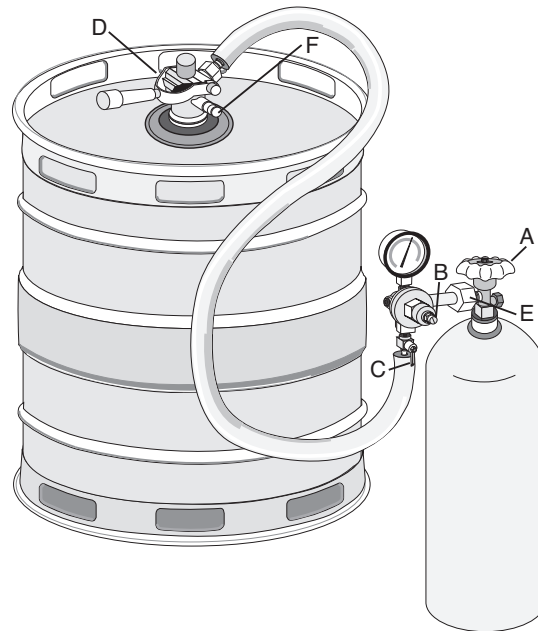

MAINTENANCE, CARE & CLEANING

## CLEANING BAR SYSTEM

Draught dispensers, regardless of design, must be cleaned at least every two weeks. Flushing your draught dispenser with water only is not enough.

**NOTE**

Use cleaners approved by your beer supplier and follow their instructions. If you are using the cleaning kit purchased from TRUE follow these instructions:

Exactness cleanliness should be constantly maintained in your dispenser so that your draught beer will be at its best when served. Although the beer in the barrel is in excellent condition, it can become less satisfying as it is drawn through the beer line and faucet if they are not kept clean.

**Prepare Solution:**

- Add 1/2 ounce (19 grams) of line cleaning powder to each quart of water, cold or warm.

**Cleaning:**

1. Disconnect tap from barrel. Remove beer faucet with spanner wrench unscrew handle and remove valve assembly (fig. 1).
2. Put tap and faucet parts in a bucket with cleaning solution to soak.
3. Use small brush to clean beer faucet parts (fig. 2).
4. Rinse parts thoroughly.

5. Fill pump bottle with DBK solution.
6. Attach hose from pump bottle to beer column tap outlet (be sure rubber gasket is in place to prevent leakage) - allow tap to drain in bucket (fig. 3).
7. Pump solution (2-3 times from bottle through the line until it starts to flow out the beer line.

**Wait 10 minutes while cleaning solution works on the lines.**

8. Pump excess solution through lines.
9. Rinse bucket, pump bottle and hose thoroughly with clean cool water.
10. Fill pump bottle with clean cool water and pump through lines until water runs clear.
11. When crystal clear water comes through, you're ready to assemble and reattach faucet and re-tap the barrel.
12. Draw the water from the beer line; now you're ready to serve brewery fresh, golden beer.

**NOTE**

Keeping your dispenser and all its parts clean and odor free will help you to serve beautiful foam topped glasses of delicious satisfying draught beer.

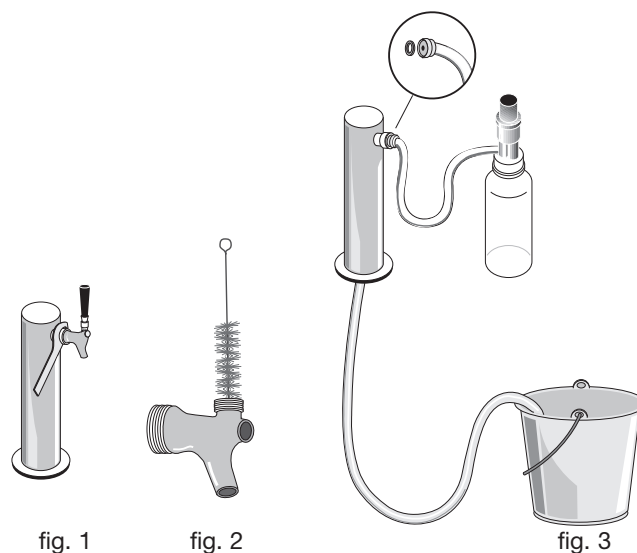
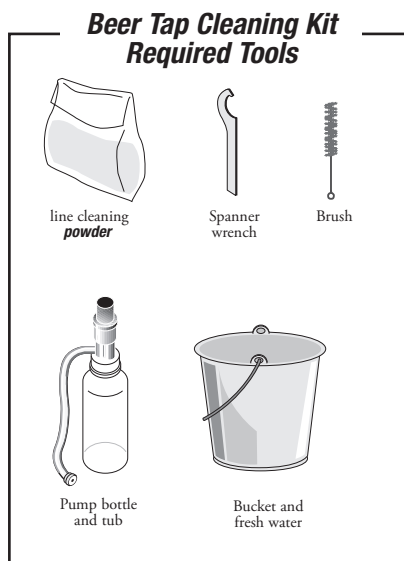

## **CLEANING THE CONDENSER COIL**

When using electrical appliances, basic safety precautions should be followed, including the following:

### **REQUIRED TOOLS**

- Phillips Screwdriver
- Stiff Bristle Brush
- Adjustable Wrench

### **STEP 1**

Disconnect power to unit.

### **STEP 2**

Take off lower grill assembly by removing all screws.

### **STEP 3**

Remove bolts anchoring compressor assembly to frame rails and carefully slide out. (tube connections are flexible)

### **STEP 4**

Clean off accumulated dirt from condensing coil with a stiff bristle brush.

### **STEP 5**

Lift cardboard cover above fan at plastic plugs and carefully clean condenser coil and fan blades.

### **STEP 6**

After brushing condenser coil vacuum dirt from coil, and interior floor.

### **STEP 7**

Replace cardboard cover. Carefully slide compressor assembly back into position and replace bolts.

### **STEP 8**

Reinstall louver assembly onto unit with appropriate fasteners and clips. Tighten all screws.

### **STEP 9**

Connect unit to power and check to see if condenser is running.

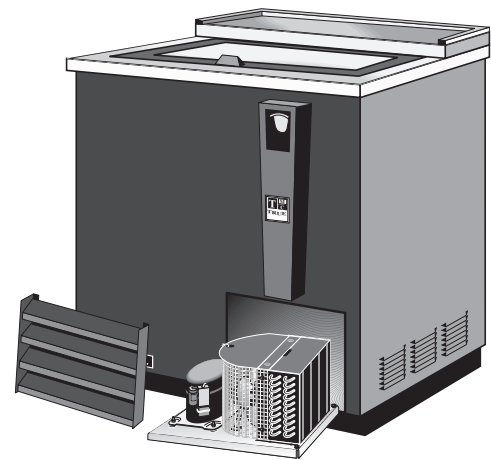
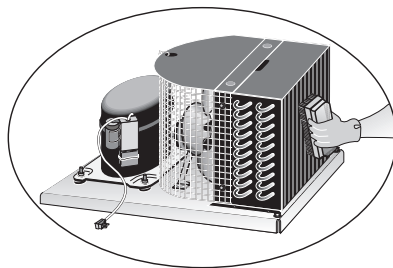
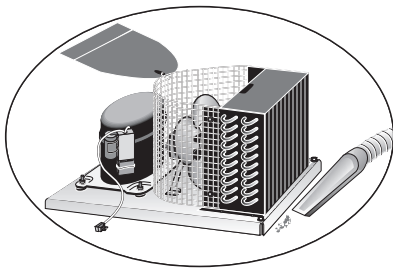

## **IMPORTANT WARRANTY INFORMATION**

**Condensers accumulate dirt and require cleaning every 30 days. Dirty condensers result in compressor failure, product loss, and lost sales... which are not covered by warranty.**

**If you keep the Condenser clean you will minimize your service expense and lower your electrical costs. The Condenser requires scheduled cleaning every thirty days or as needed.**

**Air is pulled through the Condenser continuously, along with dust, lint, grease, etc.**

**A dirty Condenser can result in NON-WARRANTED part & Compressor Failures, Product Loss, and Lost Sales.**

**Proper cleaning involves removing dust from the Condenser. By using a soft brush, or vacuuming the Condenser with a shop vac, or using CO2, nitrogen, or pressurized air.**

**If you cannot remove the dirt adequately, please call your refrigeration service company.**

**On most of the reach-in units the condenser is accessible in the rear of the unit. You must remove the cabinet grill to expose the Condenser.**

**The Condenser looks like a group of vertical fins. You need to be able to see through the condenser for the unit to function at maximum capacity. Do not place filter material in front of condensing coil. This material blocks air-flow to the coil similar to having a dirty coil.**

**THE CLEANING OF THE CONDENSER IS NOT COVERED BY THE WARRANTY!**

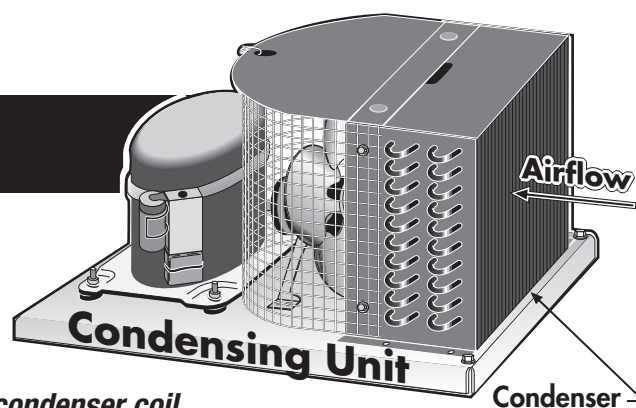

### **HOW TO CLEAN THE CONDENSER:**

- 1. Disconnect the electrical power to the unit.**
- 2. Remove the louvered grill.**
- 3. Vacuum or brush the dirt, lint, or debris from the finned condenser coil.**
- 4. If you have a significant dirt build up you can blow out the condenser with compressed air. (CAUTION MUST BE USED to avoid eye injury. Eye protection is recommended.)**
- 5. When finished be sure to replace the louvered grill. The grill protects the condenser.**
- 6. Reconnect the electrical power to the unit.**

**If you have any questions, please call TRUE Manufacturing at 636-240-2400 or 800-325-6152 and ask for the Service Department. Service Department Availability Monday-Friday 7:30 a.m. to 6:00 p.m. and Saturday 8:00 a.m. to 12:00 p.m. CST.**

MAINTENANCE, CARE & CLEANING

**STAINLESS STEEL EQUIPMENT CARE AND CLEANING**

**CAUTION: Do not use any steel wool, abrasive or chlorine based products to clean stainless steel surfaces.**

Stainless Steel Opponents

There are three basic things which can break down your stainless steel's passivity layer and allow corrosion to rear its ugly head.

- 1) Scratches from wire brushes, scrapers, and steel pads are just a few examples of items that can be abrasive to stainless steel's surface.
- 2) Deposits left on your stainless steel can leave spots. You may have hard or soft water depending on what part of the country you live in. Hard water can leave spots. Hard water that is heated can leave deposits if left to sit too long. These deposits can cause the passive layer to break down and rust your stainless steel. All deposits left from food prep or service should be removed as soon as possible.
- 3) Chlorides are present in table salt, food, and water. Household and industrial cleaners are the worst type of chlorides to use.

8 steps that can help prevent rust on stainless steel:

1. Using the correct cleaning tools  
Use non-abrasive tools when cleaning your stainless steel products. The stainless steel's passive layer will not be harmed by soft cloths and plastic scouring pads. Step 2 tells you how to find the polishing marks.
2. Cleaning along the polish lines  
Polishing lines or "grain" are visible on some stainless steels. Always scrub parallel to visible lines on some stainless steels. Use a plastic scouring pad or soft cloth when you cannot see the grain.
3. Use alkaline, alkaline chlorinated or non-chloride containing cleaners  
While many traditional cleaners are loaded with chlorides, the industry is providing an ever increasing choice of non-chloride cleaners. If you are not sure of your cleaner's chloride content contact your cleaner supplier. If they tell you that your present cleaner contains chlorides, ask if they have an alternative. Avoid cleaners containing quaternary salts as they can attack stainless steel, causing pitting and rusting.
4. Water Treatment  
To reduce deposits, soften the hard water when possible. Installation of certain filters can remove corrosive and distasteful elements. Salts in a properly maintained water softener can be to your advantage. Contact a treatment specialist if you are not sure of the proper water treatment.
5. Maintaining the cleanliness of your food equipment  
Use cleaners at recommended strength (alkaline, alkaline chlorinated or non-chloride). Avoid build-up of hard stains by cleaning frequently. When boiling water with your stainless steel equipment, the single most likely cause of damage is chlorides in the water. Heating any cleaners containing chlorides will have the same damaging effects.
6. Rinse  
When using chlorinated cleaners you must rinse and wipe dry immediately. It is better to wipe standing cleaning agents and water as soon as possible. Allow the stainless steel equipment to air dry. Oxygen helps maintain the passivity film on stainless steel.
7. Hydrochloric acid (muriatic acid) should never be used on stainless steel
8. Regularly restore/passivate stainless steel

## **STAINLESS STEEL EQUIPMENT CARE AND CLEANING**

---

### ***Recommended cleaners for certain situations / environments of stainless steel***

- A) Soap, ammonia and detergent medallion applied with a cloth or sponge can be used for routine cleaning.
- B) Arcal 20, Lac-O-Nu Ecoshine applied provides barrier film for fingerprints and smears.
- C) Cameo, Talc, Zud First Impression is applied by rubbing in the direction of the polished lines for stubborn stains and discoloring.
- D) Easy-off and De-Grease It oven aid are excellent for removals on all finishes for grease-fatty acids, blood and burnt-on foods.
- E) Any good commercial detergent can be applied with a sponge or cloth to remove grease and oil.
- F) Benefit, Super Sheen, Sheila Shine are good for restoration / passivation.

***NOTE:***

***The use of stainless steel cleaners or other such solvents is not recommended on plastic parts. Warm soap and water will suffice.***

## **LIGHT BULB REPLACEMENT (IDL) INTEGRATED DOOR LIGHTING**

Be careful when removing the light bulb. Please be aware of your local ordinances in disposing old florescent bulbs. These bulbs should be disposed in a safe and correct manner.

**WARNING**

*When replacing a light bulb make sure power to the unit is either turned off or unplugged.*



Remove the lampshield to reveal the bulb. Squeeze the sides of the lampshield at the same time pulling it away from the bulb.



The lamp holders are spring activated. Pull the top lamp holder up and push the bulb down at the same time. This will leave enough clearance to remove the bulb.



## WARRANTY INFORMATION (U.S.A & CANADA ONLY!)

**THIS WARRANTY ONLY APPLIES TO UNITS SHIPPED FROM TRUE'S MANUFACTURING FACILITIES AFTER JANUARY 1, 2013.  
PRODUCT MUST BE PURCHASED IN THE COUNTRY WHERE SERVICE IS REQUESTED.**

### THREE YEAR PARTS & LABOR WARRANTY

TRUE warrants to the original purchaser of every new TRUE refrigerated unit, the cabinet and all parts thereof, to be free from defects in material or workmanship, under normal and proper use and maintenance service as specified by TRUE and upon proper installation and start-up in accordance with the instruction packet supplied with each TRUE unit. TRUE's obligation under this warranty is limited to a period of three (3) years from the date of original installation or 39 months after shipment date from TRUE, whichever occurs first.

Any part covered under this warranty that are determined by TRUE to have been defective within three (3) years of original installation or thirty-nine (39) months after shipment date from manufacturer, whichever occurs first, is limited to the repair or replacement, including labor charges, of defective parts or assemblies. The labor warranty shall include standard straight time labor charges only and reasonable travel time, as determined by TRUE.

Warranty does not cover standard wear parts which include door gaskets, incandescent bulbs or fluorescent bulbs. Warranty also does not cover issues caused by improper installation or lack of basic preventative maintenance which includes regular cleaning of condenser coils.

### ADDITIONAL TWO YEAR COMPRESSOR WARRANTY

In addition to the Three (3) year warranty stated above, TRUE warrants its hermetically and semi-hermetically sealed compressor to be free from defects in both material and workmanship under normal and proper use and maintenance service for a period of two (2) additional years from the date of original installation but not to exceed five (5) years and three (3) months after shipment from the manufacturer.

Compressors determined by TRUE to have been defective within this extended time period will, at TRUE's option, be either repaired or replaced with a compressor or compressor parts of similar design and capacity.

The two (2) year extended compressor warranty applies only to hermetically and semi-hermetically sealed parts of the compressor and does not apply to any other parts or components, including, but not limited to: cabinet, paint finish, temperature control, refrigerant, metering device, driers, motor starting equipment, fan assembly or any other electrical component, etcetera.

### 404A/134A COMPRESSOR WARRANTY

The two year compressor warranty detailed above will be voided if the following procedure is not carefully adhered to:

1. This system contains R404A or R134A refrigerant and polyol ester lubricant. The polyol ester lubricant has rapid moisture absorbing qualities. If long exposure to the ambient conditions occur, the lubricant must be removed and replaced with new. For oil amounts and specifications please call TRUE technical service department (800-325-6152). Failure to comply with recommended lubricant specification will void the compressor warranty.

2. Drier replacement is very important and must be changed when a system is opened for servicing. A drier using XH-7 desiccant or an exact replacement solid core drier must be used. The new drier must also be the same capacity as the drier being replaced.

3. Micron level vacuums must be achieved to insure low moisture levels in the system. 500 microns or lower must be obtained.

### WARRANTY CLAIMS

All claims for labor or parts must be made directly through TRUE. All claims should include: model number of the unit, the serial number of the cabinet, proof of purchase, date of installation, and all pertinent information supporting the existence of the alleged defect.

In case of warranty compressor, the compressor model tag must be returned to TRUE along with above listed information.

Any action or breach of these warranty provisions must be commenced within one (1) year after that cause of action has occurred.

### WHAT IS NOT COVERED BY THIS WARRANTY

TRUE's sole obligation under this warranty is limited to either repair or replacement of parts, subject to the additional limitations below. This warranty neither assumes nor authorizes any person to assume obligations other than those expressly covered by this warranty.

**NO CONSEQUENTIAL DAMAGES.** TRUE IS NOT RESPONSIBLE FOR ECONOMIC LOSS; PROFIT LOSS; OR SPECIAL, INDIRECT, OR CONSEQUENTIAL DAMAGES, INCLUDING WITHOUT LIMITATION, LOSSES OR DAMAGES ARISING FROM FOOD OR PRODUCT SPOILAGE CLAIMS WHETHER OR NOT ON ACCOUNT OF REFRIGERATION FAILURE.

**WARRANTY IS NOT TRANSFERABLE.** This warranty is not assignable and applies only in favor of the original purchaser/user to whom delivered. ANY SUCH ASSIGNMENT OR TRANSFER SHALL VOID THE WARRANTIES HEREIN MADE AND SHALL VOID ALL WARRANTIES, EXPRESS OR IMPLIED, INCLUDING ANY WARRANTY OF MERCHANTABILITY OR FITNESS FOR A PARTICULAR PURPOSE.

**IMPROPER USAGE.** TRUE ASSUMES NO LIABILITY FOR PARTS OR LABOR COVERAGE FOR COMPONENT FAILURE OR OTHER DAMAGES RESULTING FROM IMPROPER USAGE OR INSTALLATION OR FAILURE TO CLEAN AND/OR MAINTAIN PRODUCT AS SET FORTH IN THE WARRANTY PACKET PROVIDED WITH THE UNIT.

**RESIDENTIAL APPLICATIONS:** TRUE assumes no liability for parts or labor coverage for component failure or other damages resulting from installation in non-commercial or residential applications.

**ALTERATION, NEGLIGENCE, ABUSE, MISUSE, ACCIDENT, DAMAGE DURING TRANSIT OR INSTALLATION, FIRE, FLOOD, ACTS OF GOD.** TRUE is not responsible for the repair or replacement of any parts that TRUE determines have been subjected after the date of manufacture to alteration, neglect, abuse, misuse, accident, damage during transit or installation, fire, flood, or act of God.

**IMPROPER ELECTRICAL CONNECTIONS.** TRUE IS NOT RESPONSIBLE FOR THE REPAIR OR REPLACEMENT OF FAILED OR DAMAGED COMPONENTS RESULTING FROM INCORRECT SUPPLY VOLTAGE, THE USE OF EXTENSION CORDS, LOW VOLTAGE, OR UNSTABLE SUPPLY VOLTAGE.

**NO IMPLIED WARRANTY OF MERCHANTABILITY OR FITNESS FOR A PARTICULAR PURPOSE:** THERE ARE NO OTHER WARRANTIES, EXPRESSED, IMPLIED OR STATUTORY, EXCEPT THE THREE (3) YEAR PARTS & LABOR WARRANTY AND THE ADDITIONAL TWO (2) YEAR COMPRESSOR WARRANTY AS DESCRIBED ABOVE. THESE WARRANTIES ARE EXCLUSIVE AND IN LIEU OF ALL OTHER WARRANTIES, INCLUDING IMPLIED WARRANTY AND MERCHANTABILITY OR FITNESS FOR A PARTICULAR PURPOSE. THERE ARE NO WARRANTIES WHICH EXTEND BEYOND THE DESCRIPTION ON THE FACE HEREOF.

**OUTSIDE U.S./CANADA:** This warranty does not apply to, and TRUE is not responsible for, any warranty claims made on products sold or used outside the United States or Canada.