



tresco 
lighting







Table of Contents



About Us.....11

Puck Lighting24

12VDC

- Pockit® Plus 1.5W26
- Power Pockit® 3W.....28
- Power Pockit® 5W.....30
- Pockit® Point.....32
- Pockit® Spot.....34
- Pockit® Adapt.....36
- 3W EquiLine Puck.....38

120V

- Pockit® 120-M.....40

Linear Lighting48

12VDC

- FineLine 2.050
- SimpLED 2.052
- Eurolinx.....54
- ELli® Series.....56
- EquiLine SimpLED.....58
- EquiLine FineLine60

120V

- T5 Trescent® LED.....62

Single Color Tape Lighting.....70

12VDC

- FlexTape®72
- Edge Emitting FlexTape®78
- EquiLine Tape LED.....79
- 12VDC COB FlexTape®82

24VDC

- 24VDC COB FlexTape®84

Tunable Tape Lighting.....91

12VDC

- 12VDC White Tunable FlexTape®92

24VDC

- 24VDC White Tunable FlexTape®94

12VDC

- 12VDC RGB Balance Tunable FlexTape®96

24VDC

- 24VDC RGB Balance Tunable FlexTape®98
- 24VDC RGB Standard Tunable FlexTape®100

Extrusions105

- Infinex.....106

Panel Lighting.....118

12VDC

- Etch.....120

24VDC

- Snap128

Specialty Series133

12VDC

- Stax.....134
- Ascent.....136
- 12VDC Dual USB Charging Station.....138

Components141

- Power Supplies142
- Controllers.....150
- Install Accessories.....164

Battery.....168

Battery

- Alpha170
- Fit171

[Sales Support on page 174](#)



For overview and installation videos on many of our products visit: trescolighting.com/videos

COMPLIMENTARY

Layout Design Services

The increasingly popular application of LED lighting is new to many design professionals. Let our Lighting Layout Assistance Program guide you in specifying the ideal product and wiring schematic for your next residential or commercial project.

Typical Setup:

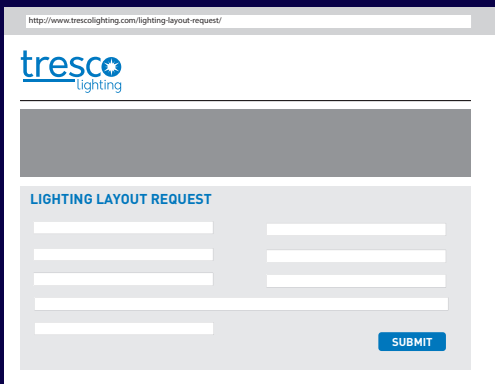

Visit: trescolighting.com/layout



Fill out the form and upload your drawings.

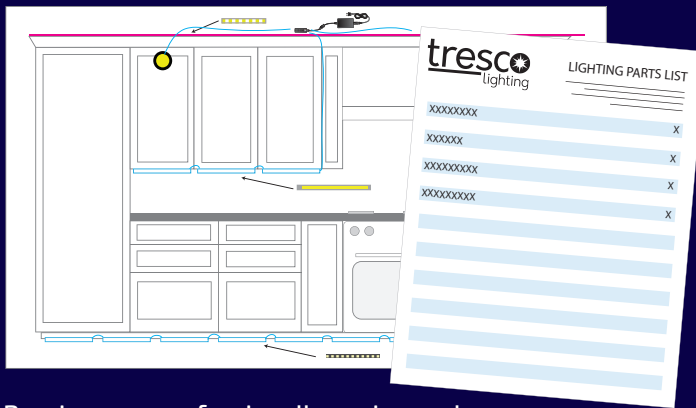

Receive your professionally engineered schematic and matching parts list.

GET STARTED TODAY >>>

trescolighting.com/layout

Product Information

Product Color Finishes

Tresco's lighting products are available in eight standard color finishes: White, Black, Chrome, Gold, Nickel, Antique Brass, Aluminum and Oil-Rubbed Bronze. Please refer to the individual Product Sections for color availability of each product.

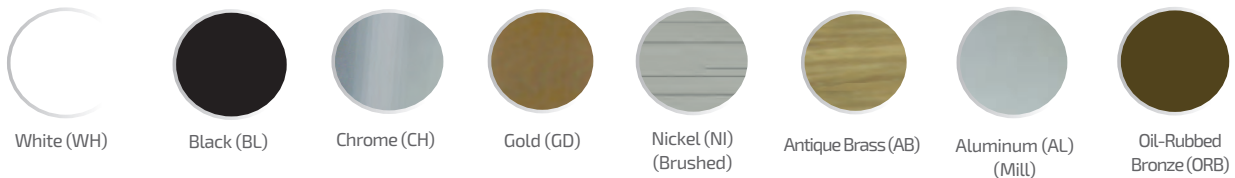

ETL, UL, and QPS-Testing, Inspection and Certification

- ETL is the largest worldwide
- UL is the largest in the USA
- Both are Nationally Recognized Testing Laboratories (NRTL) as recognized by OSHA
- Both are recognized by local inspectors throughout North America
- No mark is better than the other



Tresco Products Tested and Certified for Canada and the United States

ETL or UL marks serve as proof of product compliance to Canadian and U.S. standards. When products bear these marks, this indicates to the consumer that the products have passed a complete and thorough set of tests and certification requirements.



All TRESKO® lighting systems carry UL, ETL or QPS safety certifications. In addition, a majority of our individual lighting components (lights, power supplies, and accessories) are also registered and certified by ETL and/or UL.



UL's Recognized Component Mark

The UL Recognized Component Mark is used on components that are a part of larger products or systems. It is certified by UL to both Canadian and U.S. requirements.



CE Mark

CE Marking permits a product to be sold throughout the European Union. It is a conformity mark noting the product complies with all applicable European Directives.

* The ETL Mark is a registered trademark of Intertek.
The UL Mark and Recognized Component Mark are registered trademarks of Underwriters Laboratories Inc.
All product dimensions and specifications are subject to change without prior notice.

Lighting 101

Diode Life:

LEDs fade as opposed to abruptly burning out. "End of Life" refers to the number of hours until the LED has completely faded out, although it will have been too dim to use for many hours leading up until that point. "Useful Life", on the other hand, refers to the number of hours until the LED reaches 70% of its initial light output, which is a much more practical indicator for the consumer (defined as L70).

50,000 Hours = 17 Years (8 hours a day)

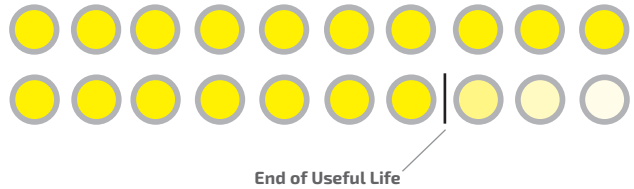

Color Consistency:

LEDs, as a natural result of the manufacturing process, have inconsistent color from one diode to the next. Top brand LED suppliers, like the ones used by Tresco, combat this by means of a process known as "binning" - inspecting each individual diode and matching them to ensure consistency.

Tresco:



Cheap LEDs:



Lumen Output:

Lumen is the measure of visible light output emitted from a fixture. For under cabinet lighting, where the goal is to illuminate a workspace to perform specific tasks, the brighter, the better. For soffit, toe kick or other accent lighting, a moderate output is better.

TASK: 150+ LUMENS

ACCENT: UNDER 150 LUMENS

Beam Spreads:

Using puck lights with tight beam spreads under wall cabinets can create unsightly dark spots on the backsplash between lights. Beam spreads of 90 degrees or greater will reduce the dark spots. For spotlight applications, such as in-cabinet or display lighting, a beam spread of 20-40 degrees is desirable.

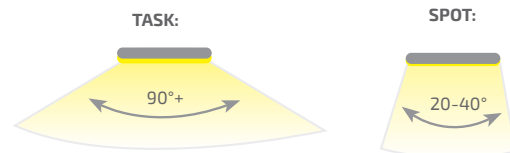

Color Temperature

Color temperature is the rating a particular color renders on the Kelvin scale. These color temperatures alter how an object or room is perceived when illuminated, and Tresco offers a wide range to choose from. To find the appropriate color temperature for your application, please reference the table below:

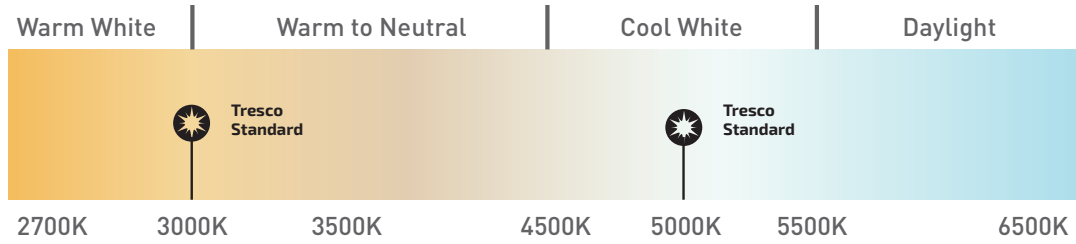

2700K
Warm White
 Recommended for Earth Tones
 Mimics Incandescent
 Highlights Wood Grains
 Primarily for Residential Use
 Not Recommended for White



3000K
Warm White
 Recommended for Earth Tones
 Slightly "Whiter" Than Incandescent
 Highlights Wood Grains
 Primarily for Residential Use
 Not Recommended for White



3500K
Warm to Neutral
 Transitional Between Warm and Cool
 Will Equally Highlight Earth Tones and Cool Tones
 Recommended for Residential and Commercial Use
 Will Give White an Off-White Look



5000K
Cool White
 Highlights Whites/Blue/Cool Tones
 Primarily For Commercial Use
 Recommended for White
 Not Recommended for Wood Grain/Earth Tones



6500K
Daylight
 Has Bluish Tint (Sky Color)
 Primarily Used for Backlighting/Signs
 Not Recommended for Residential Use

What is Luniform?



luniform (loo-nuh-fawrm) n.
The technology to eliminate "dotted" appearances and reduce unwanted glare within light emitting diode fixtures.

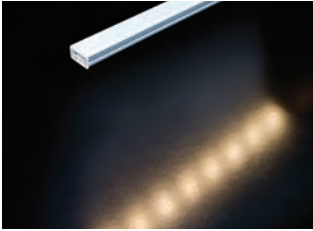

"Dotted" appearance



Luniform



Eurolinx

Secondary Optics

Secondary optics are lighting components uniquely designed to diffuse LED diodes and reduce glare, such as special lenses and proprietary films.

Diode Technology

Diode technology allows for up to 10X the amount of LED diodes on a single circuit board or substrate, resulting in greater light output and a uniform beam spread.



Power Pockit® 5W

Who We Are



Leader in LED Lighting

Tresco® Lighting is the leader in premiere lighting solutions for store fixtures, commercial applications, residential cabinetry, laboratory and hospitality furniture. With over 30 years of "Innovation Through Illumination" we proudly design and manufacture a full line of superior quality LED lighting options that are UL/ETL listed. Tresco® Lighting is the trusted brand for all your project needs.

Tresco® was founded in 1989 to meet a growing demand for quality cabinet and casework lighting. In 1992, we designed and offered the first UL-listed, under cabinet track lighting system in North America. This ingenuity and success led to the rapid development and expansion of product lines targeting different segments of business. 30 years later, our goal remains the same: Provide innovative, functional and design savvy products for the office, laboratory, hospitality, furniture, store fixture, millwork and kitchen industries. We welcome you to browse our catalog and learn more about our company and product offering.

The Company We Keep

We are members in good standing with the most respected names in the business. Our customers can be confident that they're dealing with a professional, reputable, and reliable leader in the LED lighting industry.



History

1989

Tresco® International opens operations

1993

Launched first product - Under Cabinet Track System UL issues first safety listing ever for a non-wall or ceiling track system to Tresco®

1996

Launched Lumaflex, one of the first rope lighting systems in the USA

2000

Chris Tress joins Tresco® and becomes general manager

2003

Construction on a modern facility begins that doubles our size

2008

Patent issued for Elli® Linkable Light System

2009

Patent issued for Modular Light Rail Light System

2010

Patent issued for iMAGine® Shelf Light System

2011

Tresco® acquired by Rev-A-Shelf®, LLC

2013

Patent issued for SimpLED Linear LED System

2014

Construction of new 300,000 square foot building

2015

Introduced Infinex, a custom extrusion lighting solution

2016

Introduced FREEDiM Series of wireless controllers

2017

Patents issued for Infinex extrusion system and FREEDiM wireless controllers

2017

Snap panel lighting wins KBIS "Best of Show"

2019

Patent issued for Etch panel



Tresco® International launches first product. (Halogen Track Light, 1993)

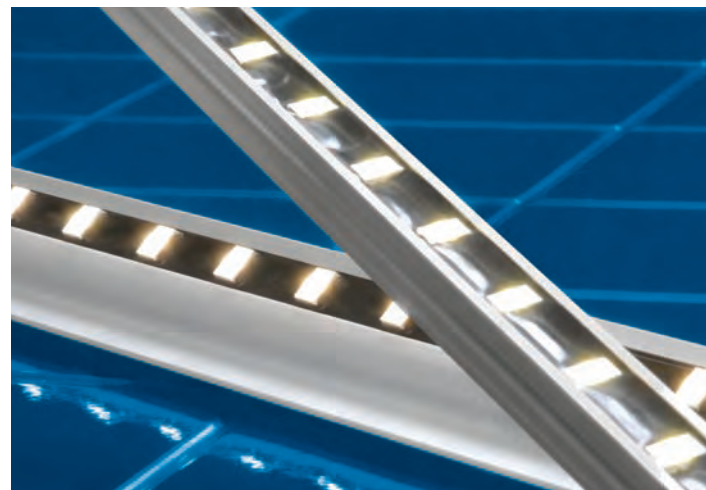

First of many U.S. patents awarded to Tresco®. (Elli® Series, 2008)



Tresco® launches new Luniform LED Technology. (SimpLED 2.0, 2014)

What We Do

Linear Lighting

Tresco® linear or "strip" lights are available in a range of styles, price points, outputs, and color temperatures.



Pocket® Lighting

Tresco Pocket® or "puck" lights are available in a variety of configurations. Large or small, spot or accent, metal or plastic, linkable or non-linkable, Tresco® has a "Pocket®" light for you.



Panel Lighting

Take your designs to new levels with panel lighting. From countertops and shelves to artwork and signs, backlighting provides both decorative and utility lighting in one application.

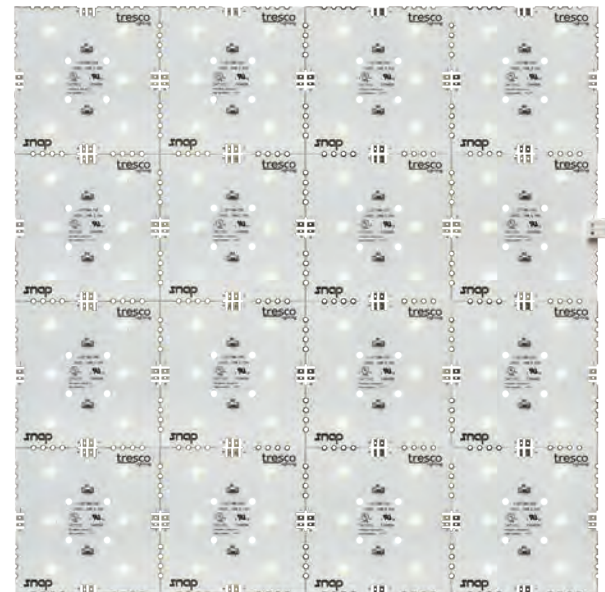

Flexible Lights

With Tresco®'s FlexTape®, you can have the flexibility you need without sacrificing the quality you demand. Whether Backlighting a sign, edge lighting a display, or accent lighting Air Force One, Tresco®'s line of flexible lights are all you need.





Store Fixtures

Tresco® products are the perfect addition to your store fixture lighting. If we don't stock what you need, we can custom design it for you. Tresco® Lighting is the solution.



Commercial Furniture

From desks to shelves, high quality Tresco® Lighting products provide ideal lighting for the office at a low price.



Hospitality

Whether the relaxing glow of a hotel room or the inviting radiance of a restaurant, lighting is an essential part of our lives and especially important when creating an atmosphere. Tresco® is here to help you create an enjoyable guest experience, accentuate your brand, and save you money.



Residential Cabinets

Adding lighting to your residential cabinetry is easier than ever with Tresco® Lighting. Our standard power supply and connectors work with the entire line of LED lighting — no more trying to find what connector works with what power supply. Tresco® Lighting is easy as 1-2-3.



Institutional

Warrantied, safety tested, and built to withstand demanding environments, Tresco® products are ideal for institutional locations. Whatever your application, our lights provide optimum task visibility at a minimal operational cost for cafeterias, libraries, hospitals, or laboratories.



Residential Furniture

Incorporating lighting into your furniture raises the bar on the consumer experience for your brand. Worried about safety? So are we. That is why Tresco® Lighting products are UL or ETL listed.

Why Choose Us



Quality

Superior components ensure Tresco® lights are brighter and wider light spread than the competition. We use world-renowned suppliers who employ static and dust-free clean rooms, proper binning, and use of high-grade phosphors to achieve efficiency, high lumen, and color consistency.

When it comes to LED, the diode makes the difference. That is why we use brands like Nichia and Cree.



Independent Testing

We don't just say our lights are better — we prove it. Independent testing certification available for TM21, LM80, and LM79 photometrics to provide specification charts. Charts are printed next to our lights for proper specification of our products.

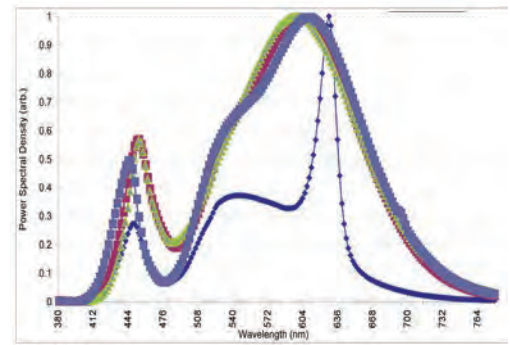

Safety Listings

At Tresco®, safety is a top priority. All of our products carry UL, ETL or QPS safety certifications for the United States and Canada.

CE marking permits a product to be sold throughout the European Union. It is a conformity mark noting the product complies with all applicable European directives.



Why Choose Us

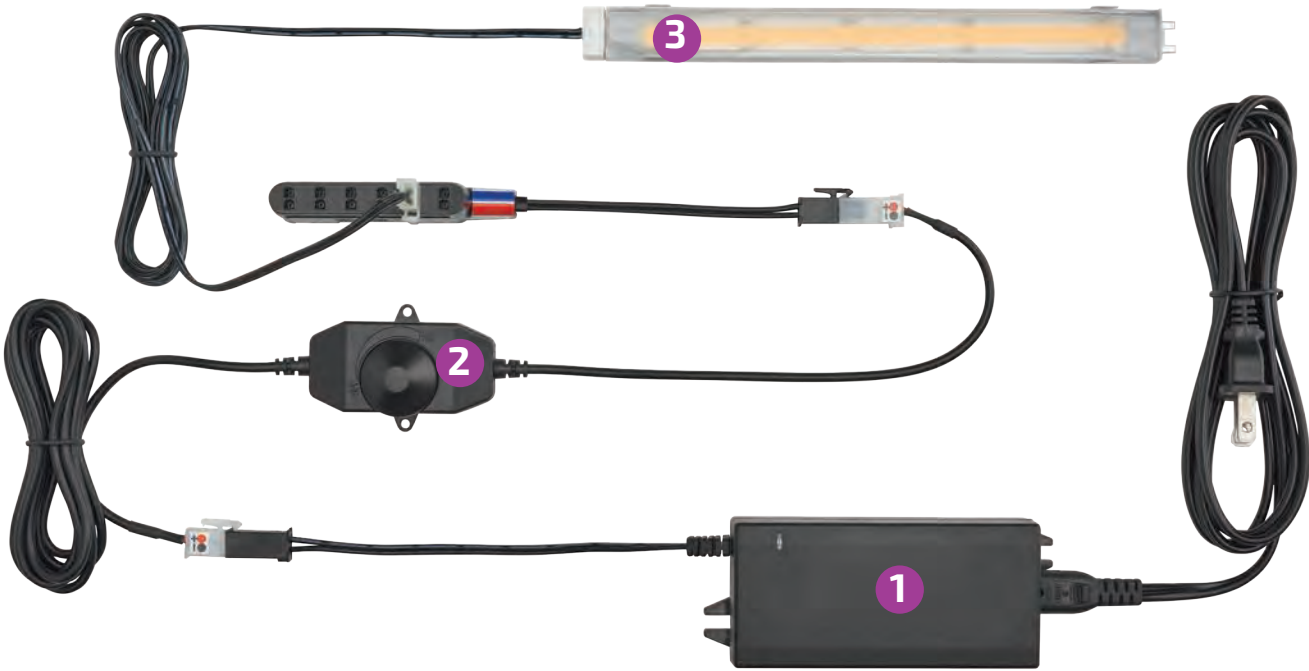

We Make Lighting Easy

Easy as 1 - 2 - 3.

- 1) Universal power supply
- 2) Controller connects to the power supply
- 3) Light fixture connects to the controller

Universal System

Tresco®'s in-house design and manufacturing teams create LED lights to work with one power source. Other products require different power supplies for different lights, but Tresco®'s LED lights are designed to work with a single 12VDC or 24VDC power supply. No more wiring nightmares.



In-House Design

We are not your typical lighting company. From art to part, we design and manufacture custom lighting solutions based on your specific needs.



Luniform

Luniform is the technology to eliminate "dotted" appearances and reduce unwanted glare within light emitting diode fixtures.

See Page 10 for more information.

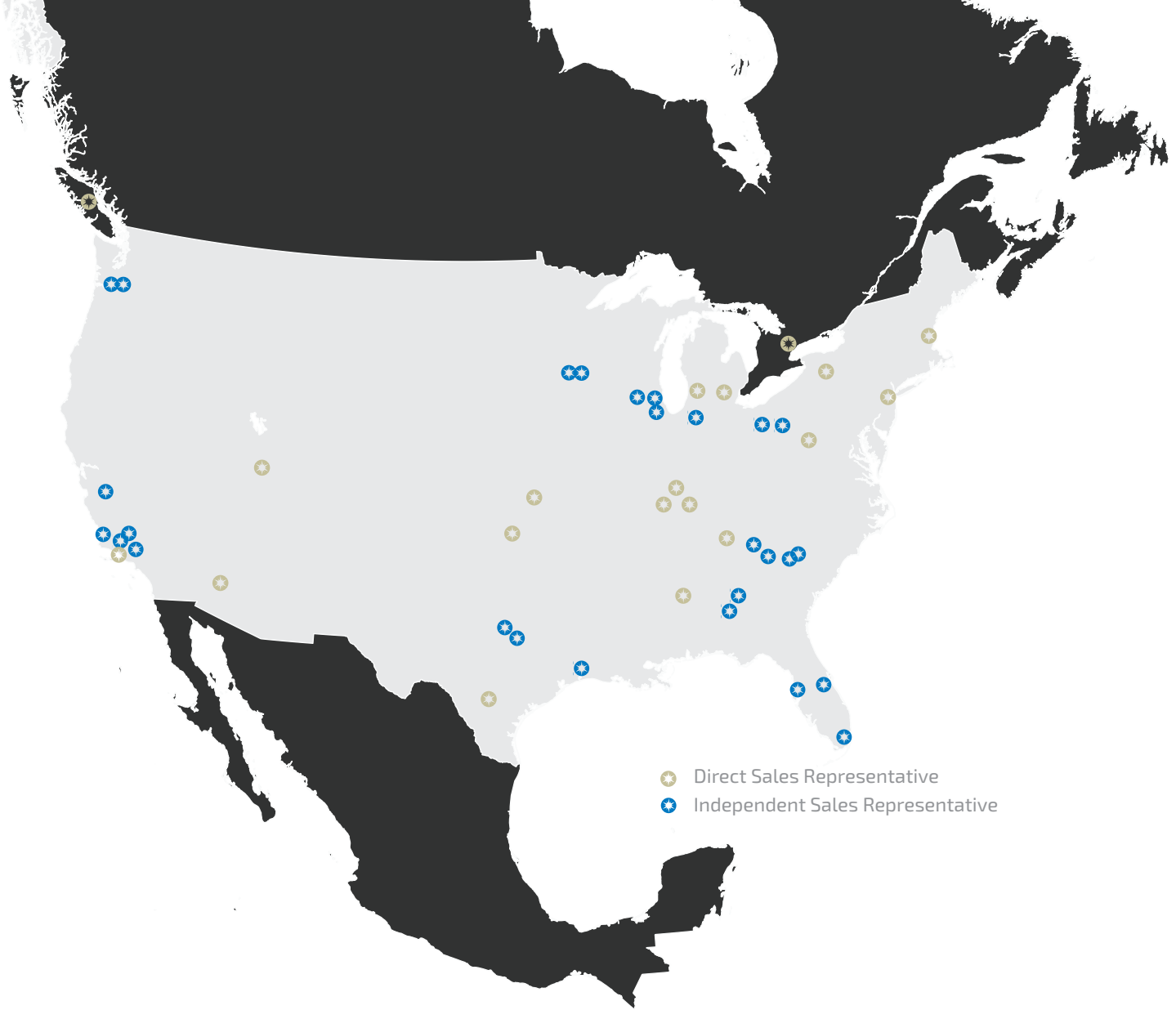

Distribution Network

Tresco® products are stocked with over 100 distributors in North America, giving you same day or next day delivery.

OEM Network

Our OEM network includes some of the largest and most respected manufacturers in the business. This helps us achieve economies of scale that result in cost savings for you.

Our Team

Representatives from the Tresco® Lighting Sales and Customer Service teams are in the field and ready to help you find the right product for your application.





12VDC
120V

PUCK

Pockit® Plus 1.5W

12VDC



1.5W	115 Lumens	
<p>Pockit® Plus features clean and simple lines PLUS cutting-edge bulb technology that provide powerful, bright light without the energy consumption and heat. Performance and effortless installation for recess or surface mounting all at a competitive price – that's the power of PLUS.</p>		

Features:

Slim Profile – 1/4" (6 mm)

90° beam spread

Durable milled aluminum construction

Recess or surface mount

Typical Applications:

Displays

Mid-level flood light

Interior cabinets

Under cabinets

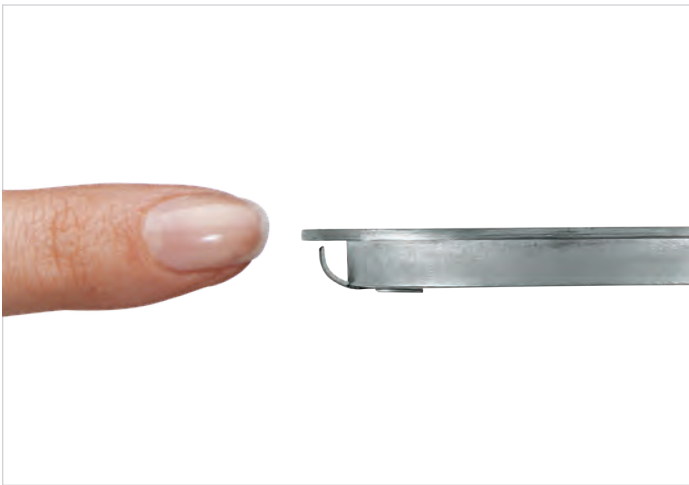

Thin profile: Just 1/4" (6 mm) depth when recessing
3/8" (9.5 mm) when surface mounting



Available in 4 finishes, with clear lens



Surface mount ring included



Available Finishes:

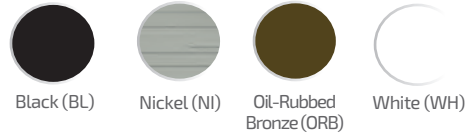

Dimensions:

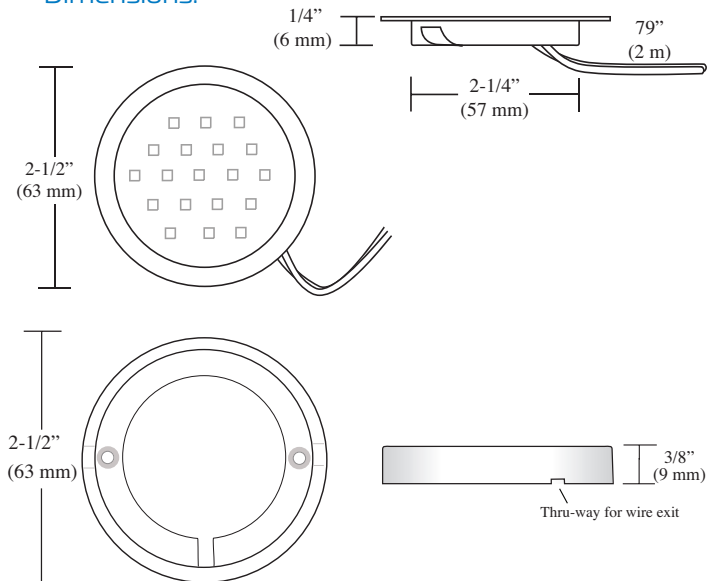

Typical Setup:

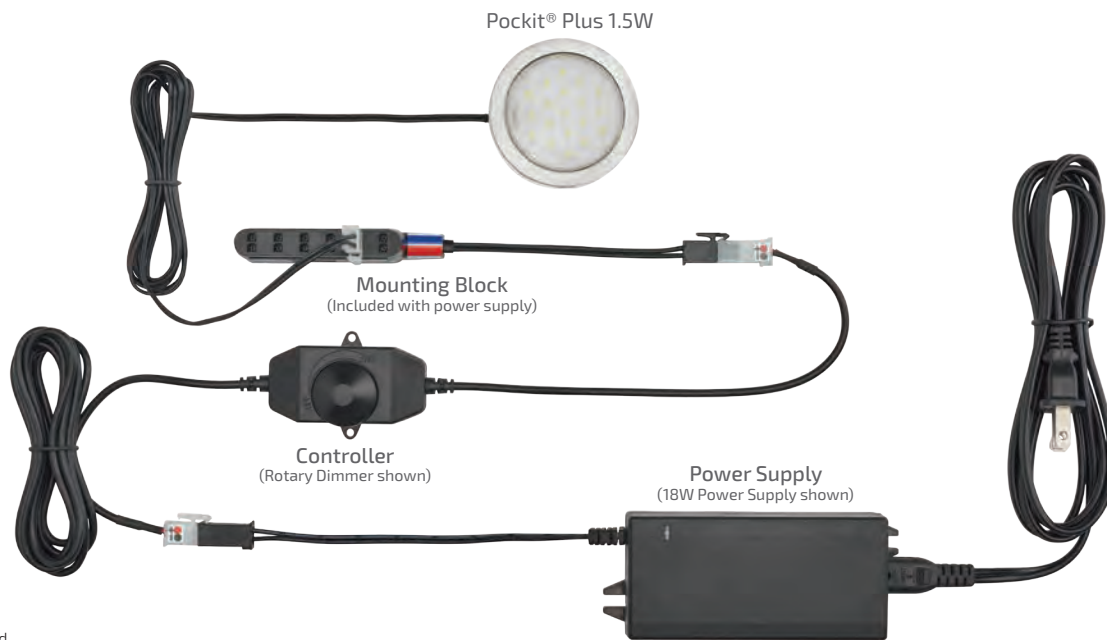

- Required
- Optional

Accessories:



● Required

Power Supplies
see power supply section

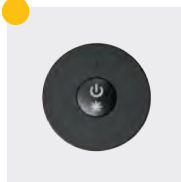

● Optional

Controllers
see controller section



● Optional

Starter Cord / Link Cords
see pg. 165 under starter extension cords

Specifications:

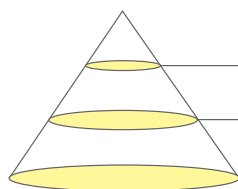
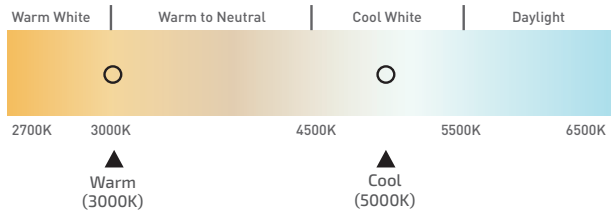
Wattage	Lumens	Efficacy (lm/W)	Input Voltage	Diode Life	Max Per 60W Power Supply	Mounting	Warranty	Beam Angle												
1.5W	115	77	12VDC	25,000 Hours	40 Fixtures	Recess/ Surface	3 Year													
Photometric Data					Color Temperature															
 <table border="1" style="margin-left: 20px;"> <thead> <tr> <th>Height</th> <th>Light Output</th> <th>Beam Area</th> </tr> </thead> <tbody> <tr> <td>1ft (.3 m)</td> <td>44.50Fc (479lx)</td> <td>2.5ft L x 2.5ft W (.8 m L x .8 m W)</td> </tr> <tr> <td>3ft (.9 m)</td> <td>4.95Fc (53.3lx)</td> <td>7.6ft L x 7.6ft W (2.3 m L x 2.3 m W)</td> </tr> <tr> <td>6ft (1.8 m)</td> <td>1.24Fc (13.3lx)</td> <td>15.2ft L x 15.2ft W (4.6 m L x 4.6 m W)</td> </tr> </tbody> </table> <p style="text-align: right; font-size: small;">L-POC-1LED5FR-C Tested</p>					Height	Light Output	Beam Area	1ft (.3 m)	44.50Fc (479lx)	2.5ft L x 2.5ft W (.8 m L x .8 m W)	3ft (.9 m)	4.95Fc (53.3lx)	7.6ft L x 7.6ft W (2.3 m L x 2.3 m W)	6ft (1.8 m)	1.24Fc (13.3lx)	15.2ft L x 15.2ft W (4.6 m L x 4.6 m W)	 <p style="text-align: center; font-size: small;"> Warm White Warm to Neutral Cool White Daylight 2700K 3000K 4500K 5500K 6500K ▲ Warm (3000K) ▲ Cool (5000K) </p>			
Height	Light Output	Beam Area																		
1ft (.3 m)	44.50Fc (479lx)	2.5ft L x 2.5ft W (.8 m L x .8 m W)																		
3ft (.9 m)	4.95Fc (53.3lx)	7.6ft L x 7.6ft W (2.3 m L x 2.3 m W)																		
6ft (1.8 m)	1.24Fc (13.3lx)	15.2ft L x 15.2ft W (4.6 m L x 4.6 m W)																		

See page 42 for part numbers and descriptions

Power Pockit® 3W

12VDC



3W	234 Lumens	
<p>The Power Pockit® 3W is a versatile choice offering flood and task lighting that can be used for interior cabinets, under cabinets and store displays. This 3W energy efficient LED provides a crisp, uniform wash over illuminated objects.</p>		

Features:

- Slim Profile – 1/4" (6 mm)
- Wide 120° beam spread
- High output (234 lumens)
- Luniform output – no "dots"
- Durable milled aluminum construction
- Recess or surface mount

Typical Applications:

- Displays
- Store fixtures
- Interior/under cabinets
- Task lighting
- Closets (UL listed for use within closet storage spaces)

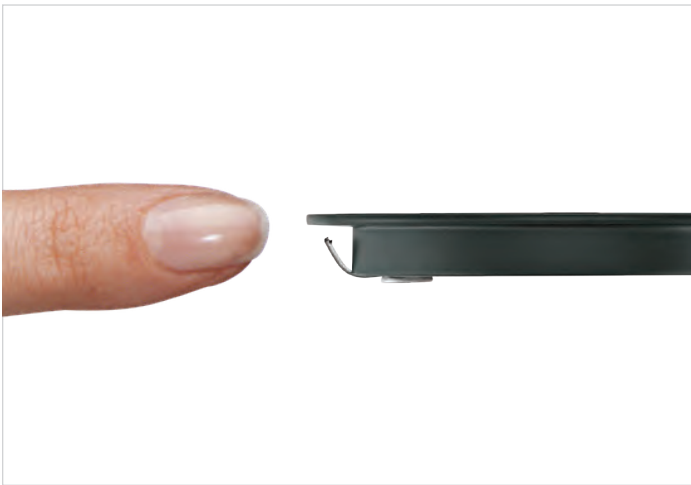

Thin profile: Just 1/4" (6 mm) depth when recessing
3/8" (9.5 mm) when surface mounting



Available Finishes:

- Antique Brass (AB)
- Black (BL)
- Chrome (CH)
- Nickel (NI)
- Oil-Rubbed Bronze (ORB)
- White (WH)

Dimensions:

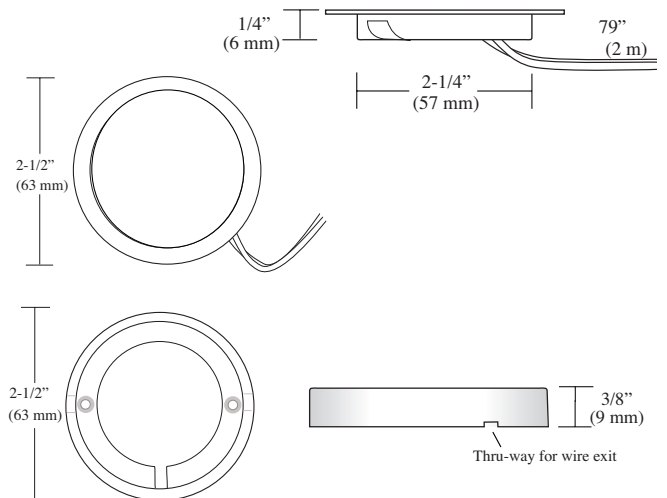

Available in multiple finishes with milk lens



Recess or surface mount

Typical Setup:

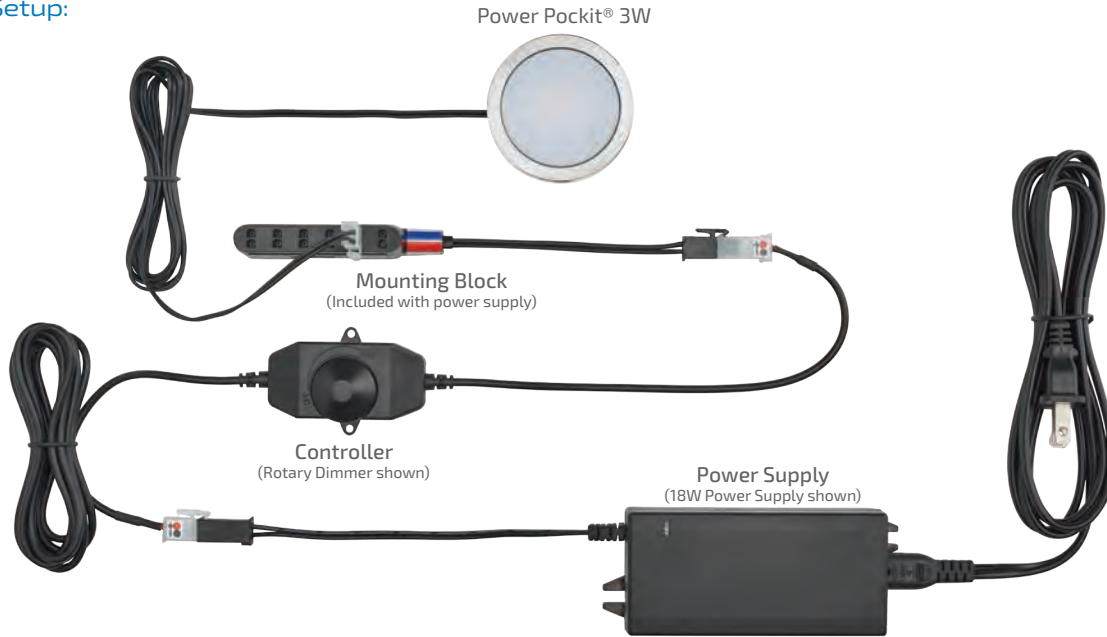

- Required
- Optional

Accessories:



● Required

Power Supplies
see power supply section



● Optional

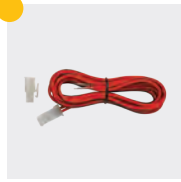

Controllers
see controller section



● Optional

Starter Cord / Link Cords
see pg. 165 under starter/extension cords

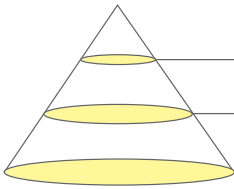
Specifications:

Wattage	Lumens	Efficacy (lm/W)	Input Voltage	Diode Life	Max Per 60W Power Supply	Mounting	Warranty	Beam Angle
3W	234	78	12VDC	50,000 Hours	20 Fixtures	Recess/ Surface	5 Year	
Photometric Data					Color Temperature			
		Height	Light Output	Beam Area	<div style="display: flex; justify-content: space-between;"> Warm White Warm to Neutral Cool White Daylight </div>  <div style="display: flex; justify-content: space-between; margin-top: 5px;"> 2700K 3000K 4500K 5500K 6500K </div> <div style="display: flex; justify-content: space-around; margin-top: 5px;"> <div style="text-align: center;">▲ Warm (3000K)</div> <div style="text-align: center;">▲ Neutral (3500K)</div> <div style="text-align: center;">▲ Cool (5000K)</div> </div>			
		1ft (.3 m)	81.30Fc (875.1lx)	3.1ft L x 3.1ft W (1 m L x 1 m W)				
		3ft (.9 m)	9.03Fc (97.2lx)	9.2ft L x 9.2ft W (2.8 m L x 2.8 m W)				
		6ft (1.8 m)	2.26Fc (24.3lx)	18.4ft L x 18.4ft W (5.6 m L x 5.6 m W)				
L-POC-3LEDSFR-C Tested								

See page 42 for part numbers and descriptions

Power Pockit® 5W

12VDC



5W	290 Lumens	100°
<p>The next generation of Power Pockit® is an astounding 25% more output than our original industry leading 3W version. With Luniform technology, 290 lumens of light are evenly distributed and eliminate the "dotted" appearance on surfaces. At only 1/4" (6 mm) depth, the Power Pockit® 5W has the the maximum illumination required in a small package.</p>		

Features:

Slim Profile – 1/4" (6 mm)

Wide 100° beam spread

High output (290 lumens)

Luniform output – no "dots"

Durable milled aluminum construction

Recess or surface mount

Typical Applications:

Displays or store furniture

Task or flood lighting

Interior cabinets/shelving

Under cabinets



Thin profile: Just 1/4" (6 mm) depth when recessing
3/8" (9.5 mm) when surface mounting



Available Finishes:

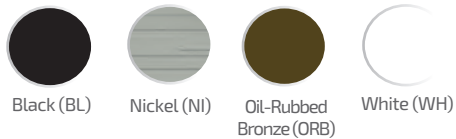

Dimensions:

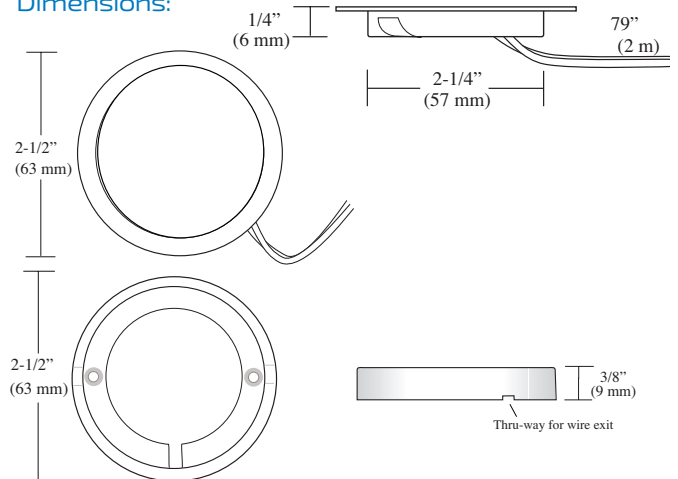

Available in multiple finishes with clear lens



Recess or surface mount

Typical Setup:

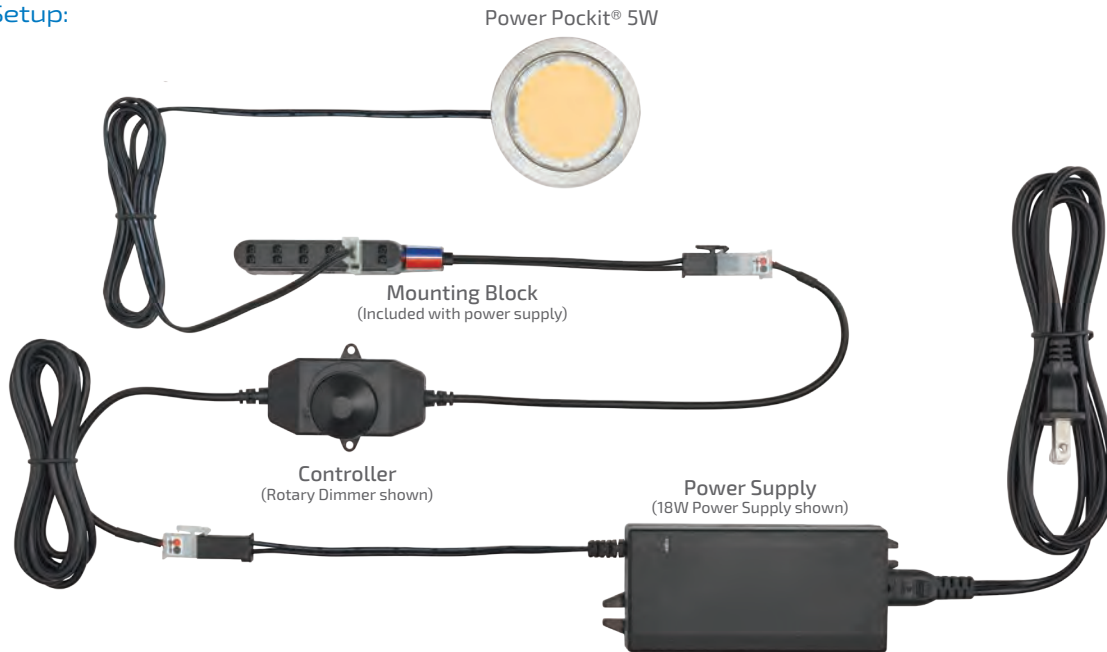

- Required
- Optional

Accessories:



● Required

Power Supplies
see power supply section

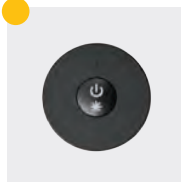

● Optional

Controllers
see controller section



● Optional

Starter Cord / Link Cords
see pg. 165 under starter/
extension cords

Specifications:

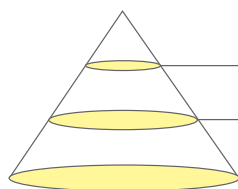
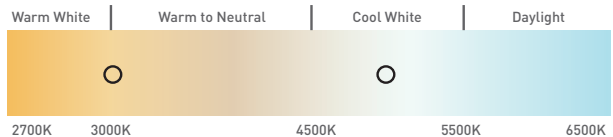
Wattage	Lumens	Efficacy (lm/W)	Input Voltage	Diode Life	Max Per 60W Power Supply	Mounting	Warranty	Beam Angle										
5W	290	58	12VDC	50,000 Hours	12 Fixtures	Recess/ Surface	5 Year											
Photometric Data					Color Temperature													
		<table border="1"> <thead> <tr> <th>Height</th> <th>Light Output</th> <th>Beam Area</th> </tr> </thead> <tbody> <tr> <td>1ft (.3 m)</td> <td>115.90Fc (1247.5lx)</td> <td>2.4ft L x 2.5ft W (.73 m L x .76 m W)</td> </tr> <tr> <td>3ft (.9 m)</td> <td>12.88Fc (138.6lx)</td> <td>7.3ft L x 7.4ft W (2.2 m L x 2.3 m W)</td> </tr> <tr> <td>6ft (1.8 m)</td> <td>3.22Fc (34.7lx)</td> <td>14.6ft L x 14.8ft W (4.5 m L x 4.5 m W)</td> </tr> </tbody> </table>	Height	Light Output	Beam Area	1ft (.3 m)	115.90Fc (1247.5lx)	2.4ft L x 2.5ft W (.73 m L x .76 m W)	3ft (.9 m)	12.88Fc (138.6lx)	7.3ft L x 7.4ft W (2.2 m L x 2.3 m W)	6ft (1.8 m)	3.22Fc (34.7lx)	14.6ft L x 14.8ft W (4.5 m L x 4.5 m W)	 <p>2700K 3000K 4500K 5500K 6500K</p> <p>Warm (3000K) Cool (5000K)</p>			
Height	Light Output	Beam Area																
1ft (.3 m)	115.90Fc (1247.5lx)	2.4ft L x 2.5ft W (.73 m L x .76 m W)																
3ft (.9 m)	12.88Fc (138.6lx)	7.3ft L x 7.4ft W (2.2 m L x 2.3 m W)																
6ft (1.8 m)	3.22Fc (34.7lx)	14.6ft L x 14.8ft W (4.5 m L x 4.5 m W)																
L-POC-5LED-C Tested																		

See page 43 for part numbers and descriptions

Pockit® Point

12VDC

1W

69 Lumens



1W Pockit® Point is the smallest LED spotlight on the market. Its small diameter and focused light are perfect for highlighting items in tight spaces.

The Pockit® Point features a very low profile with a recess depth of only 1/2" (13 mm), a collar spring for quick recessing and a 79" (2 m) starter cord attached with a loose AMP® connector for easier wire routing.



Features:

1" (25 mm) recess diameter, 1/2" (13 mm) recess depth

90° beam spread

Nearly 70 lumens of output

Spring clip mounted

Recess mount

Typical Applications:

Displays or store fixtures

Museum cases

Accent lighting

Interior cabinets and shelving

Small light boxes

Closets (UL listed for use within closet storage spaces)



Tiny 1" (25 mm) recessed diameter



Available Finishes:



Dimensions:

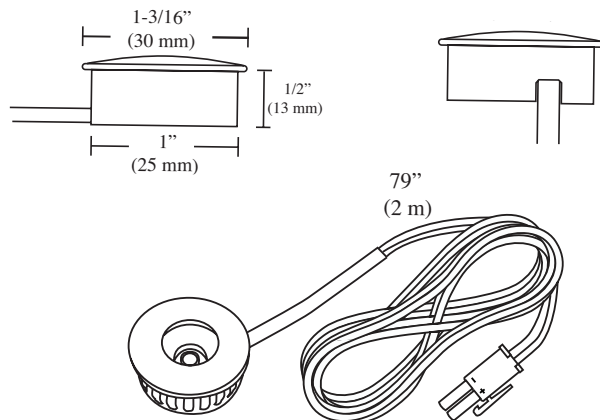

Available in 3 finishes



1-3/16" (30 mm) overall diameter

Typical Setup:

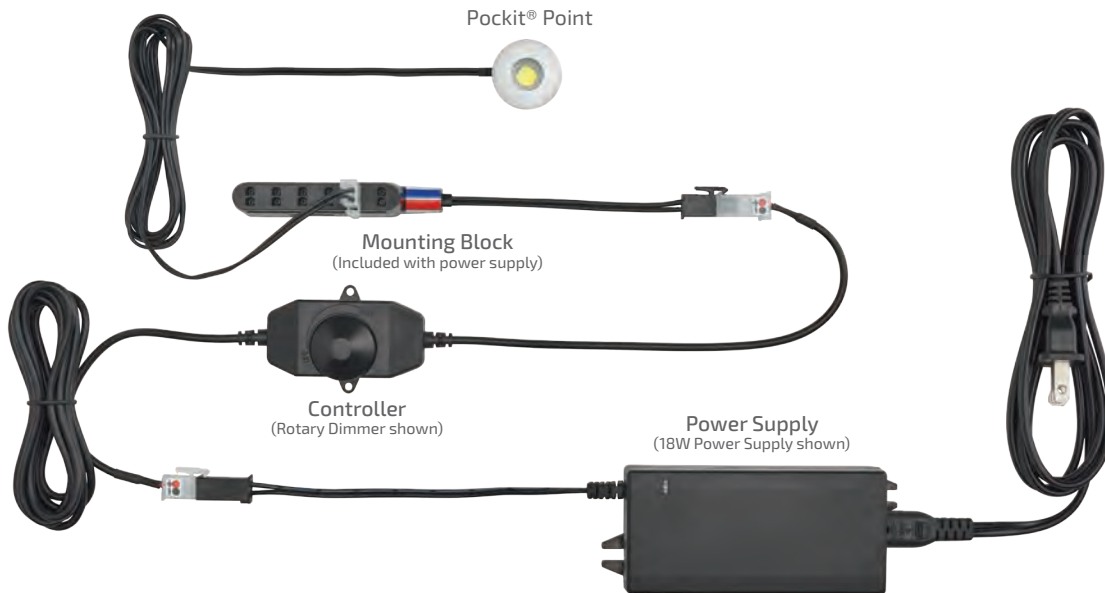

- Required
- Optional

Accessories:



Power Supplies
see power supply section



Controllers
see controller section



Starter Cord / Link Cords
see pg. 165 under starter/
extension cords

Specifications:

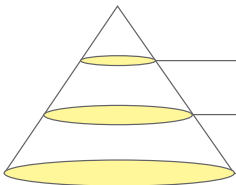
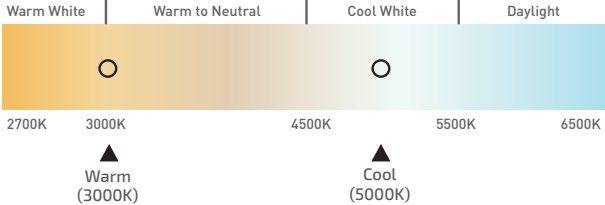
Wattage	Lumens	Efficacy (lm/W)	Input Voltage	Diode Life	Max Per 60W Power Supply	Mounting	Warranty	Beam Angle												
1W	69	69	12VDC	30,000 Hours	50 Fixtures	Recess	1 Year													
Photometric Data					Color Temperature															
 <table border="1" style="margin-left: auto; margin-right: auto;"> <thead> <tr> <th>Height</th> <th>Light Output</th> <th>Beam Area</th> </tr> </thead> <tbody> <tr> <td>1ft (.3 m)</td> <td>37.60Fc (404.7lx)</td> <td>19ft L x 1.9ft W (.58 m L x .58 m W)</td> </tr> <tr> <td>3ft (.9 m)</td> <td>4.18Fc (45lx)</td> <td>5.8ft L x 5.8ft W (1.8 m L x 1.8 m W)</td> </tr> <tr> <td>6ft (1.8 m)</td> <td>1.04Fc (11.2lx)</td> <td>11.6ft L x 11.5ft W (3.5 m L x 3.5 m W)</td> </tr> </tbody> </table> <p style="text-align: center; font-size: small;">L-LED-1EB-C Tested</p>					Height	Light Output	Beam Area	1ft (.3 m)	37.60Fc (404.7lx)	19ft L x 1.9ft W (.58 m L x .58 m W)	3ft (.9 m)	4.18Fc (45lx)	5.8ft L x 5.8ft W (1.8 m L x 1.8 m W)	6ft (1.8 m)	1.04Fc (11.2lx)	11.6ft L x 11.5ft W (3.5 m L x 3.5 m W)	 <p style="text-align: center; font-size: small;"> Warm White Warm to Neutral Cool White Daylight 2700K 3000K 4500K 5500K 6500K ▲ Warm (3000K) ▲ Cool (5000K) </p>			
Height	Light Output	Beam Area																		
1ft (.3 m)	37.60Fc (404.7lx)	19ft L x 1.9ft W (.58 m L x .58 m W)																		
3ft (.9 m)	4.18Fc (45lx)	5.8ft L x 5.8ft W (1.8 m L x 1.8 m W)																		
6ft (1.8 m)	1.04Fc (11.2lx)	11.6ft L x 11.5ft W (3.5 m L x 3.5 m W)																		

See page 43 for part numbers and descriptions

Pockit[®] Spot

12VDC

3W

298 Lumens



The 3W Pockit[®] Spot performs like a spotlight with a high focus output beam to keep countertops, kiosks and displays center stage. The fixture features an exceptionally low profile and two large springs for recess mounting in a depth of only 1-1/8" (29 mm). The 3W Pockit[®] Spot has the ability to swivel in either direction.

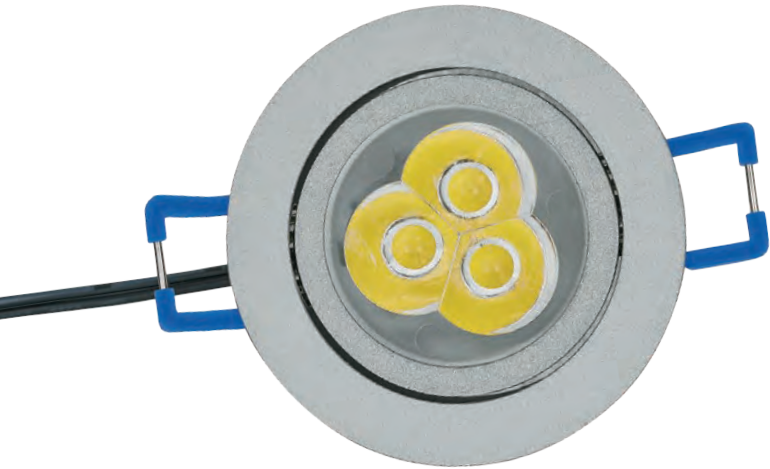

Features:

Compact 1-1/8" (29 mm) depth

Focused 30° beam spread with 12° of swivel

Extremely efficient at approximately 100 lumens per watt

All metal construction

Recess mount

Typical Applications:

Kiosks

Displays or store fixtures

Murphy beds

Elevators



Focused 30° beam spread



Available Finishes:



Black (BL)



Nickel (NI)

Dimensions:



Available in black or nickel

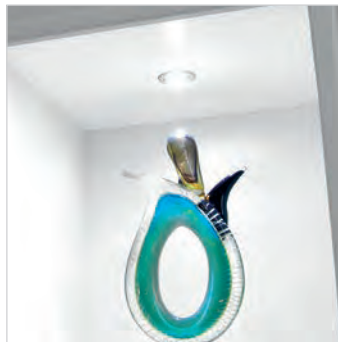

Spotlight your collectibles without the worry of heat or UV damage

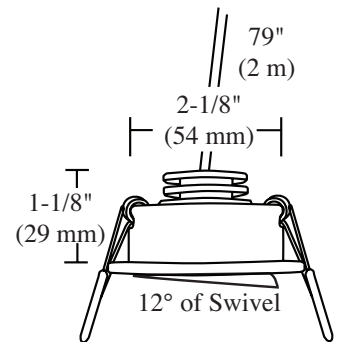
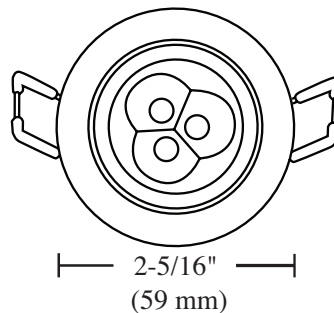

Typical Setup:

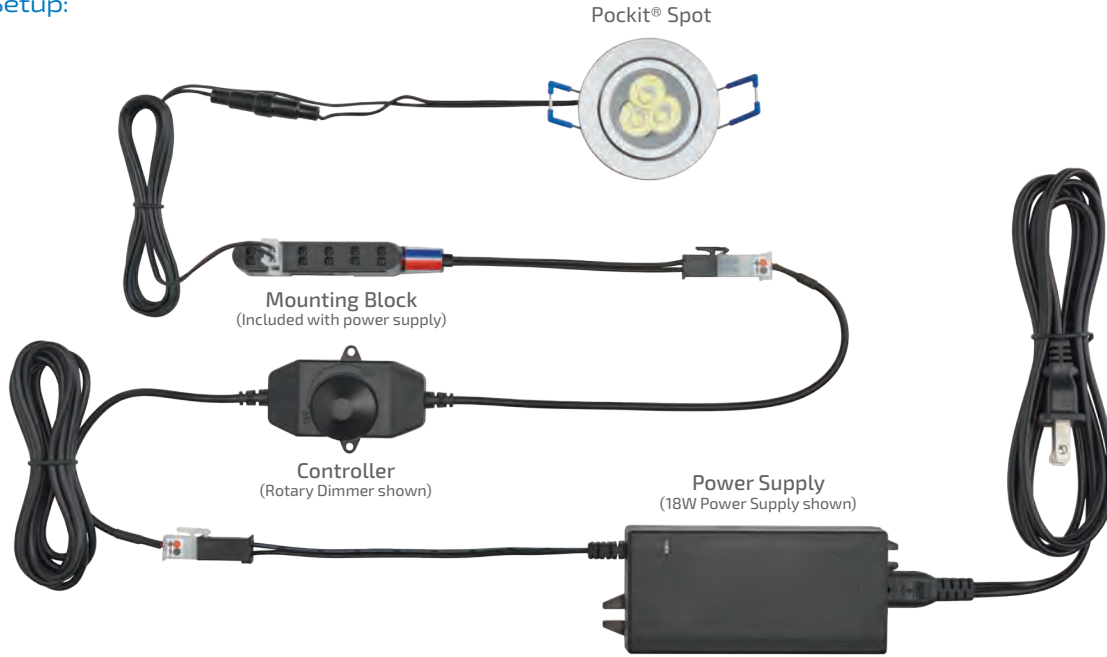

- Required
- Optional

Accessories:



● Required

Power Supplies
see power supply section



● Optional

Controllers
see controller section



● Optional

Starter Cord / Link Cords
see pg. 165 under starter/
extension cords

Specifications:

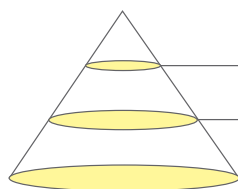
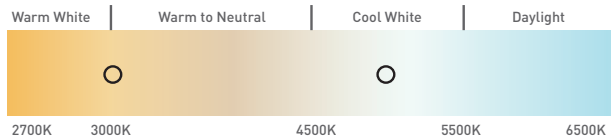
Wattage	Lumens	Efficacy (lm/W)	Input Voltage	Diode Life	Max Per 60W Power Supply	Mounting	Warranty	Beam Angle												
3W	298	99	12VDC	50,000 Hours	20 Fixtures	Recess	5 Year													
Photometric Data					Color Temperature															
 <table border="1" style="margin-left: auto; margin-right: auto;"> <thead> <tr> <th>Height</th> <th>Light Output</th> <th>Beam Area</th> </tr> </thead> <tbody> <tr> <td>1ft (.3 m)</td> <td>1,134Fc (12217.0lx)</td> <td>4ft L x .4ft W (.12 m L x .12 m W)</td> </tr> <tr> <td>3ft (.9 m)</td> <td>126Fc (1356.3lx)</td> <td>1.3ft L x 1.3ft W (.4 m L x .4 m W)</td> </tr> <tr> <td>6ft (1.8 m)</td> <td>31.5Fc (339.1lx)</td> <td>2.6ft L x 2.6ft W (.79 m L x .79 m W)</td> </tr> </tbody> </table> <p style="text-align: center; font-size: small;">L-LED-3DSP-C Tested</p>					Height	Light Output	Beam Area	1ft (.3 m)	1,134Fc (12217.0lx)	4ft L x .4ft W (.12 m L x .12 m W)	3ft (.9 m)	126Fc (1356.3lx)	1.3ft L x 1.3ft W (.4 m L x .4 m W)	6ft (1.8 m)	31.5Fc (339.1lx)	2.6ft L x 2.6ft W (.79 m L x .79 m W)	 <p style="text-align: center; font-size: small;"> Warm White Warm to Neutral Cool White Daylight 2700K 3000K 4500K 5500K 6500K ▲ Warm (3000K) ▲ Cool (5000K) </p>			
Height	Light Output	Beam Area																		
1ft (.3 m)	1,134Fc (12217.0lx)	4ft L x .4ft W (.12 m L x .12 m W)																		
3ft (.9 m)	126Fc (1356.3lx)	1.3ft L x 1.3ft W (.4 m L x .4 m W)																		
6ft (1.8 m)	31.5Fc (339.1lx)	2.6ft L x 2.6ft W (.79 m L x .79 m W)																		

See page 43 for part numbers and descriptions

Pockit[®] Adapt

12VDC



5W	250 Lumens	
<p>As the name suggests, this Pockit[®] is adaptable to specific applications using one of three included lenses. Whether your application calls for a narrow or wide angle spot, only a simple change of the lens is needed. The 5/8" (16 mm) depth makes this one of the lowest profile spotlights in the industry while generating a staggering 250 lumen output.</p>		

Features:

3 beam-angle changing lenses included: 25°, 45°, 60°

High output (250 lumens)

Aluminum die cast construction

Recess or surface mount – minimal 5/8" (16 mm) depth

Typical Applications:

Kiosks and displays

Flyovers

Cabinets and soffits

Murphy beds

Elevators



3 beam-angle changing lenses included



Available Finishes:

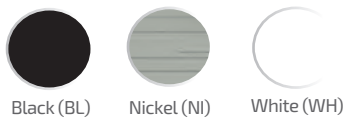

Dimensions:

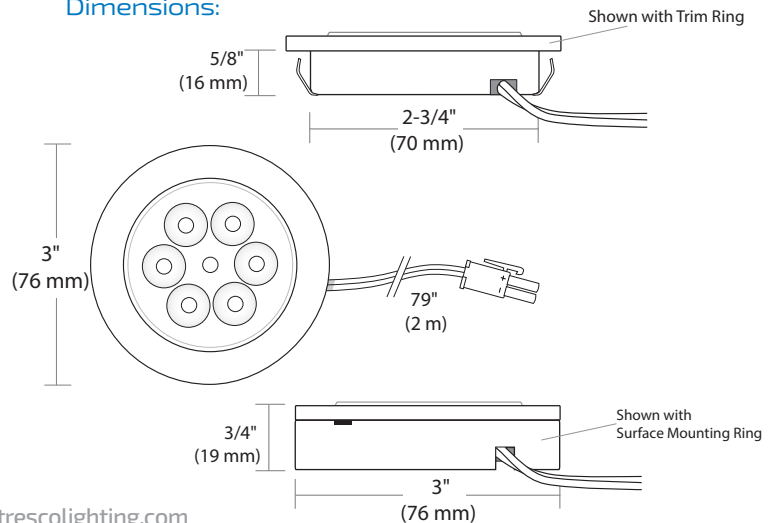

Recess or surface mount

Typical Setup:

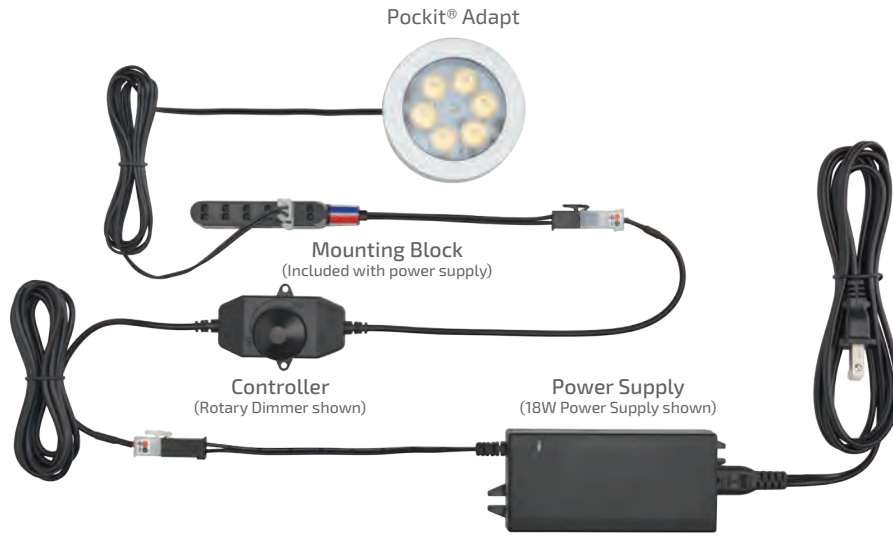

- Required
- Optional

Accessories:

Power Supplies
see power supply section

Pockit® Adapt Trim Kit
L-ADJTKIT-BL-1
L-ADJTKIT-NI-1
L-ADJTKIT-WH-1

Controllers
see controller section

Starter Cord / Link Cords
see pg. 165 under starter/
extension cords

Specifications:

Wattage	Lumens	Efficacy (lm/W)	Input Voltage	Diode Life	Max Per 60W Power Supply	Mounting	Warranty	Beam Angle
5W	250	50	12VDC	50,000 Hours	12 Fixtures	Recess/ Surface	5 Year	

Photometric Data

Height	Light Output (60° Lens)	Light Output (45° Lens)	Light Output (25° Lens)	Beam Area (60° Lens)	Beam Area (45° Lens)	Beam Area (25° Lens)
1ft (.3 m)	201.20Fc (2165.70lx)	456.80Fc (4916.95lx)	854.00Fc (9192.38lx)	1.1ft L x 1.1ft W (.34 m L x .34 m W)	.7ft L x .7ft W (.21 m L x .21 m W)	.5ft L x .5ft W (.15 m L x .15 m W)
3ft (.9 m)	22.36Fc (240.68lx)	50.76Fc (546.38lx)	94.89Fc (1021.39lx)	3.4ft L x 3.3ft W (1 m L x 1 m W)	2ft L x 2ft W (.61 m L x .61 m W)	1.4ft L x 1.4ft W (.43 m L x .43 m W)
6ft (1.8 m)	5.59Fc (60.17lx)	12.69Fc (136.59lx)	23.72Fc (255.32lx)	6.8ft L x 6.7ft W (2.1 m L x 2 m W)	4ft L x 4ft W (1.22 m L x 1.22 m W)	2.8ft L x 2.8ft W (.85 m L x .85 m W)

L-POC-5ADJ-C Tested

Color Temperature

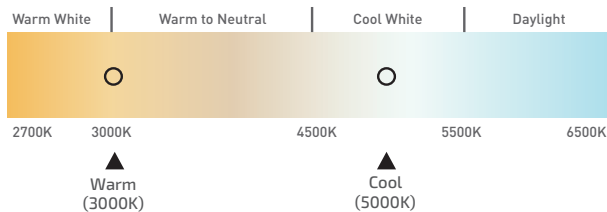

See page 44 for part numbers and descriptions

Economy Series

12VDC

3W EquiLine Puck

3W

218 Lumens

100°

With recessed or surface mount ability, EquiLine LED Pucks are perfect for use in a wide range of applications. Designed for the economically conscious, they feature a slim profile and a 79" (2 m) starter cord attached with an unattached AMP® connector for easy wire routing.



Features:

1/2" (13 mm) recessed depth

100° beam spread

Luniform output – no "dots"

Metal heatsink for cool operation

Recess or surface mount

Typical Applications:

Furniture

Desk

Headboards

Cabinets and light boxes

Closets (UL listed for use within closet storage spaces)



Slim 1/2" (13 mm) recess profile



Available Finishes:



Black (BL)



Nickel (NI)

Dimensions:

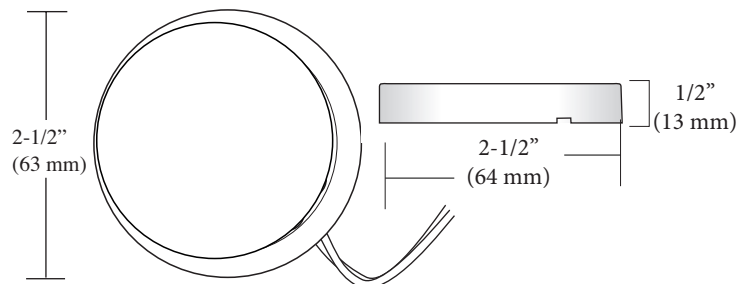
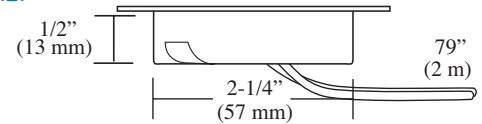

Available in Black or Nickel



Surface mount ring sold separately

Typical Setup:



- Required
- Optional

Accessories:



Power Supplies
see power supply section

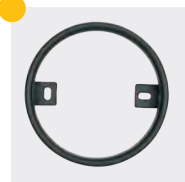

EquiLine Puck Surface Ring
L-SMR-2LED-BL-1
L-SMR-2LED-NI-1

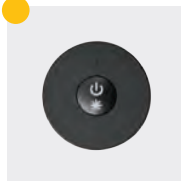

Controllers
see controller section

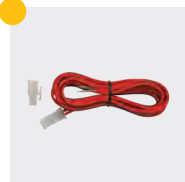

Starter Cord / Link Cords
see pg. 165 under starter/
extension cords

Specifications:

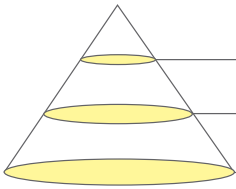
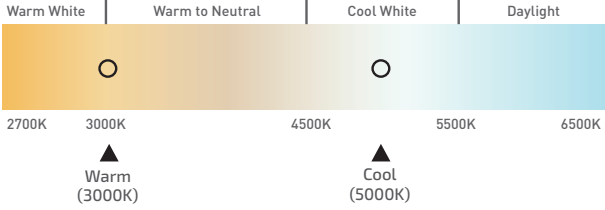
Wattage	Lumens	Efficacy (lm/W)	Input Voltage	Diode Life	Max Per 60W Power Supply	Mounting	Warranty	Beam Angle												
3W	218	73	12VDC	25,000 Hours	20 Fixtures	Recess/ Surface	2 Year													
Photometric Data					Color Temperature															
 <table border="1"> <thead> <tr> <th>Height</th> <th>Light Output</th> <th>Beam Area</th> </tr> </thead> <tbody> <tr> <td>1ft (.3 m)</td> <td>89.00Fc (958lx)</td> <td>2ft diameter (.6 m diameter)</td> </tr> <tr> <td>3ft (.9 m)</td> <td>9.89Fc (106.5lx)</td> <td>7ft diameter (2.1 m diameter)</td> </tr> <tr> <td>6ft (1.8 m)</td> <td>2.47Fc (26.6lx)</td> <td>14ft diameter (4.3 m diameter)</td> </tr> </tbody> </table>		Height	Light Output	Beam Area	1ft (.3 m)	89.00Fc (958lx)	2ft diameter (.6 m diameter)	3ft (.9 m)	9.89Fc (106.5lx)	7ft diameter (2.1 m diameter)	6ft (1.8 m)	2.47Fc (26.6lx)	14ft diameter (4.3 m diameter)	 <p>2700K 3000K 4500K 5500K 6500K</p> <p>Warm (3000K) Cool (5000K)</p>						
Height	Light Output	Beam Area																		
1ft (.3 m)	89.00Fc (958lx)	2ft diameter (.6 m diameter)																		
3ft (.9 m)	9.89Fc (106.5lx)	7ft diameter (2.1 m diameter)																		
6ft (1.8 m)	2.47Fc (26.6lx)	14ft diameter (4.3 m diameter)																		
L-POC-3EQFR-C Tested																				

See page 44 for part numbers and descriptions

Pockit® 120-M

120V

4W

270 Lumens



The Pockit® 120-M is the next generation of our popular Pockit® 120 linkable series. Featuring a smaller size, each fixture has a built-in dimmable driver and the commercial grade, all-metal construction provides optimal heatsinking with more than double the light output of the original Pockit® 120-L. No external power supply needed, just plug in and start linking away!



Features:

High output (270 lumens)

Lunifrom output – no "dots"

Dimmable to 50% by standard LED wall dimmers

No power supply required

Die cast construction

Typical Applications:

Displays

Task lighting/flood lighting

Interior cabinets/shelving

Under cabinets



Linkable up to 45 fixtures



True plug-and-play: no transformer or power supply required



Recess or surface mount (ring included)



Available Finishes:



Black (BL)



Nickel (NI)



White (WH)

Dimensions:

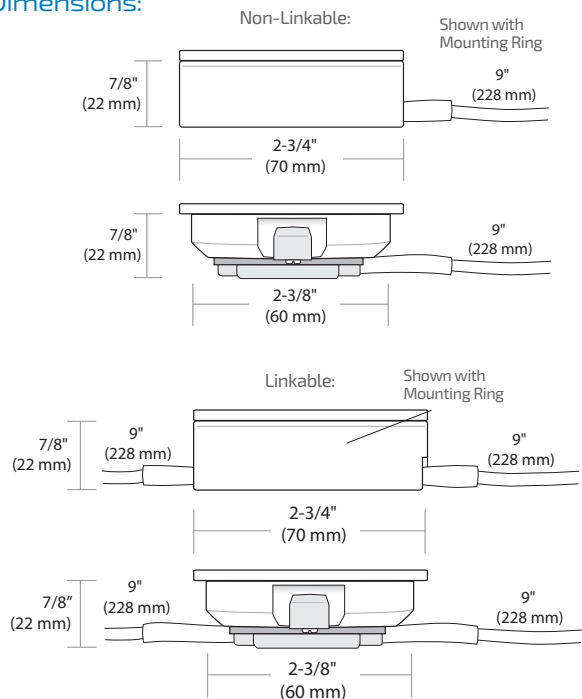

Typical Setup:

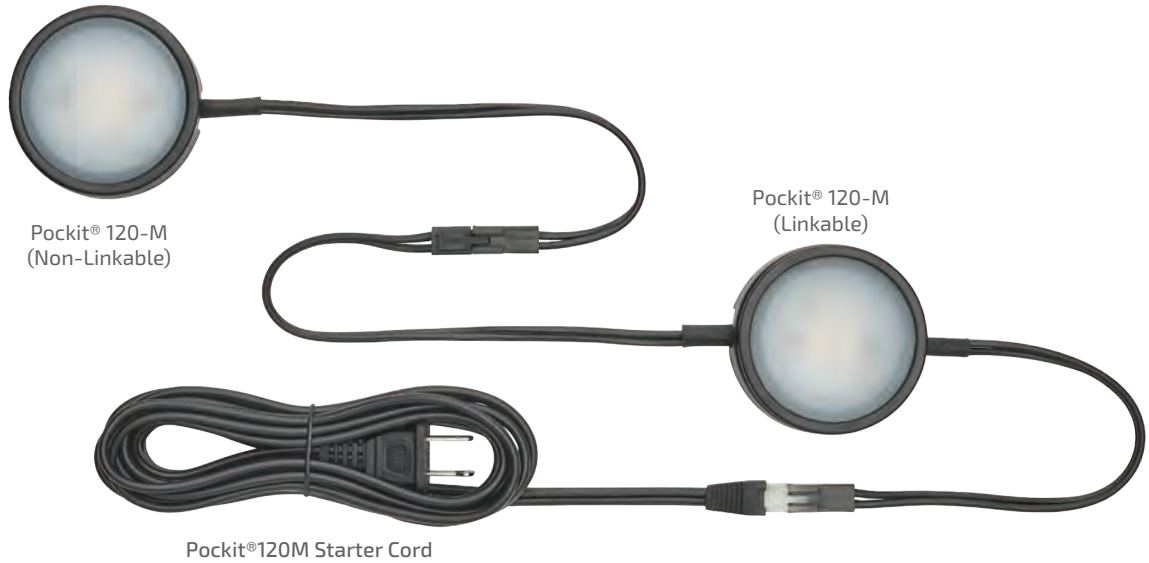

- Required
- Optional

Accessories:



Pockit® 120-M Starter Cord
L-MPOC-PKT8-BL-1
L-MPOC-PKT8-WH-1



Link Cord/Extension
L-FPOC-LINKA-25-BL-1
L-FPOC-LINKA-25-WH-1
L-FPOC-LINKA-60-BL-1
L-FPOC-LINKA-60-WH-1
L-FPOC-LINKA-120-BL-1
L-FPOC-LINKA-120-WH-1
L-FPOC-LINKA-180-BL-1
L-FPOC-LINKA-180-WH-1

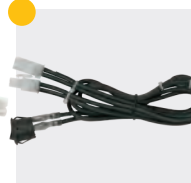

Round Switch - 120V
L-RDSW-1M-120-BL-1
L-RDSW-1M-120-WH-1
L-RDSW-2M-120-BL-1
L-RDSW-2M-120-WH-1



Touch On/Off Switch
L-TS2-72-1



Hardwire Boxes
L-HWB-BL-T5-1
L-HWB-WH-T5-1
L-HWB-BL-T5-S-1
L-HWB-WH-T5-S-1



Pockit® 120-L/M Adaptor for Hardwire Box
L-FPOC-HWB-ADP-WH-1
L-FPOC-HWB-ADP-BL-1

Specifications:

Dimmable up to 50%

Wattage	Lumens	Efficacy (lm/W)	Input Voltage	Diode Life	Max Continuous Run	Mounting	Warranty	Beam Angle												
4W	270	67.5	120V	30,000 Hours	45 Fixtures	Recess/ Surface	3 Year													
Photometric Data					Color Temperature															
<table border="1"> <thead> <tr> <th>Height</th> <th>Light Output</th> <th>Beam Area</th> </tr> </thead> <tbody> <tr> <td>1ft (.3m)</td> <td>110.5Fc (1189.4lx)</td> <td>2.3ft L x 2.3ft W (.7m L x .7m W)</td> </tr> <tr> <td>3ft (.9m)</td> <td>12.28Fc (132.2lx)</td> <td>6.9ft L x 6.9ft W (2.1m L x 2.1m W)</td> </tr> <tr> <td>6ft (1.8m)</td> <td>3.07Fc (33.0lx)</td> <td>13.9ft L x 13.8ft W (4.2m L x 4.2m W)</td> </tr> </tbody> </table> <p>L-MPOC-4W-120NL-C Tested</p>					Height	Light Output	Beam Area	1ft (.3m)	110.5Fc (1189.4lx)	2.3ft L x 2.3ft W (.7m L x .7m W)	3ft (.9m)	12.28Fc (132.2lx)	6.9ft L x 6.9ft W (2.1m L x 2.1m W)	6ft (1.8m)	3.07Fc (33.0lx)	13.9ft L x 13.8ft W (4.2m L x 4.2m W)	<p>Warm White Warm to Neutral Cool White Daylight</p> <p>2700K 3000K 4500K 5500K 6500K</p> <p>▲ Warm (3000K) ▲ Cool (5000K)</p>			
Height	Light Output	Beam Area																		
1ft (.3m)	110.5Fc (1189.4lx)	2.3ft L x 2.3ft W (.7m L x .7m W)																		
3ft (.9m)	12.28Fc (132.2lx)	6.9ft L x 6.9ft W (2.1m L x 2.1m W)																		
6ft (1.8m)	3.07Fc (33.0lx)	13.9ft L x 13.8ft W (4.2m L x 4.2m W)																		

See page 45 for part numbers and descriptions

● 12VDC Pockit® Plus 1.5W Series

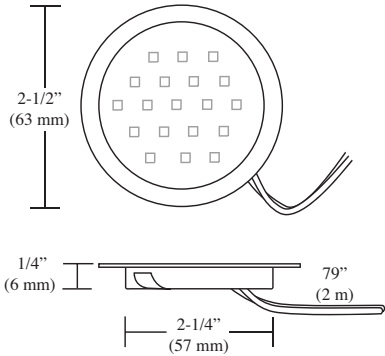

Surface Mount Ring is included with each light.

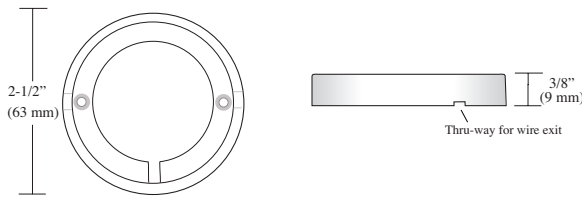

Part #	Description
L-POC-1LEDSFR-CBL-1	1.5W 5000K Black LED Metal Pockit® Light
L-POC-1LEDSFR-CNI-1	1.5W 5000K Nickel LED Metal Pockit® Light
L-POC-1LEDSFR-CORB-1	1.5W 5000K Oil-Rubbed Bronze Pockit® Light
L-POC-1LEDSFR-CWH-1	1.5W 5000K White LED Metal Pockit® Light
L-POC-1LEDSFR-WBL-1	1.5W 3000K Black LED Metal Pockit® Light
L-POC-1LEDSFR-WNI-1	1.5W 3000K Nickel LED Metal Pockit® Light
L-POC-1LEDSFR-WORB-1	1.5W 3000K Oil-Rubbed Bronze Pockit® Light
L-POC-1LEDSFR-WWH-1	1.5W 3000K White LED Metal Pockit® Light

2-1/4" (57 mm) hole required for recessed mounting.
Pockit® Plus Includes 79" (2 m) Starter Cord, Surface Mount Ring, and AMP® Connector.

● 12VDC 3W Power Pockit® Series

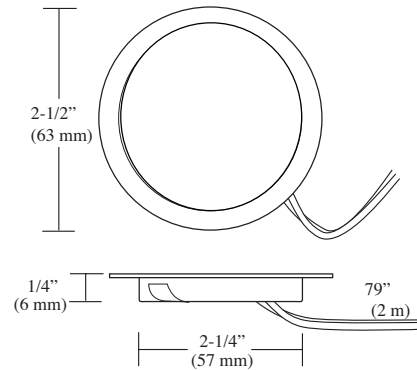

Surface Mount Ring is included with each light.

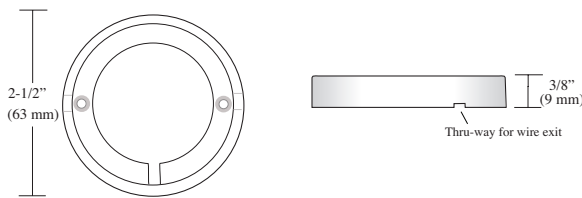

Part #	Description
L-POC-3LEDSFR-CAB-1	3W 5000K Antique Brass LED Pockit® Light
L-POC-3LEDSFR-CBL-1	3W 5000K Black LED Pockit® Light
L-POC-3LEDSFR-CCH-1	3W 5000K Chrome LED Pockit® Light
L-POC-3LEDSFR-CNI-1	3W 5000K Nickel LED Pockit® Light
L-POC-3LEDSFR-CWH-1	3W 5000K White LED Pockit® Light
L-POC-3LEDSFR-NNI-1	3W 3500K Nickel LED Pockit® Light
L-POC-3LEDSFR-NBL-1	3W 3500K Black LED Pockit® Light
L-POC-3LEDSFR-WAB-1	3W 3000K Antique Brass LED Pockit® Light
L-POC-3LEDSFR-WBL-1	3W 3000K Black LED Pockit® Light
L-POC-3LEDSFR-WCH-1	3W 3000K Chrome LED Pockit® Light
L-POC-3LEDSFR-WNI-1	3W 3000K Nickel LED Pockit® Light
L-POC-3LEDSFR-WORB-1	3W 3000K Oil-Rubbed Bronze LED Pockit® Light
L-POC-3LEDSFR-WWH-1	3W 3000K White LED Pockit® Light

2-1/4" (57 mm) hole required for recessed mounting.
Power Pockit® includes Surface Mount Ring, AMP® Connector, and 79" (2 m) of input lead.



COMPONENTS: POWER SUPPLIES, CONTROLLERS AND MORE SEE PAGE 141.

● 12VDC 5W Power Pockit®

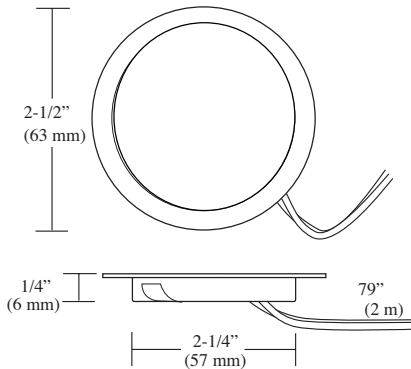

Surface Mount Ring is included with each light.

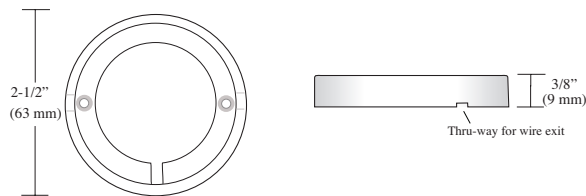

Part #	Description
L-POC-5LEDSCL-CBL-1	5W 5000K Black LED Pockit® Light
L-POC-5LEDSCL-CNI-1	5W 5000K Nickel LED Pockit® Light
L-POC-5LEDSCL-CWH-1	5W 5000K White LED Pockit® Light
L-POC-5LEDSCL-WBL-1	5W 3000K Black LED Pockit® Light
L-POC-5LEDSCL-WNI-1	5W 3000K Nickel LED Pockit® Light
L-POC-5LEDSCL-WORB-1	5W 3000K Oil-Rubbed Bronze LED Pockit® Light
L-POC-5LEDSCL-WWH-1	5W 3000K White LED Pockit® Light

2-1/4" (57 mm) hole required for recessed mounting.
Power Pockit® includes Surface Mount Ring, AMP® Connector, and 79" (2 m) input lead.

● 12VDC Pockit® Point LED Series

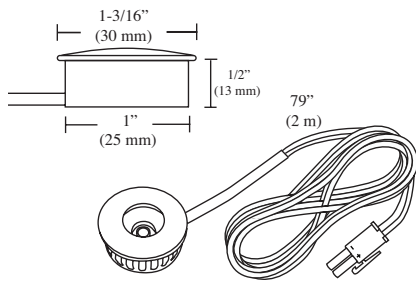

Part #	Description
L-LED-1EB-CBL-1	1W 12VDC Pockit® Point, 5000K, Black
L-LED-1EB-CNI-1	1W 12VDC Pockit® Point, 5000K, Nickel
L-LED-1EB-CWH-1	1W 12VDC Pockit® Point, 5000K, White
L-LED-1EB-WBL-1	1W 12VDC Pockit® Point, 3000K, Black
L-LED-1EB-WNI-1	1W 12VDC Pockit® Point, 3000K, Nickel
L-LED-1EB-WWH-1	1W 12VDC Pockit® Point, 3000K, White

1" (25 mm) hole required for recessed mounting.
Collar Spring, 79" (2 m) Starter Cord, and AMP® Connector are included with each light.

● 12VDC Pockit® Spot

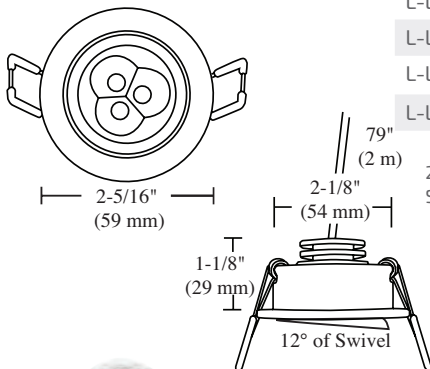

Part #	Description
L-LED-3DSP-CBL-1	3W 5000K Black Recess Pockit® Swivel Spot
L-LED-3DSP-CNI-1	3W 5000K Satin Nickel Recess Pockit® Swivel Spot
L-LED-3DSP-WBL-1	3W 3000K Black Recess Pockit® Swivel Spot
L-LED-3DSP-WNI-1	3W 3000K Satin Nickel Recess Pockit® Swivel Spot

2-1/8" (54 mm) hole required for recessed mounting.
Starter Cord 79" (2 m), and AMP® Connector are included with each light.



COMPONENTS: POWER SUPPLIES, CONTROLLERS AND MORE SEE PAGE 141.

- Required
- Optional

● 12VDC Pockit® Adapt

Part

Description

L-POC-5ADJ-C-1	12VDC 5W Pockit® Adapt, 5000K
L-POC-5ADJ-W-1	12VDC 5W Pockit® Adapt, 3000K

2-5/8" (67 mm) hole required for recessed mounting.
79" (2 m) Starter Cord, and AMP® Connector are included with each light.
Trim kit purchased separately.

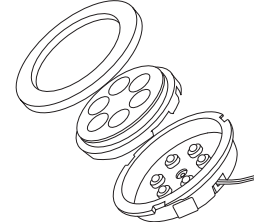
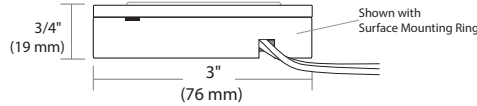
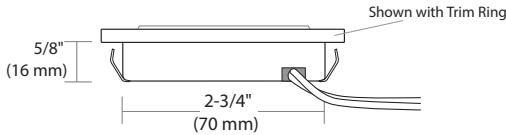
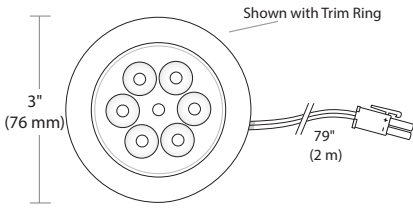

● 12VDC Pockit® Adapt Trim Kit

Part

Description

L-ADJTKIT-BL-1	Pockit® Adapt Trim Kit, Black
L-ADJTKIT-NI-1	Pockit® Adapt Trim Kit, Nickel
L-ADJTKIT-WH-1	Pockit® Adapt Trim Kit, White

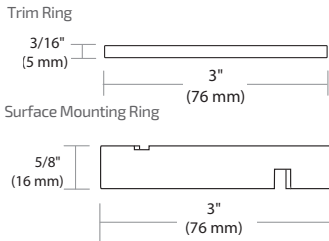

● 12VDC EquiLine Puck Light

Part

Description

L-POC-3EQFR-CBL-1	3W EquiLine Puck 5000K - Black
L-POC-3EQFR-CNI-1	3W EquiLine Puck 5000K - Nickel
L-POC-3EQFR-WBL-1	3W EquiLine Puck 3000K - Black
L-POC-3EQFR-WNI-1	3W EquiLine Puck 3000K - Nickel

2-1/4" (57 mm) hole required for recessed mounting.
EquiLine includes starter cord 79" (2 m) and AMP® Connector with each light.
Surface mount ring sold separately.

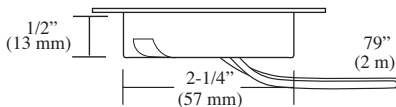
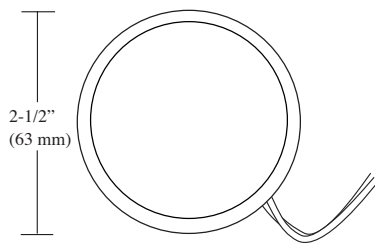

● 12VDC EquiLine Puck Surface Ring

Part

Description

L-SMR-2LED-BL-1	EquiLine Puck Surface Ring Black
L-SMR-2LED-NI-1	EquiLine Puck Surface Ring Nickel

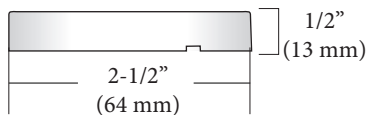

COMPONENTS: POWER SUPPLIES, CONTROLLERS AND MORE SEE PAGE 141.

● 12VDC Power Supplies



For details see
Power Supplies
on Page 142.

Part #	Description
L-DC-ELT18-CON-1	18W 12VDC Power Supply w/6 Snap Mounting Block*
L-DC-SLELT30-1	30W 12VDC Power Supply w/6 Snap Mounting Block*
L-DC-SLELT60-1	60W 12VDC Power Supply w/6 Snap Mounting Block*
L-DC-ELT6WP-CON-1	6W 12VDC Wall Mount Power Supply w/3 Snap Block*
L-DC-ELT15WP-CON-1	15W 12VDC Wall Mount Power Supply w/6 Snap Block*
L-DC-EQ30-1	30W 12VDC Equiline Power Supply w/6 Snap Block*
L-DC-EQ60-1	60W 12VDC Equiline Power Supply w/6 Snap Block*
L-DCE30D-CON-1	30W 12VDC Hardwire Dimmable LED Power Supply†
L-DCE60D-CON-1	60W 12VDC Hardwire Dimmable LED Power Supply†
L-12DCH60X1-1	60W 12VDC Commercial/Industrial Metal Hardwire Dimmable Power Supply‡
L-12DCH60X3-1	180W 12VDC Commercial/Industrial Metal Hardwire Dimmable Power Supply‡

* Dimmable on trailing edge (12VDC side). Mounting block and power cord are included.
† Dimmable by LED line voltage (120V) wall dimmers. Mounting block included.
‡ Dimmable by LED line voltage (120V) wall dimmers. Mounting block not included
All hardwire power supplies require an electrician for install.

● 120V Pockit® 120M-Non-Linkable

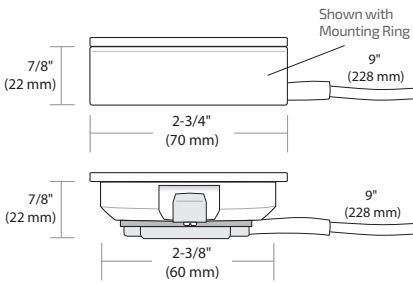

Part #	Description
L-MPOC-4W-120NL-CBL-1	120V Pockit® 120-M Non-Linkable, Cool, Black
L-MPOC-4W-120NL-CNI-1	120V Pockit® 120-M Non-Linkable, Cool, Nickel
L-MPOC-4W-120NL-CWH-1	120V Pockit® 120-M Non-Linkable, Cool, White
L-MPOC-4W-120NL-WBL-1	120V Pockit® 120-M Non-Linkable, Warm, Black
L-MPOC-4W-120NL-WNI-1	120V Pockit® 120-M Non-Linkable, Warm, Nickel
L-MPOC-4W-120NL-WWH-1	120V Pockit® 120-M Non-Linkable, Warm, White

2-3/8" (60 mm) hole required for recessing.
Surface mount ring included with each light.
Dimmable to 50% by standard LED wall dimmers.

● 120V Pockit® 120-M-Linkable

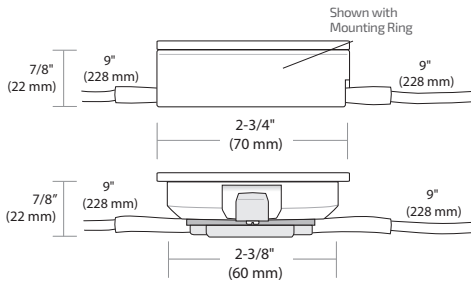

Part #	Description
L-MPOC-4W-120L-CBL-1	120V Pockit® 120-M Linkable, Cool, Black
L-MPOC-4W-120L-CNI-1	120V Pockit® 120-M Linkable, Cool, Nickel
L-MPOC-4W-120L-CWH-1	120V Pockit® 120-M Linkable, Cool, White
L-MPOC-4W-120L-WBL-1	120V Pockit® 120-M Linkable, Warm, Black
L-MPOC-4W-120L-WNI-1	120V Pockit® 120-M Linkable, Warm, Nickel
L-MPOC-4W-120L-WWH-1	120V Pockit® 120-M Linkable, Warm, White

2-3/8" (60 mm) hole required for recessing.
Surface mount ring included with each light.
Dimmable to 50% by standard LED wall dimmers.

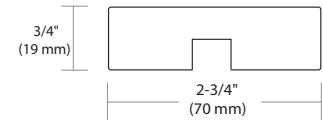

COMPONENTS: POWER SUPPLIES, CONTROLLERS AND MORE SEE PAGE 141.

- Required
- Optional

● 120V Pockit® 120-M Starter Cord

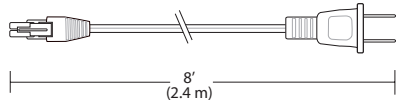

Part #	Description
L-MPOC-PKT8-BL-1	120V Pockit® 120-M, 8 ft. (2.4 m) Starter Cord, Black
L-MPOC-PKT8-WH-1	120V Pockit® 120-M, 8 ft. (2.4 m) Starter Cord, White

● 120V Link Cord/Extension

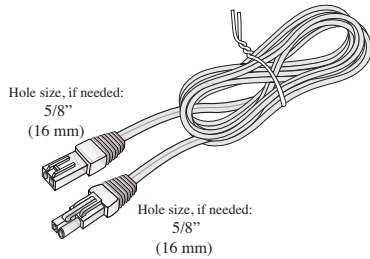

Part #	Description
L-FPOC-LINKA-25-BL-1	10" (25 cm) Black Pockit® 120-L/M Linking Cord
L-FPOC-LINKA-25-WH-1	10" (25 cm) White Pockit® 120-L/M Linking Cord
L-FPOC-LINKA-60-BL-1	24" (60 cm) Black Pockit® 120-L/M Linking Cord
L-FPOC-LINKA-60-WH-1	24" (60 cm) White Pockit® 120-L/M Linking Cord
L-FPOC-LINKA-120-BL-1	48" (120 cm) Black Pockit® 120-L/M Linking Cord
L-FPOC-LINKA-120-WH-1	48" (120 cm) White Pockit® 120-L/M Linking Cord
L-FPOC-LINKA-180-BL-1	72" (180 cm) Black Pockit® 120-L/M Linking Cord
L-FPOC-LINKA-180-WH-1	72" (180 cm) White Pockit® 120-L/M Linking Cord

● 120V Round Switch

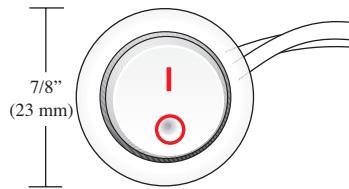

Part #	Description
L-RDSW-1M-120-BL-1	120V Black Round Rocker Switch w/ 39" (1 m) Lead
L-RDSW-1M-120-WH-1	120V White Round Rocker Switch w/ 39" (1 m) Lead
L-RDSW-2M-120-BL-1	120V Black Round Rocker Switch w/ 79" (2 m) Lead
L-RDSW-2M-120-WH-1	120V White Round Rocker Switch w/ 79" (2 m) Lead

3/4" (19 mm) hole required.

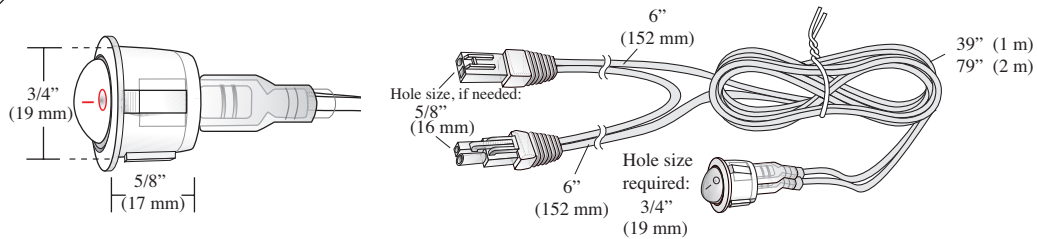

● 120V Touch On/Off Switch

Part #	Description
L-TS2-72-1	Touch On/Off w/Cord And Touch Pad. Black, 200W

On/off Switch touch pad attaches to surface with adhesive backing. Power supply plugs into on/off switch touch pad.

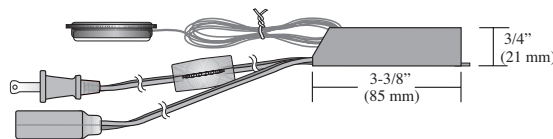
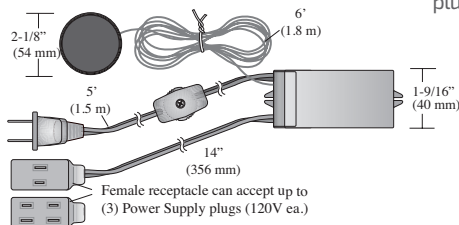

COMPONENTS: POWER SUPPLIES, CONTROLLERS AND MORE SEE PAGE 141.

- Required
- Optional

● 120V Hardwire Boxes

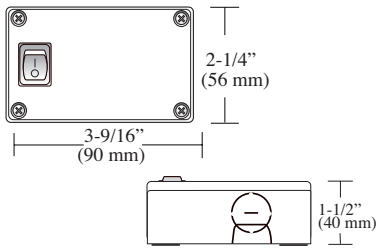

Part #	Description
L-HWB-BL-T5-1	T5 Black Hardwire Box, without Switch
L-HWB-WH-T5-1	T5 White Hardwire Box, without Switch
L-HWB-BL-T5-S-1	T5 Black Hardwire Box, with Switch
L-HWB-WH-T5-S-1	T5 White Hardwire Box, with Switch

Maximum (10) light fixtures per hardwire box.
Must use Pockit® 120L/M Adaptor.

● 120V Pockit® 120-L/M Adaptor for Hardwire Box

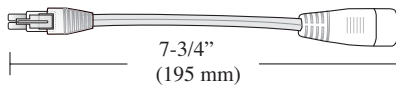

Part #	Description
L-FPOC-HWB-ADP-BL-1	Pockit® 120-M Adaptor for Hardwire Box, Black
L-FPOC-HWB-ADP-WH-1	Pockit® 120-M Adaptor for Hardwire Box, White

Required when using Hardwire Box.

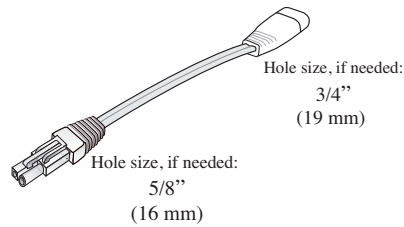

NOTE: Must use hardwire box when used with a wall dimmer. Do not dim a receptacle.

How to Connect Using Hardwire Box:

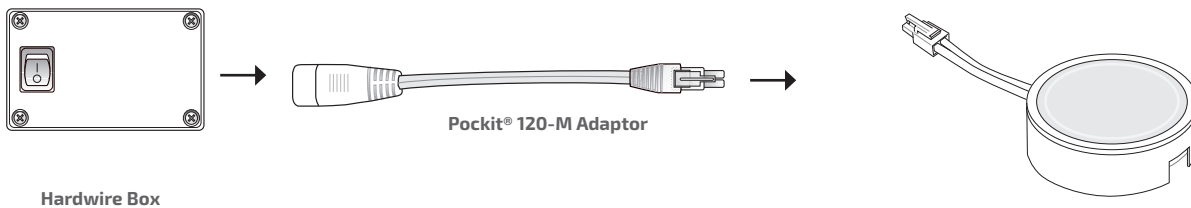

● 120V LED Wall Dimmers



Part #	Description
L-DVCL-153P-WH-1	Lutron Diva® C-L™ 150W Dimmer w/o Plate
L-CTCL-153P-WH-1	Lutron Skylark Contour C-L™ 150W Dimmer w/o Plate
L-DSL06-1LZ-1	Leviton Decora 300W LED Dimmer w/WH-IV-LA Kit



COMPONENTS: POWER SUPPLIES, CONTROLLERS AND MORE SEE PAGE 141.





12VDC
120V

LINEAR

NEW!

12VDC

FineLine 2.0

4.4W/ft.
(14.4W/m)

330 Lumens per ft.
(1082 per meter)



Pencil thin but still packing a big punch, FineLine is the unobtrusive way to provide stunning lighting to casework, displays, store fixtures and more. The low-profile design features a milk diffuser for even illumination, Luniform technology, and with optional manual or remote-control dimmers, creating the perfect atmosphere is effortless.

Features:

Miniature Profile – 5/16" (8 mm)

120° beam angle

*Luniform output – no "dots"

Available in (4) lengths – 8" (203 mm), 12" (305 mm), 22" (559 mm), or 34" (864 mm)

Linkable

79" (2 m) starter cord included

Surface mount

Typical Applications:

Shelving

Displays or store fixtures

Interior and under cabinets

Food service equipment

Closets (UL listed for use within closet storage spaces)

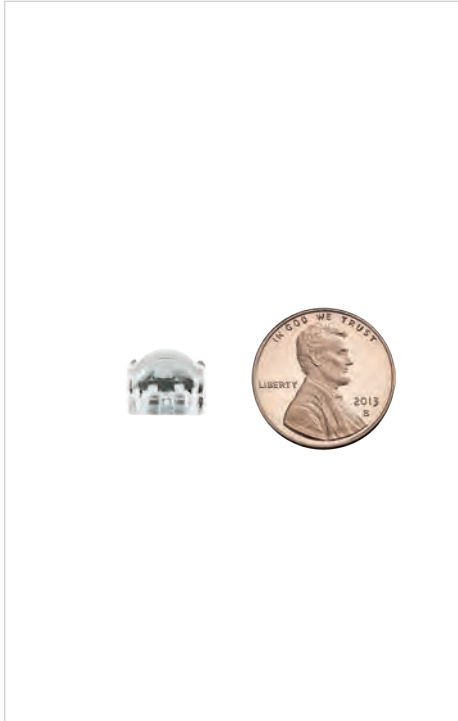

Extremely thin, 5/16" (8 mm) low-profile design

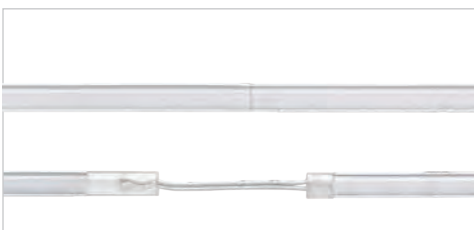

Linkable (seamless back-to-back or link cord) up to 12 ft. (3.66 m) continuous run

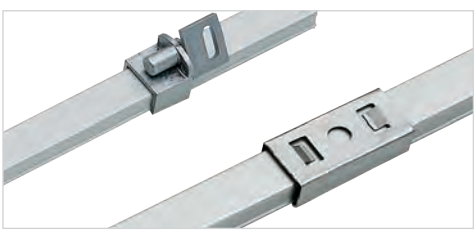

Straight and adjustable mounting U-clips included



Available Finishes:



Aluminum (AL)

*Fixture may require a slight angle using included swivel clips to eliminate diode reflection on some surfaces

Dimensions:

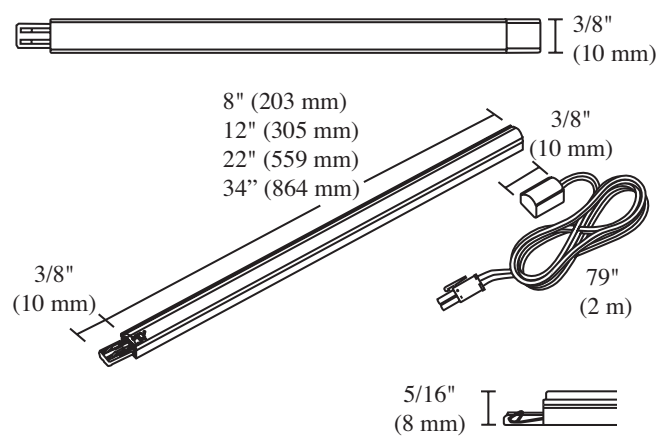

Typical Setup:

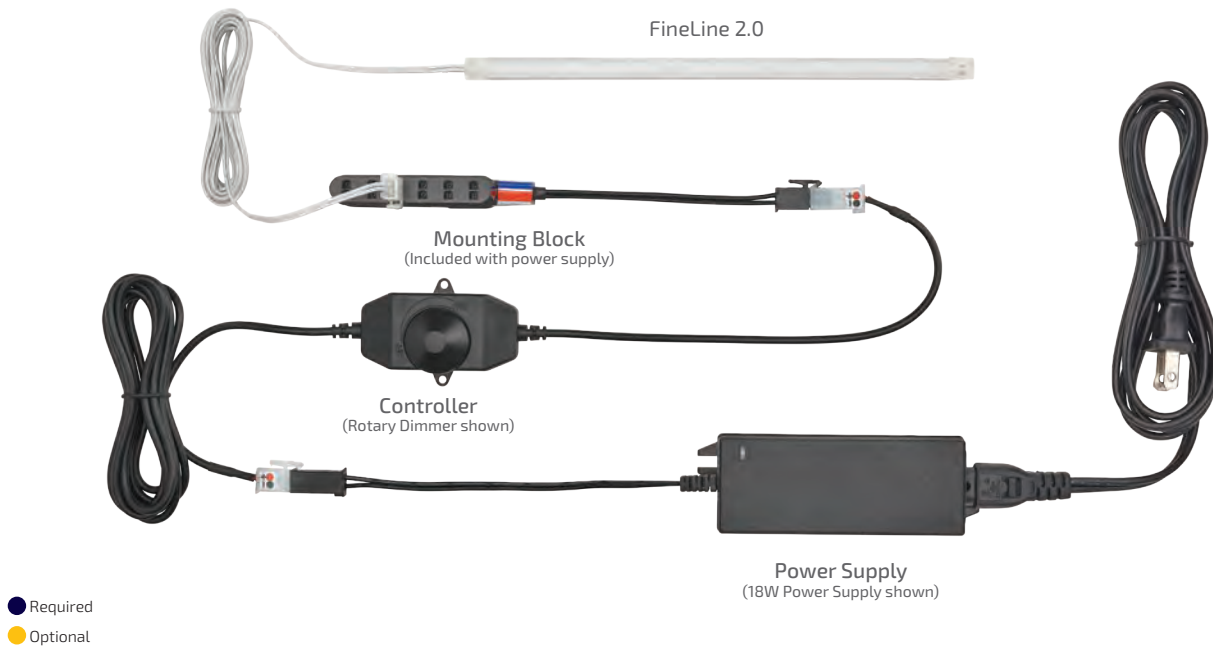

Accessories:



Power Supplies
see power supply section

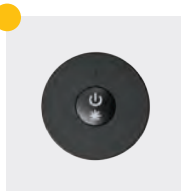

Controllers
see controller section



FineLine Link Cord
L-LED-STKLNK-5-1
L-LED-STKLNK-15-1
L-LED-STKLNK-25-1
L-LED-STKLNK-60-1
L-LED-STKLNK-120-1
L-LED-STKLNK-180-1

Specifications:

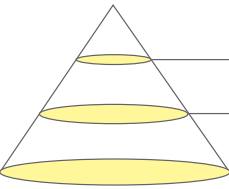
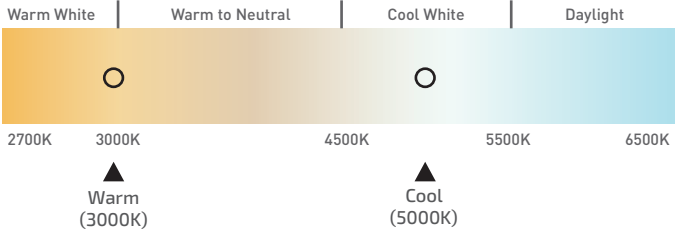
Wattage	Lumens	Efficacy (lm/W)	Input Voltage	Diode Life	Max Per 60W Power Supply	Max Continuous Run	Mounting	Warranty	Beam Angle												
4.4W/ft. (14.4W/m)	330 per ft. (1082 per m)	75	12VDC	50,000 Hours	13' (4 m)	12' (3.66 m)	Surface	5 Year													
Photometric Data					Color Temperature																
 <table border="1"> <thead> <tr> <th>Height</th> <th>Light Output</th> <th>Beam Area</th> </tr> </thead> <tbody> <tr> <td>1ft (.3 m)</td> <td>279Fc (3003.1lx)</td> <td>3.4ft L x 3.6ft W (1 m L x 1.1 m W)</td> </tr> <tr> <td>3ft (.9 m)</td> <td>31.0Fc (333.6lx)</td> <td>10.3ft L x 10.8ft W (3.1 m L x 3.3 m W)</td> </tr> <tr> <td>6ft (1.8 m)</td> <td>7.75Fc (83.4lx)</td> <td>20.5ft L x 21.6ft W (6.2 m L x 6.6 m W)</td> </tr> </tbody> </table> <p>L-STKH034-CNI-1 Tested</p>					Height	Light Output	Beam Area	1ft (.3 m)	279Fc (3003.1lx)	3.4ft L x 3.6ft W (1 m L x 1.1 m W)	3ft (.9 m)	31.0Fc (333.6lx)	10.3ft L x 10.8ft W (3.1 m L x 3.3 m W)	6ft (1.8 m)	7.75Fc (83.4lx)	20.5ft L x 21.6ft W (6.2 m L x 6.6 m W)	 <p>Warm White Warm to Neutral Cool White Daylight</p> <p>2700K 3000K 4500K 5500K 6500K</p> <p>▲ Warm (3000K) ▲ Cool (5000K)</p>				
Height	Light Output	Beam Area																			
1ft (.3 m)	279Fc (3003.1lx)	3.4ft L x 3.6ft W (1 m L x 1.1 m W)																			
3ft (.9 m)	31.0Fc (333.6lx)	10.3ft L x 10.8ft W (3.1 m L x 3.3 m W)																			
6ft (1.8 m)	7.75Fc (83.4lx)	20.5ft L x 21.6ft W (6.2 m L x 6.6 m W)																			

See page 64 for part numbers and descriptions

12VDC

SimpLED 2.0

5W/ft.
(16.4W/m)

470 Lumens
per ft.
(1541 per meter)



The SimpLED 2.0 sets the bar for light output and simplicity. With the patented push-in "H" connection system and inline control modules, you get the simplest and quickest installation possible. Use either straight or pivoting mounting clips, then snap the fixtures into place to let over 470 lumens per foot illuminate your project.

US PATENT NO: 8,545,045

Features:

Clean, low-profile aluminum finish – 3/8" (10 mm)

Uniform output – no "dots"

Available in (3) lengths – 8" (203 mm), 12" (305 mm) or 22" (559 mm)

(3) diffuser options included

Linkable

Optional series of in-line controllers available

Integrated magnets for mounting to metal

Surface mount

Typical Applications:

Showcases

Displays or store fixtures

Task lighting

Metal shelving

Office furniture

Under cabinet



Linkable (back-to-back or link cord) up to 10' (3 m) continuous run

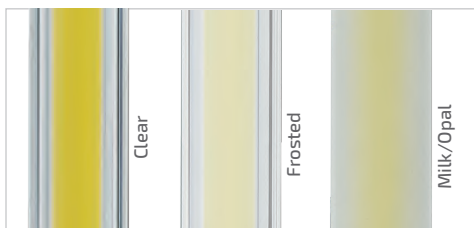

Three diffuser options packaged with each light



Straight and adjustable mounting U-clips and magnets included



Available Finishes:



Aluminum (AL)

Dimensions:

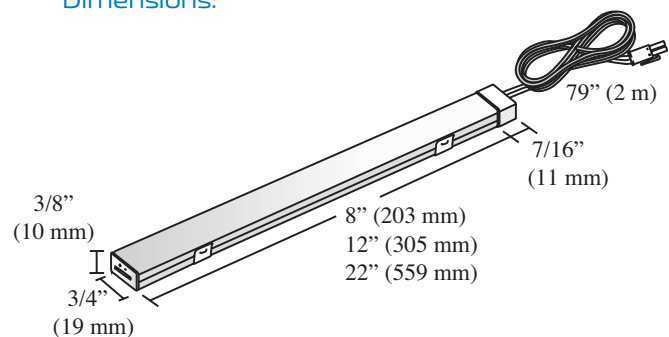

Typical Setup:

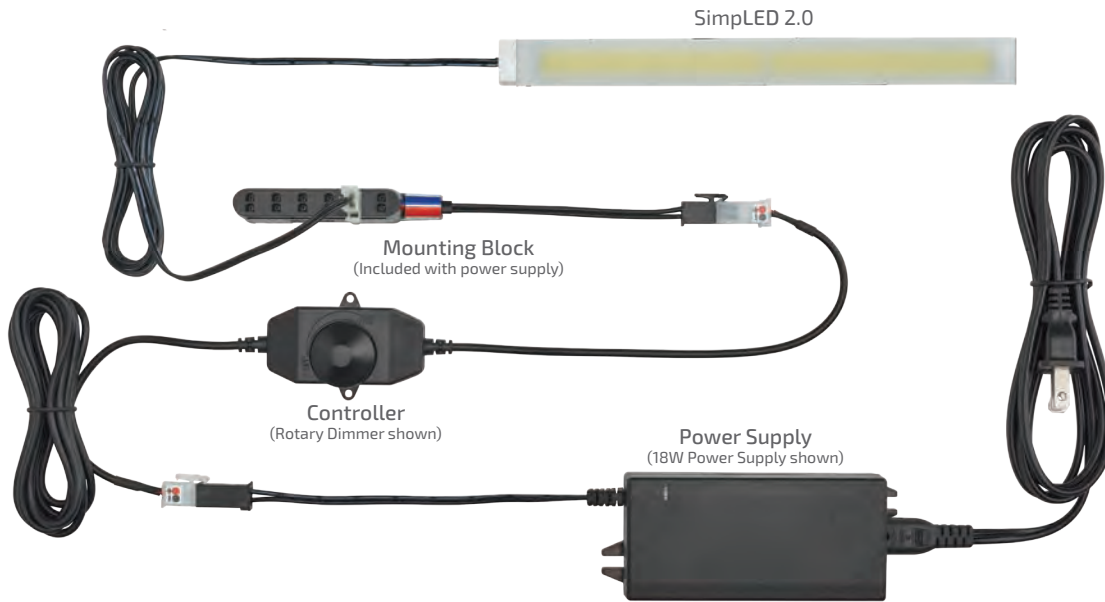

- Required
- Optional

Accessories:



Power Supplies
see power supply section

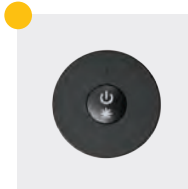

Controllers
see controller section

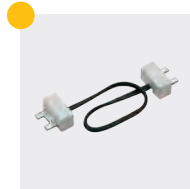

SimpLED Link Cord
L-LED-SMPLNK-5-1
L-LED-SMPLNK-15-1
L-LED-SMPLNK-25-1
L-LED-SMPLNK-60-1
L-LED-SMPLNK-120-1
L-LED-SMPLNK-180-1



Rectangle Inline Touch Dimmer (27 Watt Max)
L-LED-SMPTD4-1



Rectangle Inline Motion Sensor (27 Watt Max)
L-LED-SMPMOT-1

Specifications:

Wattage	Lumens	Efficacy (lm/W)	Input Voltage	Diode Life	Max Per 60W Power Supply	Max Continuous Run	Mounting	Warranty	Beam Angle								
5W/ft. (16.4W/m)	470 per ft. (1541 per m)	94	12VDC	50,000 Hours	12' (3.7 m)	10' (3 m)	Surface	5 Year									
Photometric Data					Color Temperature												
		<table border="1"> <thead> <tr> <th>Height</th> <th>Light Output</th> <th>Beam Area</th> </tr> </thead> <tbody> <tr> <td>1ft (.3 m)</td> <td>244.70Fc (2634lx)</td> <td>2.7ft L x 2.8ft W (.82 m L x .85 m W)</td> </tr> <tr> <td>3ft (.9 m)</td> <td>27.19Fc (292.7lx)</td> <td>8.2ft L x 8.3ft W (2.5 m L x 2.5 m W)</td> </tr> <tr> <td>6ft (1.8 m)</td> <td>6.80Fc (73.2lx)</td> <td>16.4ft L x 16.5ft W (5 m L x 5 m W)</td> </tr> </tbody> </table>	Height	Light Output	Beam Area	1ft (.3 m)	244.70Fc (2634lx)	2.7ft L x 2.8ft W (.82 m L x .85 m W)	3ft (.9 m)	27.19Fc (292.7lx)	8.2ft L x 8.3ft W (2.5 m L x 2.5 m W)	6ft (1.8 m)	6.80Fc (73.2lx)	16.4ft L x 16.5ft W (5 m L x 5 m W)			
Height	Light Output	Beam Area															
1ft (.3 m)	244.70Fc (2634lx)	2.7ft L x 2.8ft W (.82 m L x .85 m W)															
3ft (.9 m)	27.19Fc (292.7lx)	8.2ft L x 8.3ft W (2.5 m L x 2.5 m W)															
6ft (1.8 m)	6.80Fc (73.2lx)	16.4ft L x 16.5ft W (5 m L x 5 m W)															
L-SMPHO22-CNI-1 Tested					<p>Warm White Warm to Neutral Cool White Daylight</p> <p>2700K 3000K 4500K 5500K 6500K</p> <p>▲ Warm (3000K) ▲ Cool (5000K)</p>												

See page 65 for part numbers and descriptions

12VDC

Eurolinx

4W/ft.
(13.1W/m)

216 Lumens
per ft.
(708 per meter)



The Eurolinx's flat profile blends in with any application. Using specialized diffuser and reflector technology to achieve Luniform output, this European style light is a perfect choice for all contemporary and high-end commercial applications. Use the optional magnetic U-Clips for metal shelving or office furniture mounting. At 4W per foot and over 200 lumens, Eurolinx is a top pick for sleek high illumination.



Sleek, contemporary European design



Linkable (back-to-back or link cord) up to 10' (3 m) continuous run



Mounting clips included. Mounting clips with magnets sold separately.

Features:

Flat slim design – 5/16" (8 mm)

Two beam spreads based on orientation

Luniform output – no "dots"

Available in (5) lengths

Linkable

Surface mount

Typical Applications:

Cabinets or shelving

Task lighting

Showcases



Available Finishes:



Aluminum (AL)

Dimensions:

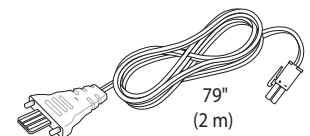
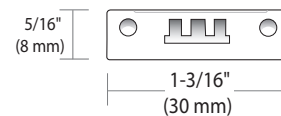
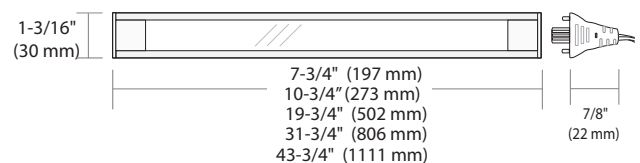

Typical Setup:

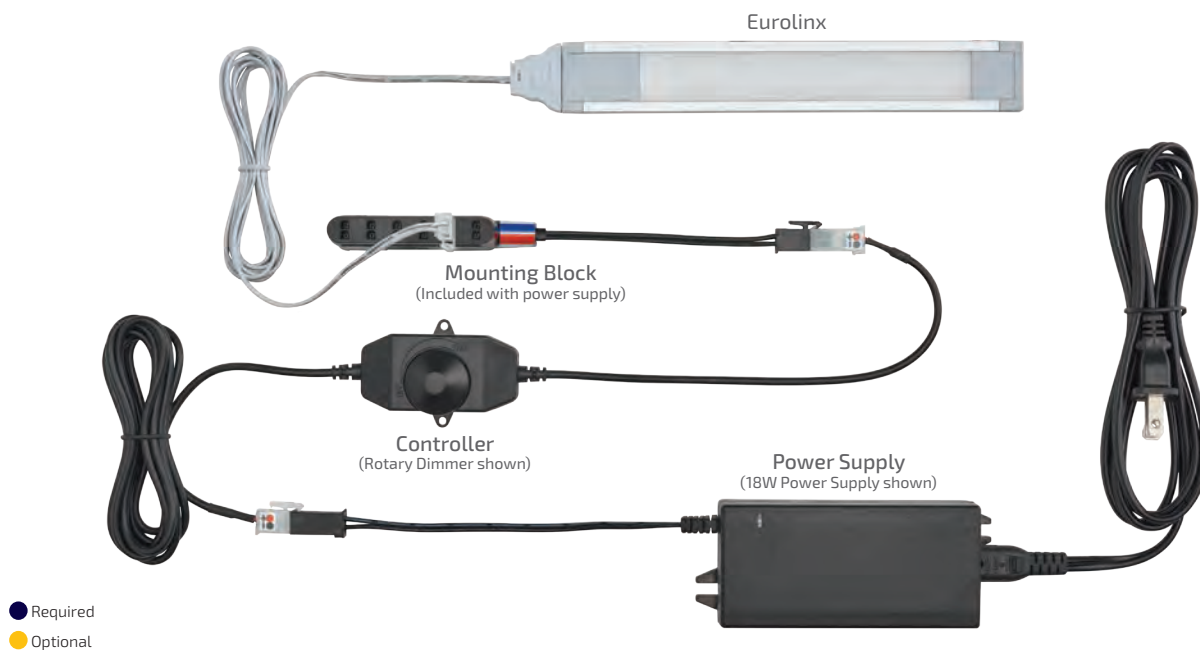

Accessories:



Power Supplies
see power supply section

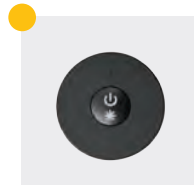

Controllers
see controller section



Eurolinx Touch Dimmer (27 Watt Max)
L-EUL-GTD-1



Eurolinx Cords
L-EULNK-15-WH-1
L-EULNK-25-WH-1
L-EULNK-60-WH-1
L-EULNK-120-WH-1
L-EULNK-180-WH-1

Specifications:

Wattage	Lumens	Efficacy (lm/W)	Input Voltage	Diode Life	Max Per 60W Power Supply	Max Continuous Run	Mounting	Warranty	Beam Angle												
4W/ft. (13.1W/m)	216 per ft. (708 per m)	54	12VDC	50,000 Hours	15' (4.6 m)	10' (3 m)	Surface	5 Year													
Photometric Data					Color Temperature																
		<table border="1"> <thead> <tr> <th>Height</th> <th>Light Output</th> <th>Beam Area</th> </tr> </thead> <tbody> <tr> <td>1ft (.3 m)</td> <td>266.60Fc (2870lx)</td> <td>2.9ft L x 3.3ft W (.88 m L x 1 m W)</td> </tr> <tr> <td>3ft (.9 m)</td> <td>29.62Fc (318.8lx)</td> <td>8.8ft L x 10ft W (2.7 m L x 3 m W)</td> </tr> <tr> <td>6ft (1.8 m)</td> <td>7.40Fc (79.6lx)</td> <td>17.6ft L x 20ft W (5.4 m L x 6 m W)</td> </tr> </tbody> </table>	Height	Light Output	Beam Area	1ft (.3 m)	266.60Fc (2870lx)	2.9ft L x 3.3ft W (.88 m L x 1 m W)	3ft (.9 m)	29.62Fc (318.8lx)	8.8ft L x 10ft W (2.7 m L x 3 m W)	6ft (1.8 m)	7.40Fc (79.6lx)	17.6ft L x 20ft W (5.4 m L x 6 m W)							
Height	Light Output	Beam Area																			
1ft (.3 m)	266.60Fc (2870lx)	2.9ft L x 3.3ft W (.88 m L x 1 m W)																			
3ft (.9 m)	29.62Fc (318.8lx)	8.8ft L x 10ft W (2.7 m L x 3 m W)																			
6ft (1.8 m)	7.40Fc (79.6lx)	17.6ft L x 20ft W (5.4 m L x 6 m W)																			
L-EUL15W-1111CAL-1 Tested																					

See page 66 for part numbers and descriptions

12VDC

Elli® Series

3.6W/ft.
(11.8W/m)

200 Lumens per ft.
(654 per meter)



The patented Elli® Series is available in six lengths and features a square or an angled design that fits easily over glue or staples commonly found in cabinet and casework construction. High-output, wide-angle LEDs and fixture-to-fixture linking capability make for perfect, even illumination.

US PATENT NO: D577,857 and D574,107

Features:

- Wide 120° beam spread
- (2) models: squared and angled
- Available in (6) lengths
- Instant on, instant brightness!
- Linkable
- Sleek and durable aluminum design
- Surface mount

Typical Applications:

- Showcases
- Jewelry cases
- Task lighting
- Store fixtures
- Shelf lighting
- Interior cabinet



Elli® V's patented angled design allows for tight corner mounting



Elli® Z's square design is easy to install and conceal



Linkable up to 12' (3.6 m) continuous run



Available Finishes:



Aluminum (AL)

Dimensions:

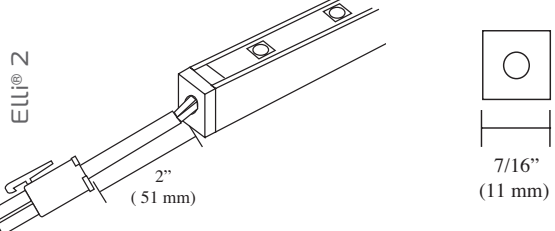
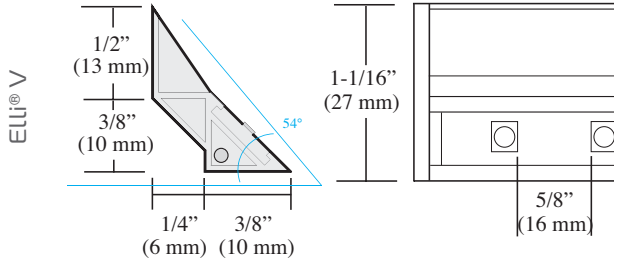

Typical Setup:

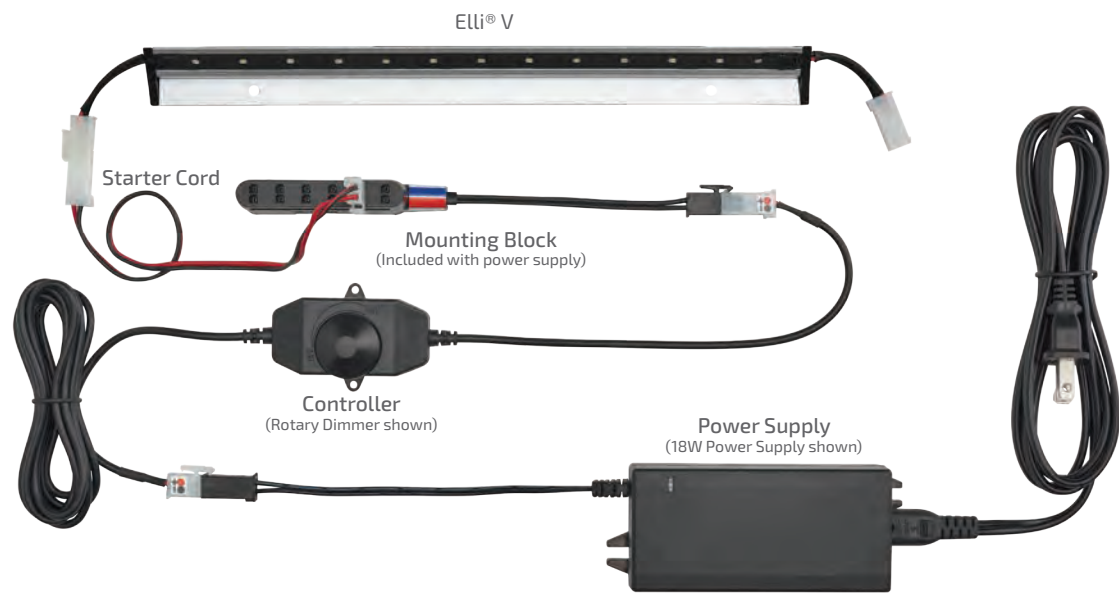

- Required
- Optional

Accessories:



Power Supplies
see power supply section

Starter Cord / Link Cord
L-LED-LINKD-8-1
L-LED-LINKD-15-1
L-LED-LINKD-25-1
L-LED-LINKD-60-1
L-LED-LINKD-120-1
L-LED-LINKD-180-1
L-LED-LINKD-245-1

Controllers
see controller section

Specifications:

Wattage	Lumens	Efficacy (lm/W)	Input Voltage	Diode Life	Max Per 60W Power Supply	Max Continuous Run	Mounting	Warranty	Beam Angle										
3.6W/ft. (11.8W/m)	200 per ft. (654 per m)	55.4	12VDC	50,000 Hours	16' (4.88 m)	12' (3.66 m)	Surface	5 Year											
Photometric Data					Color Temperature														
		<table border="1"> <thead> <tr> <th>Height</th> <th>Light Output</th> <th>Beam Area</th> </tr> </thead> <tbody> <tr> <td>1ft (3 m)</td> <td>282.60Fc (3041.9lx)</td> <td>3ft L x 3ft W (.9 m L x .9 m W)</td> </tr> <tr> <td>3ft (.9 m)</td> <td>31.40Fc (338lx)</td> <td>9ft L x 9ft W (2.7 m L x 2.7 m W)</td> </tr> <tr> <td>6ft (1.8 m)</td> <td>7.85Fc (84.5lx)</td> <td>18ft L x 18.1ft W (5.5 m L x 5.5 m W)</td> </tr> </tbody> </table>	Height	Light Output	Beam Area	1ft (3 m)	282.60Fc (3041.9lx)	3ft L x 3ft W (.9 m L x .9 m W)	3ft (.9 m)	31.40Fc (338lx)	9ft L x 9ft W (2.7 m L x 2.7 m W)	6ft (1.8 m)	7.85Fc (84.5lx)	18ft L x 18.1ft W (5.5 m L x 5.5 m W)					
Height	Light Output	Beam Area																	
1ft (3 m)	282.60Fc (3041.9lx)	3ft L x 3ft W (.9 m L x .9 m W)																	
3ft (.9 m)	31.40Fc (338lx)	9ft L x 9ft W (2.7 m L x 2.7 m W)																	
6ft (1.8 m)	7.85Fc (84.5lx)	18ft L x 18.1ft W (5.5 m L x 5.5 m W)																	
L-LED-SQPR-1016CAL-1 Tested																			

See page 66 for part numbers and descriptions

Economy Series

12VDC

EquiLine SimpLED

4.5W/ft.
(14.8W/m)

214 Lumens
per ft.
(702 per meter)



The patented SimpLED features the unique "three-in-one" system of diffuser options, giving you power to determine glare reflection and intensity. Optional touch, motion or photo/light control modules can be installed in-line or remotely mounted via link cord to further expand your lighting capabilities.

US PATENT NO: 8,545,045

Features:

Clean, flat low-profile aluminum finish – 3/8" (10 mm)

Wide 120° beam spread

Available in (3) lengths – 8" (203 mm), 12" (305 mm) or 22" (559 mm)

Linkable

Optional series of in-line controllers available

Magnets attached to bottom of fixture for metal shelf mounting

Surface mounting options: screw, magnetic, straight and adjustable mounting U-clips

Typical Applications:

Showcases

Displays or store fixtures

Task lighting

Metal shelving

Office furniture

Under cabinet

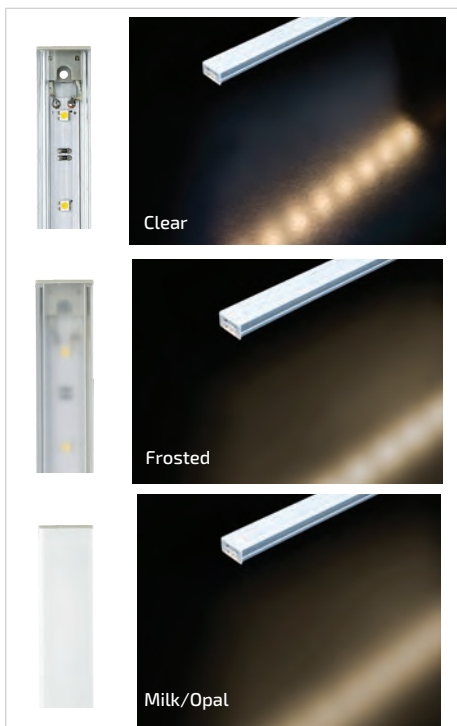

3 diffuser options (included)

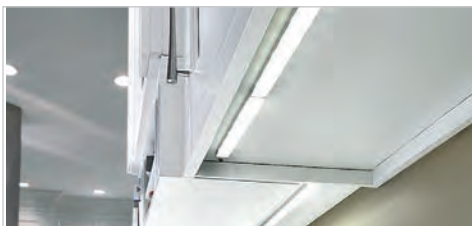

Linkable (back-to-back or link cord) up to 10' (3 m) continuous run



Straight and adjustable mounting U-clips and magnets included



Available Finishes:



Aluminum (AL)

Dimensions:

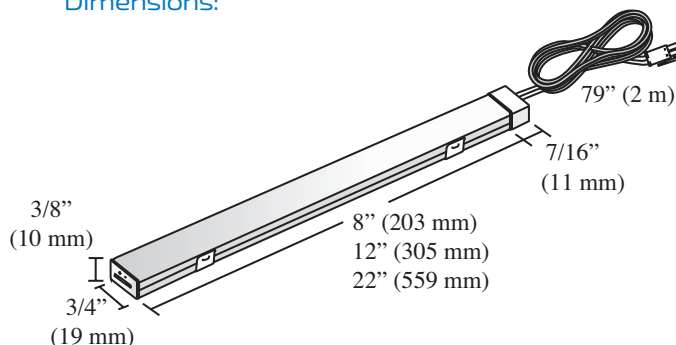



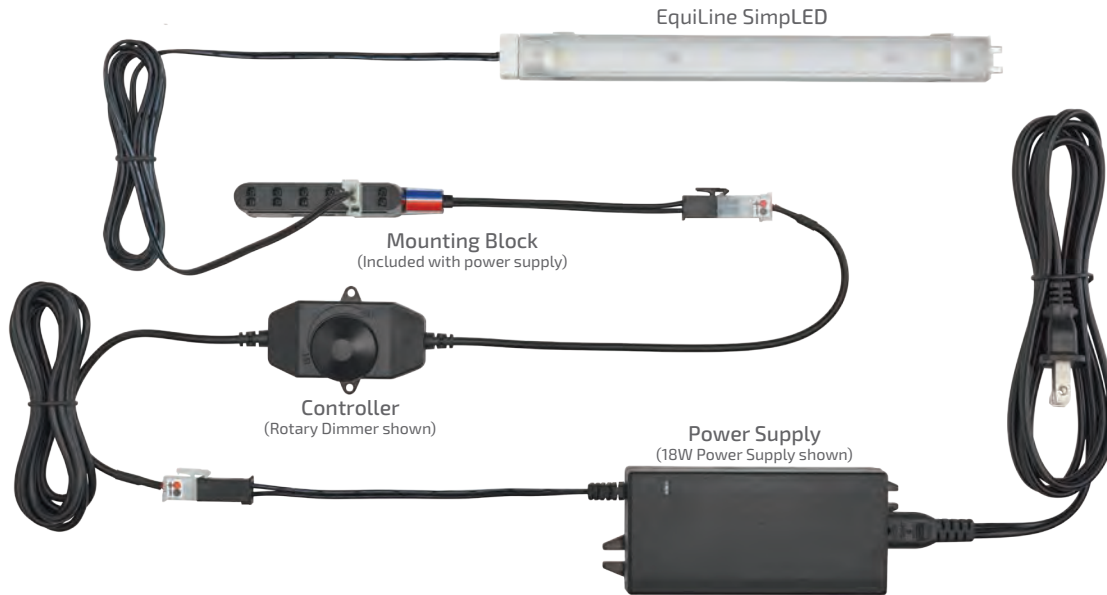

Typical Setup:

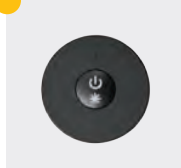

- Required
- Optional

Accessories:

- Required
● Optional

Power Supplies
 see power supply section
- Optional

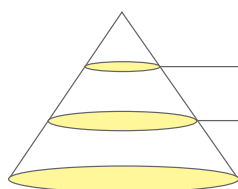
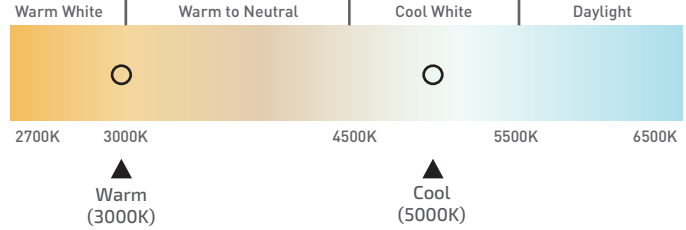
Controllers
 see controller section
- Optional

SimpLED Link Cord
 L-LED-SMPLNK-5-1
 L-LED-SMPLNK-15-1
 L-LED-SMPLNK-25-1
 L-LED-SMPLNK-60-1
 L-LED-SMPLNK-120-1
 L-LED-SMPLNK-180-1
- Optional

Rectangle Inline Touch Dimmer (27 Watt Max)
 L-LED-SMPTD4-1
- Optional

Rectangle Inline Motion Sensor (27 Watt Max)
 L-LED-SMPMOT-1

Specifications:

Wattage	Lumens	Efficacy (lm/W)	Input Voltage	Diode Life	Max Per 60W Power Supply	Max Continuous Run	Mounting	Warranty	Beam Angle
4.5W/ft. (14.8W/m)	214 per ft. (702 per m)	124	12VDC	50,000 Hours	13' (3.96 m)	10' (3.04 m)	Surface	3 Year	
Photometric Data					Color Temperature				
		Height	Light Output	Beam Area					
		1ft (3m)	86.4Fc (930lx)	2.2ft L x 2.9ft W (.67 m L x .88 m W)					
		3ft (.9m)	9.6Fc (103.3lx)	6.6ft L x 8.8ft W (2 m L x 2.7 m W)					
		6ft (1.8 m)	2.40Fc (25.8lx)	13.1ft L x 17.6ft W (4 m L x 5.4 m W)					
L-LED-SMP12-CNI-1 Tested									

See page 65 for part numbers and descriptions

Economy Series

12VDC

EquiLine FineLine

2.4W/ft.
(7.9W/m)

297 Lumens
per ft.
(971 per meter)



Long and narrow, FineLine is the unobtrusive way to provide smooth, linear lighting almost anywhere. The low profile design features a frosted diffuser for even illumination and with optional manual or remote control dimmers, creating the perfect atmosphere is effortless.

Features:

Extremely thin, low-profile design – 5/16" (8 mm)

90° beam spread

Available in (3) lengths – 8" (203 mm), 12" (305 mm) or 22" (559 mm)

Linkable

Frosted diffuser

79" (2 m) starter cord included

Surface mount

Typical Applications:

Shelving

Displays or store fixtures

Interior and under cabinets

Food service equipment



Available Finishes:



Aluminum (AL)

Dimensions:



8" (203 mm)

12" (305 mm)

22" (559 mm)

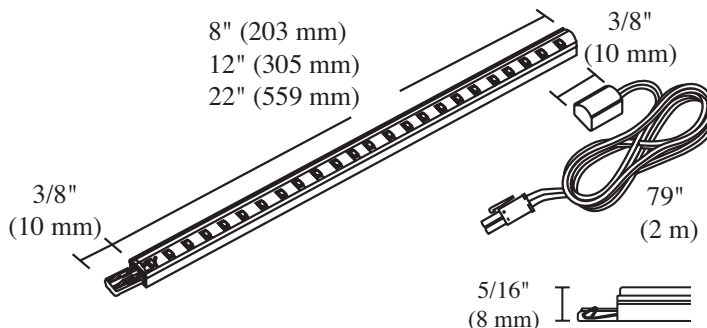

Optional in-line touch dimmer available (4-step: low-medium-high-off)



Linkable (back-to-back or link cord) up to 12' (3.66 m) continuous run



Straight and adjustable mounting U-Clips included

Typical Setup:

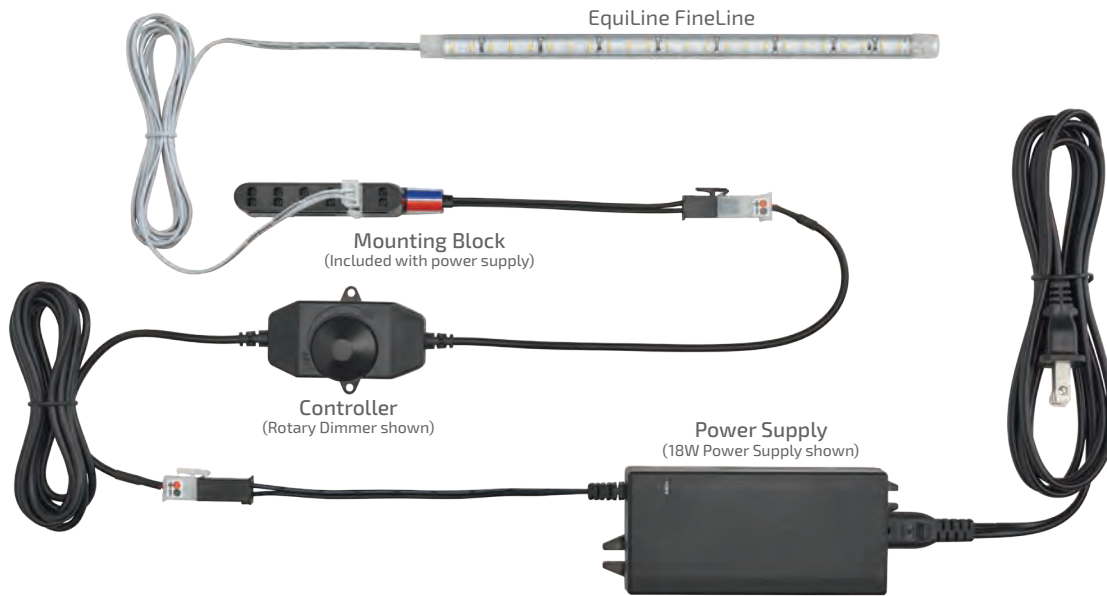

- Required
- Optional

Accessories:

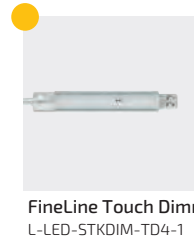
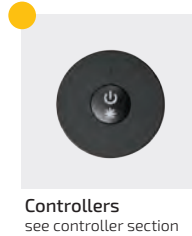

Specifications:

Wattage	Lumens	Efficacy (lm/W)	Input Voltage	Diode Life	Max Per 60W Power Supply	Max Continuous Run	Mounting	Warranty	Beam Angle												
2.4 W/ft. (7.9W/m)	297 per ft. (971 per m)	124	12VDC	50,000 Hours	24' (7.32 m)	12' (3.66 m)	Surface	3 Year													
Photometric Data					Color Temperature																
<table border="1"> <thead> <tr> <th>Height</th> <th>Light Output</th> <th>Beam Area</th> </tr> </thead> <tbody> <tr> <td>1ft (.3 m)</td> <td>284Fc (3056.9lx)</td> <td>3.2ft L x 1.7ft W (.97 m L x .52 m W)</td> </tr> <tr> <td>3ft (.9 m)</td> <td>31.5Fc (339.1lx)</td> <td>6.3ft L x 3.3ft W (1.9 m L x 1 m W)</td> </tr> <tr> <td>6ft (1.8 m)</td> <td>7.88Fc (84.8lx)</td> <td>19ft L x 9.9ft W (5.7 m L x 3 m W)</td> </tr> </tbody> </table> <p>L-LED-STK22-CNI-1 Tested</p>					Height	Light Output	Beam Area	1ft (.3 m)	284Fc (3056.9lx)	3.2ft L x 1.7ft W (.97 m L x .52 m W)	3ft (.9 m)	31.5Fc (339.1lx)	6.3ft L x 3.3ft W (1.9 m L x 1 m W)	6ft (1.8 m)	7.88Fc (84.8lx)	19ft L x 9.9ft W (5.7 m L x 3 m W)	<p>Warm White Warm to Neutral Cool White Daylight</p> <p>2700K 3000K 4500K 5500K 6500K</p> <p>▲ Warm (3000K) ▲ Cool (5000K)</p>				
Height	Light Output	Beam Area																			
1ft (.3 m)	284Fc (3056.9lx)	3.2ft L x 1.7ft W (.97 m L x .52 m W)																			
3ft (.9 m)	31.5Fc (339.1lx)	6.3ft L x 3.3ft W (1.9 m L x 1 m W)																			
6ft (1.8 m)	7.88Fc (84.8lx)	19ft L x 9.9ft W (5.7 m L x 3 m W)																			

See page 64 for part numbers and descriptions

T5 Trescent® LED

120V

4.3W/ft.
(14W/m)

295 Lumens
per ft.
(967 per meter)



Look again — that's not a fluorescent, that's a LED Linear Light. The T5 LED has the same low profile as fluorescent strip lights without the harmful material, costly energy consumption or bulb replacement and breakage. While fluorescent bulbs produce uneven light, the T5 LED Series produces even light throughout the length of the fixture, giving off 20 percent more light than other brands.

Features:

Luniform output – no “dots”

Available in (6) lengths

Slim end cap design eliminates dark spots when linking

Averages 30% less energy consumption than fluorescent equivalent

No hum or flicker as found in similar fluorescent lights

Instant on, instant brightness!

Integrated on/off switch

Typical Applications:

Displays

Office furniture

Cabinets or shelving

Laboratory furniture

Backlighting

Soffit, perimeter lighting or cove lighting



Integrated on/off switch, proprietary diffuser to eliminate dotted appearance



6' (1.8 m) starter cord, mounting clips, back-to-back connectors and 90° connectors included



Linkable up to 150W or 10 fixtures

Available Finishes:



Black (BL)



White (WH)



Dimensions:

Power Cord

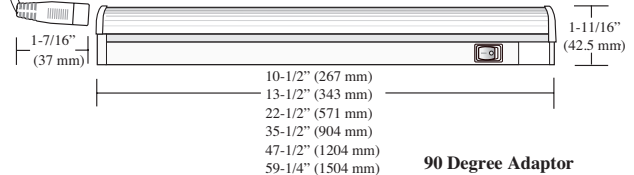

90 Degree Adaptor

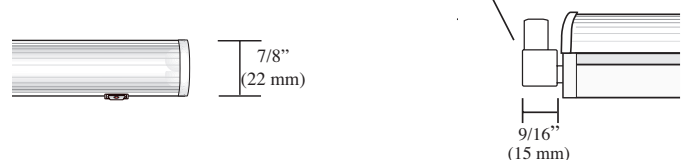

Typical Setup:

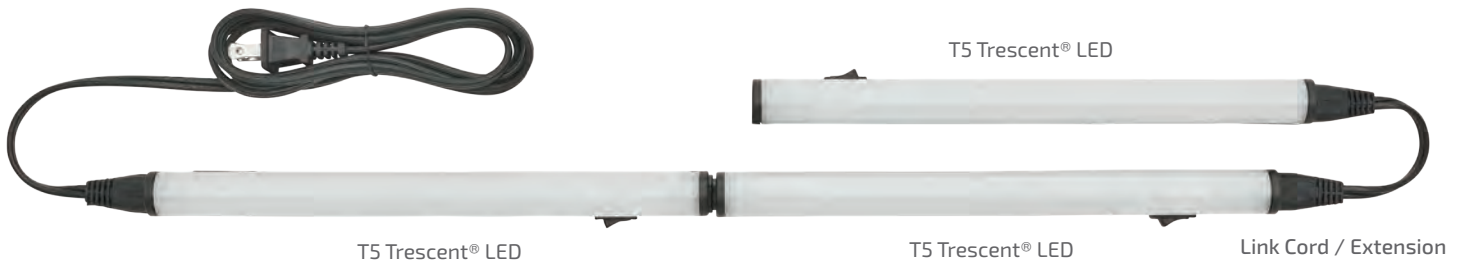

● Required

● Optional

Accessories:



Hardwire Boxes
 L-HWB-WH-T5-1
 L-HWB-BL-T5-1
 L-HWB-WH-T5-S-1
 L-HWB-BL-T5-S-1



Hardwire Box Adaptor
 L-LTS-HWBADP-BL-1
 L-LTS-HWBADP-WH-1



U Clips - Metal
 L-TR55-UCLP-M-1

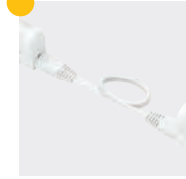

Link Cord / Extension
 L-LTS-LNK15-BL-1
 L-LTS-LNK15-WH-1
 L-LTS-LNK25-BL-1
 L-LTS-LNK25-WH-1
 L-LTS-LNK60-BL-1
 L-LTS-LNK60-WH-1
 L-LTS-LNK120-BL-1
 L-LTS-LNK120-WH-1
 L-LTS-LNK180-BL-1
 L-LTS-LNK180-WH-1

Specifications:

Wattage	Lumens	Efficacy (lm/W)	Input Voltage	Diode Life	Max Continuous Run	Mounting	Warranty	Beam Angle												
4.3W/ft. (14W/m)	295 per ft. (967 per m)	68.6	120V	30,000 Hours	10 Fixtures or up to 150W	Surface	3 Year													
Photometric Data					Color Temperature															
<table border="1"> <thead> <tr> <th>Height</th> <th>Light Output</th> <th>Beam Area</th> </tr> </thead> <tbody> <tr> <td>1ft (.3 m)</td> <td>318.50Fc (3428.30lx)</td> <td>2.6ft L x 15.3ft W (.8 m L x 4.7 m W)</td> </tr> <tr> <td>3ft (.9 m)</td> <td>35.39Fc (380.93lx)</td> <td>7.9ft L x 45.8ft W (2.4 m L x 14 m W)</td> </tr> <tr> <td>6ft (1.8 m)</td> <td>8.85Fc (95.26lx)</td> <td>15.8ft L x 91.6ft W (4.8 m L x 27.9 m W)</td> </tr> </tbody> </table> <p>L-LTS18W-1204CWH-1 Tested</p>					Height	Light Output	Beam Area	1ft (.3 m)	318.50Fc (3428.30lx)	2.6ft L x 15.3ft W (.8 m L x 4.7 m W)	3ft (.9 m)	35.39Fc (380.93lx)	7.9ft L x 45.8ft W (2.4 m L x 14 m W)	6ft (1.8 m)	8.85Fc (95.26lx)	15.8ft L x 91.6ft W (4.8 m L x 27.9 m W)	<p>Warm White Warm to Neutral Cool White Daylight</p> <p>2700K 3000K 4500K 5500K 6500K</p> <p>▲ Warm (3000K) ▲ Cool (5000K) ▲ Daylight (6500K)</p>			
Height	Light Output	Beam Area																		
1ft (.3 m)	318.50Fc (3428.30lx)	2.6ft L x 15.3ft W (.8 m L x 4.7 m W)																		
3ft (.9 m)	35.39Fc (380.93lx)	7.9ft L x 45.8ft W (2.4 m L x 14 m W)																		
6ft (1.8 m)	8.85Fc (95.26lx)	15.8ft L x 91.6ft W (4.8 m L x 27.9 m W)																		

See page 68 for part numbers and descriptions

● 12VDC FineLine 2.0 LED Series

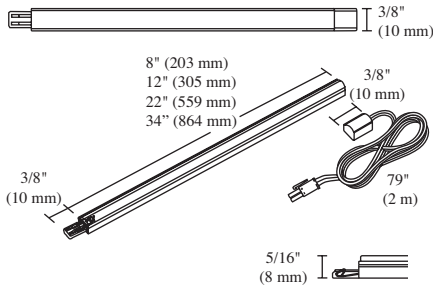

Part #	Description
L-STKH08-CNI-1	8" (203 mm) Fineline 2.0, 5000K, Nickel
L-STKH012-CNI-1	12" (305 mm) Fineline 2.0, 5000K, Nickel
L-STKH022-CNI-1	22" (559 mm) Fineline 2.0, 5000K, Nickel
L-STKH034-CNI-1	34" (864 mm) Fineline 2.0, 5000K, Nickel
L-STKH08-WNI-1	8" (203 mm) Fineline 2.0, 3000K, Nickel
L-STKH012-WNI-1	12" (305 mm) Fineline 2.0, 3000K, Nickel
L-STKH022-WNI-1	22" (559 mm) Fineline 2.0, 3000K, Nickel
L-STKH034-WNI-1	34" (864 mm) Fineline 2.0, 3000K, Nickel

Maximum continuous run of 12 ft. (3.7 m) to prevent voltage drop. Maximum 13 ft. (4 m) per 60W power supply. 79" (2 m) Starter Cord, AMP® Connector and mounting U-Clips are included with each light.

● 12VDC EquiLine FineLine LED Series

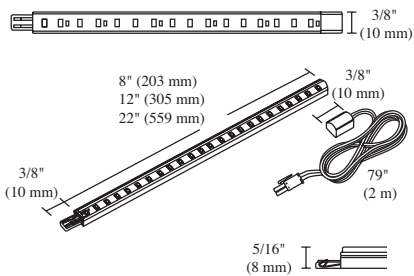

Part #	Description
L-LED-STK8-CNI-1	8" (203 mm) EquiLine Fineline, 5000K, Nickel
L-LED-STK12-CNI-1	12" (305 mm) EquiLine Fineline, 5000K, Nickel
L-LED-STK22-CNI-1	22" (559 mm) EquiLine Fineline, 5000K, Nickel
L-LED-STK8-WNI-1	8" (203 mm) EquiLine Fineline, 3000K, Nickel
L-LED-STK12-WNI-1	12" (305 mm) EquiLine Fineline, 3000K, Nickel
L-LED-STK22-WNI-1	22" (559 mm) EquiLine Fineline, 3000K, Nickel

Maximum continuous run of 12 ft. (3.7 m) to prevent voltage drop. Maximum 24 ft. (7.3 m) per 60W power supply. 79" (2 m) Starter Cord, AMP® Connector and mounting U-Clips are included with each light.

● 12VDC FineLine Link Cord

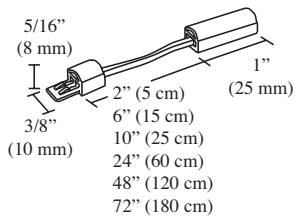

Part #	Description
L-LED-STKLNK-5-1	5 cm (2") 12VDC Stick Linking Cord
L-LED-STKLNK-15-1	15 cm (6") 12VDC Stick Linking Cord
L-LED-STKLNK-25-1	25 cm (10") 12VDC Stick Linking Cord
L-LED-STKLNK-60-1	60 cm (24") 12VDC Stick Linking Cord
L-LED-STKLNK-120-1	120 cm (48") 12VDC Stick Linking Cord
L-LED-STKLNK-180-1	180 cm (72") 12VDC Stick Linking Cord

● 12VDC FineLine Touch Dimmer

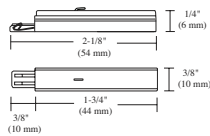

Part #	Description
L-LED-STKDIM-TD4-1	Inline Touch Dimmer, 4 Step

Controls up to 6 ft. (1.8 m) of FineLine 2.0 lights and 10 ft. (3 m) of EquiLine FineLine lights.



COMPONENTS: POWER SUPPLIES, CONTROLLERS AND MORE SEE PAGE 141.

● 12VDC SimplLED 2.0 Series

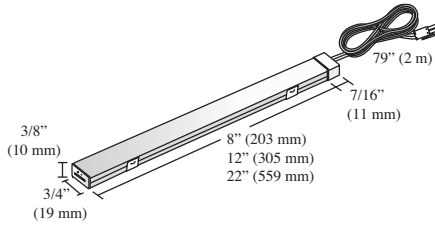

Part #	Description
L-SMPHO8-CNI-1	8" (203 mm) 12VDC SimplLED 2.0, 5000K Nickel
L-SMPHO12-CNI-1	12" (305 mm) 12VDC SimplLED 2.0, 5000K Nickel
L-SMPHO22-CNI-1	22" (559 mm) 12VDC SimplLED 2.0, 5000K Nickel
L-SMPHO8-WNI-1	8" (203 mm) 12VDC SimplLED 2.0, 3000K Nickel
L-SMPHO12-WNI-1	12" (305 mm) 12VDC SimplLED 2.0, 3000K Nickel
L-SMPHO22-WNI-1	22" (559 mm) 12VDC SimplLED 2.0, 3000K Nickel

Maximum continuous run 10 ft. (3 m) to prevent voltage drop. Maximum 12 ft. (3.6 m) per power supply.
79" (2 m) Starter Cord, AMP® Connector, H-Shaped Connector, and Mounting U-Clips are included with each light.
3 diffusers (Clear, Frosted and Milk/Opal) are included with each light.

● 12VDC EquiLine SimplLED Series

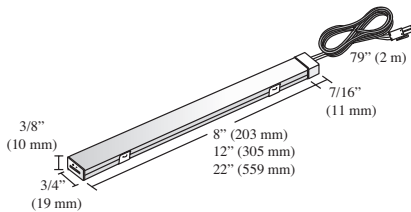

Part #	Description
L-LED-SMP8-CNI-1	8" (203 mm) EquiLine SimplLED, 5000K, Nickel,
L-LED-SMP12-CNI-1	12" (305 mm) EquiLine SimplLED, 5000K, Nickel
L-LED-SMP22-CNI-1	22" (559 mm) EquiLine SimplLED, 5000K, Nickel
L-LED-SMP8-WNI-1	8" (203 mm) EquiLine SimplLED, 3000K, Nickel,
L-LED-SMP12-WNI-1	12" (305 mm) EquiLine SimplLED, 3000K, Nickel
L-LED-SMP22-WNI-1	22" (559 mm) EquiLine SimplLED, 3000K, Nickel

Maximum continuous run 10 ft. (3 m) to prevent voltage drop. Maximum 13 ft. (3.7 m) per 60W power supply.
79" (2 m) Starter Cord, AMP® Connector, H-Shaped Connector, and mounting U-Clips are included with each light.
3 diffusers (Clear, Frosted and Milk/Opal) are included with each light.

● 12VDC SimplLED Link Cord

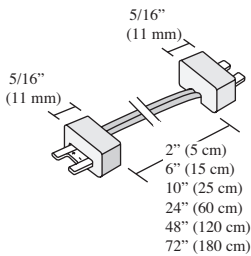

Part #	Description
L-LED-SMPLNK-5-1	5 cm (2") 12VDC SimplLED Linking Cord
L-LED-SMPLNK-15-1	15 cm (6") 12VDC SimplLED Linking Cord
L-LED-SMPLNK-25-1	25 cm (10") 12VDC SimplLED Linking Cord
L-LED-SMPLNK-60-1	60 cm (24") 12VDC SimplLED Linking Cord
L-LED-SMPLNK-120-1	120 cm (48") 12VDC SimplLED Linking Cord
L-LED-SMPLNK-180-1	180 cm (72") 12VDC SimplLED Linking Cord

● 12VDC SimplLED Control Modules

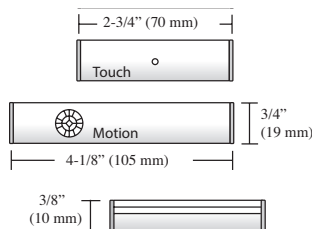

Part #	Description
L-LED-SMPTD4-1	27W Rectangle Inline Touch Dimmer
L-LED-SMPMOT-1	27W Rectangle Inline Motion Sensor

Controls up to 5.4 ft. (1.6 m) of SimplLED 2.0 lights and 6.0 ft. (1.8 m) of EquiLine SimplLED lights.
Max load 27W.



COMPONENTS: POWER SUPPLIES, CONTROLLERS AND MORE SEE PAGE 141.

● 12VDC Eurolinx Series

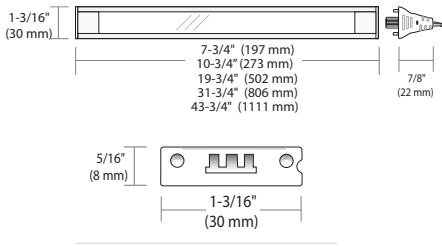

Part #	Description
L-EUL3W-197CAL-1	197 mm (7.75") 12VDC 3W Eurolinx 5000K
L-EUL4W-273CAL-1	273 mm (10-3/4") 12VDC 4W Eurolinx 5000K
L-EUL7W-502CAL-1	502 mm (19-3/4") 12VDC 7W Eurolinx 5000K
L-EUL11W-806CAL-1	806 mm (31-3/4") 12VDC 11W Eurolinx 5000K
L-EUL15W-1111CAL-1	1111 mm (43-3/4") 12VDC 15W Eurolinx 5000K
L-EUL3W-197WAL-1	197 mm (7.75") 12VDC 3W Eurolinx 3000K
L-EUL4W-273WAL-1	273 mm (10-3/4") 12VDC 4W Eurolinx 3000K
L-EUL7W-502WAL-1	502 mm (19-3/4") 12VDC 7W Eurolinx 3000K
L-EUL11W-806WAL-1	806 mm (31-3/4") 12VDC 11W Eurolinx 3000K
L-EUL15W-1111WAL-1	1111 mm (43-3/4") 12VDC 15W Eurolinx 3000K

Maximum continuous run 10 ft. (3 m) to prevent voltage drop. Maximum 15 ft. (4.6 m) per 60W power supply. Each light includes 79" (2 m) cord, U-Clips, back to back connector.

● 12VDC Euro Link Cord

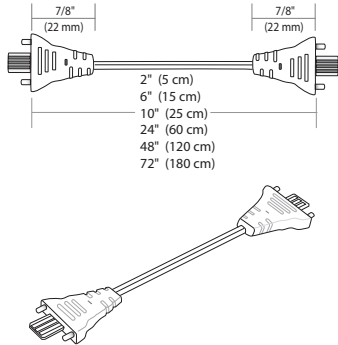

Part #	Description
L-EULNK-15-WH-1	15 cm (6") Eurolinx Linking Cord, White
L-EULNK-25-WH-1	25 cm (10") Eurolinx Linking Cord, White
L-EULNK-60-WH-1	60 cm (24") Eurolinx Linking Cord, White
L-EULNK-120-WH-1	120 cm (48") Eurolinx Linking Cord, White
L-EULNK-180-WH-1	180 cm (72") Eurolinx Linking Cord, White

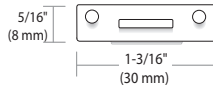

● 12VDC Eurolinx Touch Dimmer

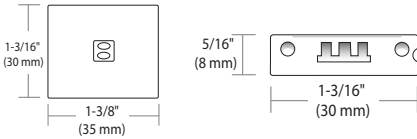

Part #	Description
L-EUL-GTD-1	27W Eurolinx Gradual Inline Touch Dimmer

Controls up to 6.75 ft. (2 m) of Eurolinx Lights. Max load 27W.

● 12VDC Elli® V Series

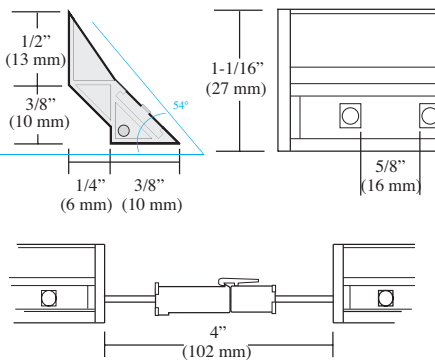

Part #	Description
L-LED-AGLPR-250CAL-1	279 mm (11") Elli® V LED, 4800K, Aluminum
L-LED-AGLPR-406CAL-1	432 mm (17") Elli® V LED, 4800K, Aluminum
L-LED-AGLPR-711CAL-1	737 mm (29") Elli® V LED, 4800K, Aluminum
L-LED-AGLPR-1016CAL-1	1041 mm (41") Elli® V LED, 4800K, Aluminum
L-LED-AGLPR-250WAL-1	279 mm (11") Elli® V LED, 3500K, Aluminum
L-LED-AGLPR-406WAL-1	432 mm (17") Elli® V LED, 3500K, Aluminum
L-LED-AGLPR-559WAL-1	584 mm (23") Elli® V LED, 3500K, Aluminum
L-LED-AGLPR-711WAL-1	737 mm (29") Elli® V LED, 3500K, Aluminum
L-LED-AGLPR-864WAL-1	889 mm (35") Elli® V LED, 3500K, Aluminum
L-LED-AGLPR-1016WAL-1	1041 mm (41") Elli® V LED, 3500K, Aluminum

Maximum continuous run 12 ft. (3.65 m) to prevent voltage drop. 16 ft. (4.88 m) maximum per power supply.



COMPONENTS: POWER SUPPLIES, CONTROLLERS AND MORE SEE PAGE 141.

● 12VDC Elli 2 Series

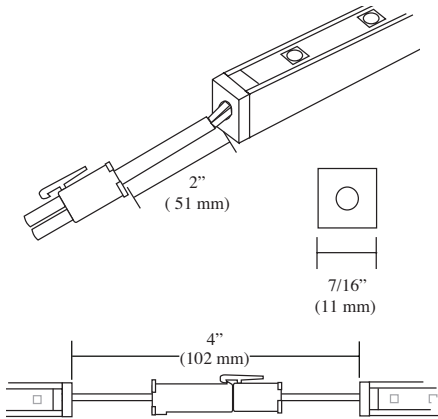

Part #	Description
L-LED-SQPR-250CAL-1	279 mm (11") Elli® 2 LED, 4800K, Aluminum
L-LED-SQPR-559CAL-1	584 mm (23") Elli® 2 LED, 4800K, Aluminum
L-LED-SQPR-864CAL-1	889 mm (35") Elli® 2 LED, 4800K, Aluminum
L-LED-SQPR-1016CAL-1	1041 mm (41") Elli® 2 LED, 4800K, Aluminum
L-LED-SQPR-250WAL-1	279 mm (11") Elli® 2 LED, 3500K, Aluminum
L-LED-SQPR-406WAL-1	432 mm (17") Elli® 2 LED, 3500K, Aluminum
L-LED-SQPR-559WAL-1	584 mm (23") Elli® 2 LED, 3500K, Aluminum
L-LED-SQPR-711WAL-1	737 mm (29") Elli® 2 LED, 3500K, Aluminum
L-LED-SQPR-864WAL-1	889 mm (35") Elli® 2 LED, 3500K, Aluminum
L-LED-SQPR-1016WAL-1	1041 mm (41") Elli® 2 LED, 3500K, Aluminum

Maximum continuous run 12 ft. (3.65 m) to prevent voltage drop. 16 ft. (4.88 m) maximum per power supply.

● 12VDC Starter Cord / Link Cord

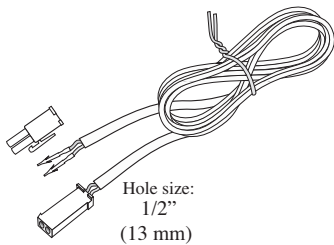

Part #	Description
L-LED-LINKD-8-1	8 cm (3") 12VDC Starter/Link/Extension Cord
L-LED-LINKD-15-1	15 cm (6") 12VDC Starter/Link/Extension Cord
L-LED-LINKD-25-1	25 cm (10") 12VDC Starter/Link/Extension Cord
L-LED-LINKD-60-1	60 cm (24") 12VDC Starter/Link/Extension Cord
L-LED-LINKD-120-1	120 cm (48") 12VDC Starter/Link/Extension Cord
L-LED-LINKD-180-1	180 cm (72") 12VDC Starter/Link/Extension Cord
L-LED-LINKD-245-1	245 cm (96") 12VDC Starter/Link/Extension Cord

● 12VDC Power Supplies



For details see
Power Supplies
on Page 142.

Part #	Description
L-DC-ELT18-CON-1	18W 12VDC Power Supply w/6 Snap Mounting Block*
L-DC-SLELT30-1	30W 12VDC Power Supply w/6 Snap Mounting Block*
L-DC-SLELT60-1	60W 12VDC Power Supply w/6 Snap Mounting Block*
L-DC-ELT6WP-CON-1	6W 12VDC Wall Mount Power Supply w/3 Snap Block*
L-DC-ELT15WP-CON-1	15W 12VDC Wall Mount Power Supply w/6 Snap Block*
L-DC-EQ30-1	30W 12VDC Equiline Power Supply w/6 Snap Block*
L-DC-EQ60-1	60W 12VDC Equiline Power Supply w/6 Snap Block*
L-DCE30D-CON-1	30W 12VDC Hardwire Dimmable LED Power Supply†
L-DCE60D-CON-1	60W 12VDC Hardwire Dimmable LED Power Supply†
L-12DCH60X1-1	60W 12VDC Commercial/Industrial Metal Hardwire Dimmable Power Supply‡
L-12DCH60X3-1	180W 12VDC Commercial/Industrial Metal Hardwire Dimmable Power Supply‡

* Dimmable on trailing edge (12VDC side). Mounting block and power cord are included.

† Dimmable by LED line voltage (120V) wall dimmers. Mounting block included.

‡ Dimmable by LED line voltage (120V) wall dimmers. Mounting block not included

All hardwire power supplies require an electrician for install.



COMPONENTS: POWER SUPPLIES, CONTROLLERS AND MORE SEE PAGE 141.

- Required
- Optional

● 120V T5 Trescent® LED Series

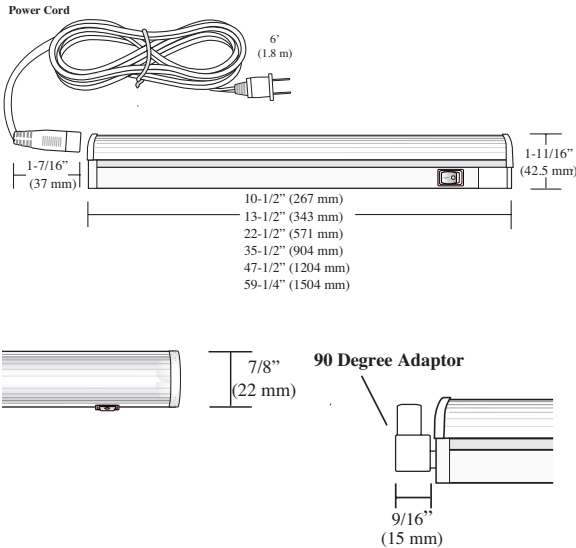

Part #	Description
L-LT53W-267D*-1	T5 LED 3W 6500K 10.5" (267 mm)
L-LT53W-267C*-1	T5 LED 3W 5000K 10.5" (267 mm)
L-LT53W-267W*-1	T5 LED 3W 3000K 10.5" (267 mm)
L-LT54W-343D*-1	T5 LED 4W 6500K 13.5" (343 mm)
L-LT54W-343C*-1	T5 LED 4W 5000K 13.5" (343 mm)
L-LT54W-343W*-1	T5 LED 4W 3000K 13.5" (343 mm)
L-LT57W-571D*-1	T5 LED 7W 6500K 22.5" (571 mm)
L-LT57W-571C*-1	T5 LED 7W 5000K 22.5" (571 mm)
L-LT57W-571W*-1	T5 LED 7W 3000K 22.5" (571 mm)
L-LT514W-904D*-1	T5 LED 14W 6500K 35.5" (904 mm)
L-LT514W-904C*-1	T5 LED 14W 5000K 35.5" (904 mm)
L-LT514W-904W*-1	T5 LED 14W 3000K 35.5" (904 mm)
L-LT518W-1204D*-1	T5 LED 18W 6500K 47.5" (1204 mm)
L-LT518W-1204C*-1	T5 LED 18W 5000K 47.5" (1204 mm)
L-LT518W-1204W*-1	T5 LED 18W 3000K 47.5" (1204 mm)
L-LT525W-1504D*-1	T5 LED 25W 6500K 59.25" (1504 mm)
L-LT525W-1504C*-1	T5 LED 25W 5000K 59.25" (1504 mm)
L-LT525W-1504W*-1	T5 LED 25W 3000K 59.25" (1504 mm)

*For white fixture use (WH), for black use (BL).
6 ft. (1.8 m) starter cord, straight and 90° U-Clips, back-to-back connector and 90° Adaptor included.

● 120V Hardwire Boxes

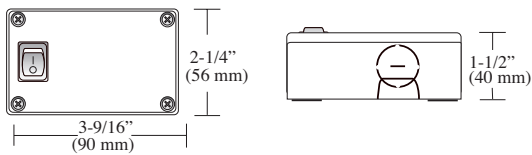

Part #	Description
L-HWB-WH-T5-1	T5 White Hardwire Box, without Switch
L-HWB-BL-T5-1	T5 Black Hardwire Box, without Switch
L-HWB-WH-T5-S-1	T5 White Hardwire Box, with Switch
L-HWB-BL-T5-S-1	T5 Black Hardwire Box, with Switch

*Adaptor cord is required for proper connection.

● 120V Hardwire Box Adaptor



Part #	Description
L-LT5-HWBADP-BL-1	T5 LED Hardwire Box Adaptor, Black
L-LT5-HWBADP-WH-1	T5 LED Hardwire Box Adaptor, White

● U Clips - Metal

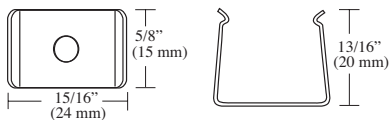

Part #	Description
L-TR55-UCLP-M-1	Metal T5 Replacement U-clips, Set of 2

● 120V Link Cord / Extension

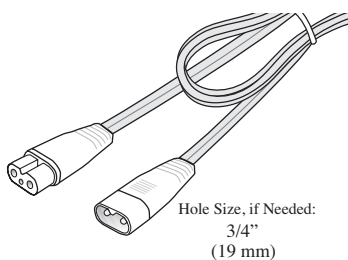

Part #	Description
L-LT5-LNK15-BL-1	6" (15 cm) Black T5 Trescent® LED Linking Cord
L-LT5-LNK15-WH-1	6" (15 cm) White T5 Trescent® LED Linking Cord
L-LT5-LNK25-BL-1	10" (25 cm) Black T5 Trescent® LED Linking Cord
L-LT5-LNK25-WH-1	10" (25 cm) White T5 Trescent® LED Linking Cord
L-LT5-LNK60-BL-1	24" (60 cm) Black T5 Trescent® LED Linking Cord
L-LT5-LNK60-WH-1	24" (60 cm) White T5 Trescent® LED Linking Cord
L-LT5-LNK120-BL-1	48" (120 cm) Black T5 Trescent® LED Linking Cord
L-LT5-LNK120-WH-1	48" (120 cm) White T5 Trescent® LED Linking Cord
L-LT5-LNK180-BL-1	72" (180 cm) Black T5 Trescent® LED Linking Cord
L-LT5-LNK180-WH-1	72" (180 cm) White T5 Trescent® LED Linking Cord



Photo by Ronnie Wood



Single
Color

















12VDC
24V DC

TAPE

TAPE

Single Color FlexTape® At a Glance

All tape measured at 1' lengths.

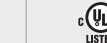
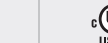
	1.5W FlexTape®	3W FlexTape®	4.4W FlexTape®	5.5W FlexTape®	COB FlexTape® 12VDC/ 24VDC	Edge Emitting FlexTape®	1.5W Equiline Tape	3W Equiline Tape	4.4W Equiline Tape
Tape Width	10 mm	10 mm	10 mm	10 mm	10 mm	10 mm	10 mm	10 mm	10 mm
Roll Length	20'	16.4'	13'	10'	13'/16.4'	16.4'	20'	16.4'	13'
Wattage	1.5W/ft.	3W/ft.	4.4W/ft.	5.5W/ft.	4.4W/ft. 5.5W/ft.	2.5W/ft.	1.5W/ft.	3W/ft.	4.4W/ft.
Lumens/ft.	150	365	420	615	245/420	195	135	255	395
Input Voltage	12VDC	12VDC	12VDC	12VDC	12VDC/24VDC	12VDC	12VDC	12VDC	12VDC
Beam Angle									
Max Continuous Run	20'	16.4'	13'	10'	13'/16.4'	16.4'	20'	16.4'	13'
Diode Life	50,000	50,000	50,000	50,000	50,000	50,000	25,000	25,000	25,000
CRI	>90	>90	>90	>90	>90	>83	>83	>83	>83
Warranty	5 years	5 years	5 years	5 years	5 years	5 years	2 years	2 years	2 years
Safety Certifications									
Color Temperatures	2700, 3000, 3500, 4800, 6500, Red, Blue	2700, 3000, 3500, 4800, 6500, Red, Blue	2700, 3000, 3500, 4800, 6500	2700, 3000, 3500, 4800, 6500	2700, 3000, 3500, 4800, 6500	2700, 3500, 4800, 6500	2700, 3000, 3500, 4800, 6500	2700, 3000, 3500, 4800, 6500	2700, 3000, 3500, 4800, 6500
Dimmable	Yes	Yes	Yes	Yes	Yes	Yes	Yes	Yes	Yes

Note: Above chart represents averages per foot. Many factors can affect actual output.

12VDC

24VDC

Tape



Tape System Overview

A unique design makes our Tape Lighting the most versatile LED light on earth. Curve them under frosted glass to create a stunning display or run them under shelving for continuous illumination. The tape features an adhesive backing for easy peel-and-stick installation.

Features:

- No soldering required - simple FlexConnect connectors
- White color printed board maximizes light output
- Lower heat, longer life than competing brands
- Available in multiple color temperatures and colors
- Cutttable and linkable
- Can be used with Infinex Series

Typical Applications:

- Store fixtures
- Edge lighting
- Backlighting
- Accent lighting
- Cove lighting
- Toe kick
- Soffit

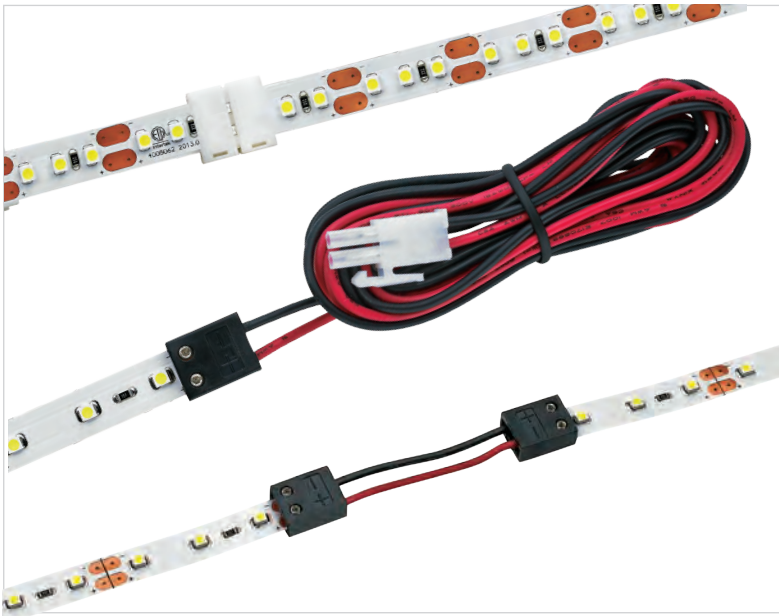

Easy to use FlexConnect system with reliable connections



Strong adhesive backing



Sold by the roll

Typical Setup:

12VDC

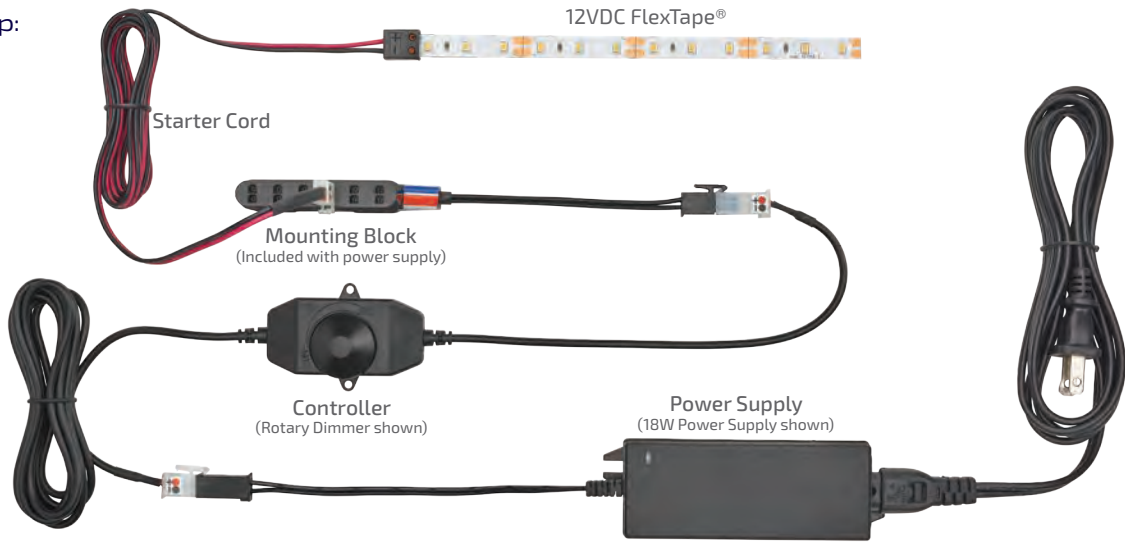



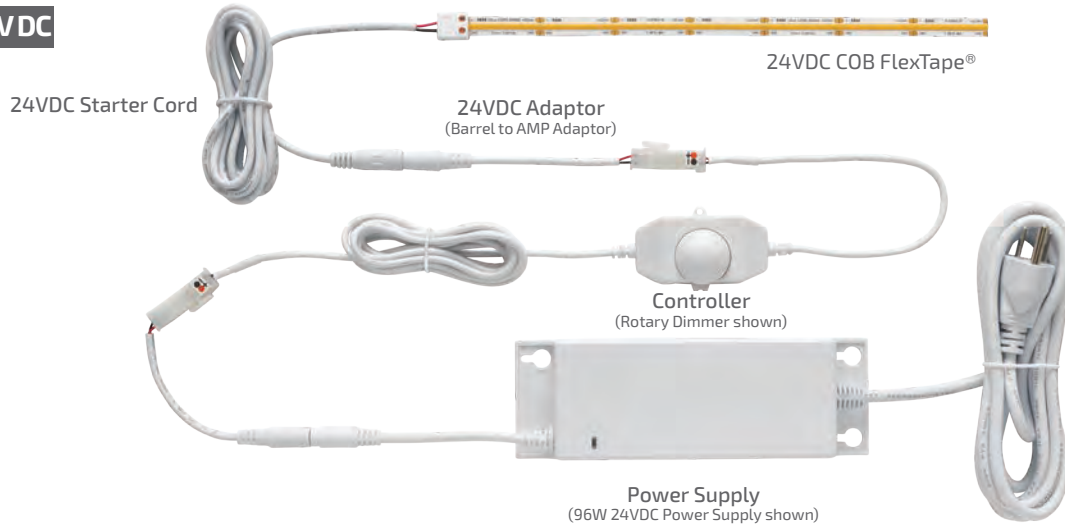





24VDC

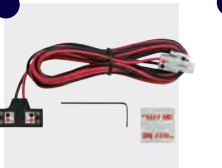

● Required
● Optional

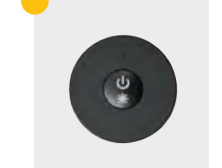
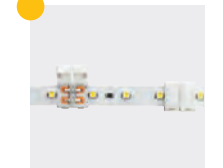
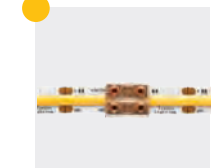
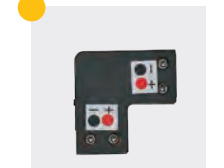
Accessories:

 <p>12VDC Power Supplies see power supply section</p>	 <p>24VDC Power Supplies see power supply section</p>	 <p>12VDC Starter Cord L-LED-TPEPKT-2M-1 L-TPEPKT-2IN-1</p>	 <p>24VDC Starter Cord L-24B25PKT-2M-1</p>	 <p>12VDC Tee Starter Cord L-LED-TPEPKT-2M-TEE-1</p>	 <p>24VDC Tee Starter Cord L-24B25PKT-2M-TEE-1</p>
 <p>Controllers see controller section</p>	 <p>12VDC Back-to-Back Connector L-TPELNK-BTB-1</p>	 <p>24VDC Back-to-Back Connector L-XSBTB-1</p>	 <p>Right Angle Connector L-LED-TPELNK-CON90-1</p>	 <p>Link Cord L-LED-TPELNK-5-1 L-LED-TPELNK-15-1 L-LED-TPELNK-25-1 L-LED-TPELNK-60-1 L-LED-TPELNK-120-1 L-LED-TPELNK-180-1</p>	

12VDC

FlexTape® 1.5W

1.5W/ft. (4.9W/m)	150 Lumens per ft. (492 per meter)	 115°
-----------------------------	---	--

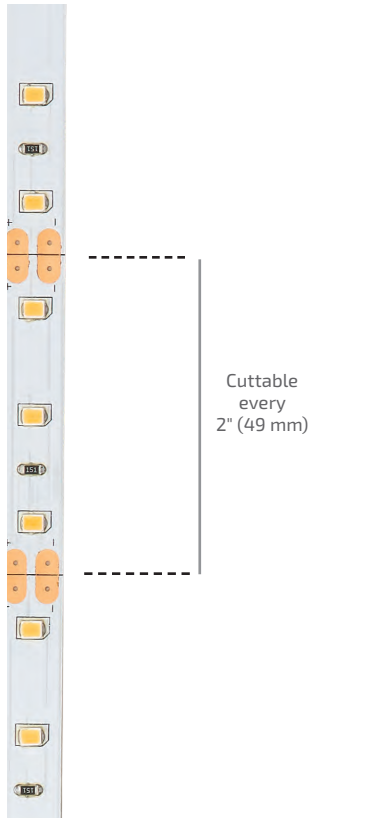

Dimensions:

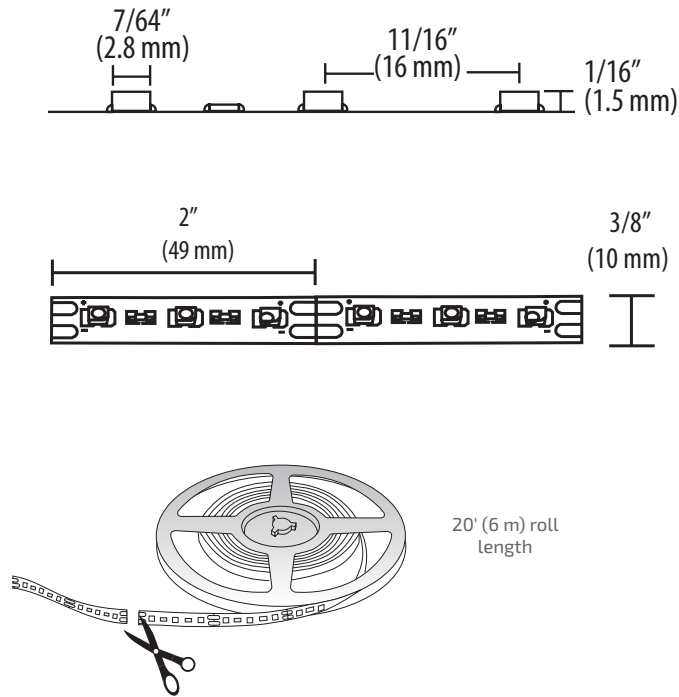

Specifications:

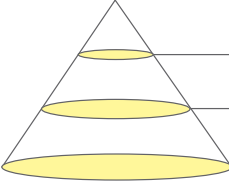

Wattage	Lumens	Efficacy (lm/W)	Input Voltage	Diode Life	Max Per 60W Power Supply	Max Continuous Run	Mounting	Warranty	Beam Angle
1.5W/ft. (4.9W/m)	150 per ft. (492 per m)	100	12VDC	50,000 Hours	40' (12 m)	20' (6 m)	Surface	5 Year	

Photometric Data				Color Temperature			
	Height	Light Output	Beam Area	Warm White	Warm to Neutral	Cool White	Daylight
	1ft (3m)	49.2Fc (529.6lx)	3.3ft L x 3.3ft W (1 m L x 1 m W)	2700K	3000K	4500K	6500K
	3ft (.9m)	5.47Fc (58.9lx)	9.8ft L x 10ft W (3 m L x 3 m W)	Warm (2700K)	Neutral (3500K)	Cool (4800K)	Daylight (6500K)
6ft (1.8m)	1.37Fc (14.7lx)	19.5ft L x 20ft W (5.9 m L x 6.1 m W)					

L-LED-FLXTPE-CROLL-1 Tested

● Red Available ● Blue Available

See page 86 for part numbers and descriptions

12VDC

FlexTape® 3W

3W/ft. (9.8W/m)	365 Lumens per ft. (1197 per meter)	 115°
---------------------------	--	--



Cutable every 1" (25 mm)



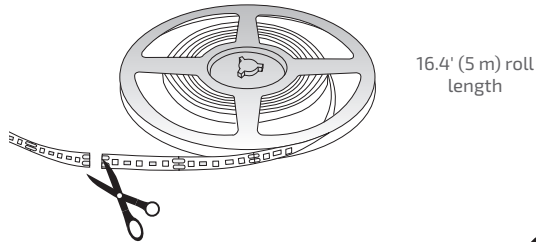
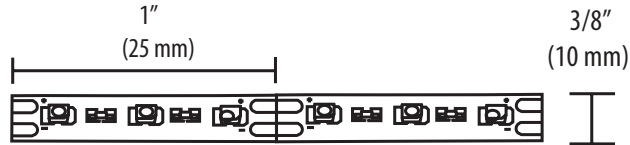
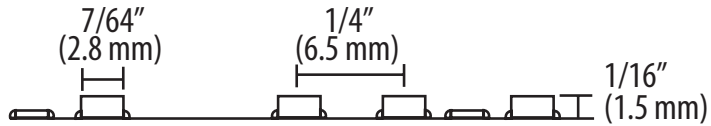

Dimensions:



Specifications:



Wattage	Lumens	Efficacy (lm/W)	Input Voltage	Diode Life	Max Per 60W Power Supply	Max Continuous Run	Mounting	Warranty	Beam Angle
3W/ft. (9.8W/m)	365 per ft. (1197 per m)	120	12VDC	50,000 Hours	20' (6 m)	16.4' (5 m)	Surface	5 Year	

Photometric Data				Color Temperature				
Height	Light Output	Beam Area	Warm White	Warm to Neutral	Cool White	Daylight		
1ft (.3 m)	120Fc (1219.7lx)	3.4ft L x 3.3ft W (1.1 m L x 1 m W)						
3ft (.9 m)	13.3Fc (143.2lx)	10.1ft L x 9.8ft W (3.1 m L x 3 m W)	2700K	3000K	3500K	4500K	5500K	6500K
6ft (1.8 m)	3.33Fc (35.8lx)	20.2ft L x 19.6ft W (6.2 m L x 6 m W)	Warm (2700K)	Warm (3000K)	Neutral (3500K)	Cool (4800K)		Daylight (6500K)
L-LED-FLXTPE-CRHO-1 Tested				● Red Available		● Blue Available		

See page 86 for part numbers and descriptions

FlexTape® 4.4W

12VDC

4.4W/ft. (14.4W/m)	420 Lumens per ft. (1378 per meter)	 115°
------------------------------	--	--



Cuttable every 2" (49 mm)

Dimensions:

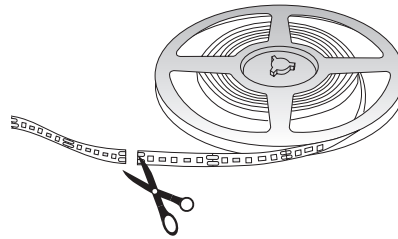
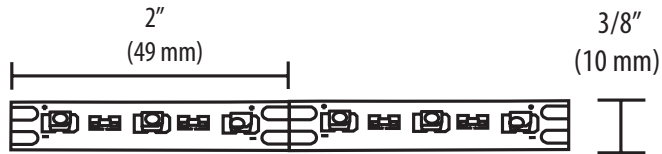
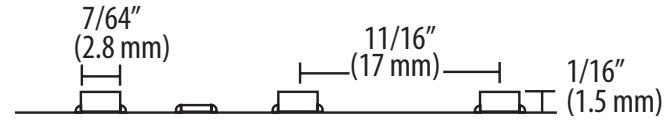



13' (3.96 m) roll length

Specifications:

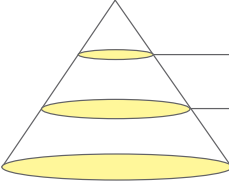

Wattage	Lumens	Efficacy (lm/W)	Input Voltage	Diode Life	Max Per 60W Power Supply	Max Continuous Run	Mounting	Warranty	Beam Angle
4.4W/ft. (14.4W/m)	420 per ft. (1378 per m)	95	12VDC	50,000 Hours	13' (3.96 m)	13' (3.96 m)	Surface	5 Year	

Photometric Data				Color Temperature				
	Height	Light Output	Beam Area					
	1ft (.3 m)	140Fc (1507lx)	3.2ft L x 3.3ft W (.98 m L x .91 m W)	2700K	3000K	4500K	5500K	6500K
	3ft (.9 m)	15.5Fc (166.8lx)	9.7ft L x 9.8ft W (3 m L x 3 m W)	Warm (2700K)	Warm (3000K)	Neutral (3500K)	Cool (4800K)	Daylight (6500K)
6ft (1.8 m)	3.88Fc (41.8lx)	19.4ft L x 19.7ft W (5.9 m L x 6 m W)						

L-FLXTPE-CRV-1 Tested

See page 86 for part numbers and descriptions

12VDC

FlexTape® 5.5W

5.5W/ft. (18W/m)	615 Lumens per ft. (2017 per meter)	 115°
----------------------------	--	--

Only to be used with Infinex



Cuttable every 1-1/2" (38 mm)

Dimensions:

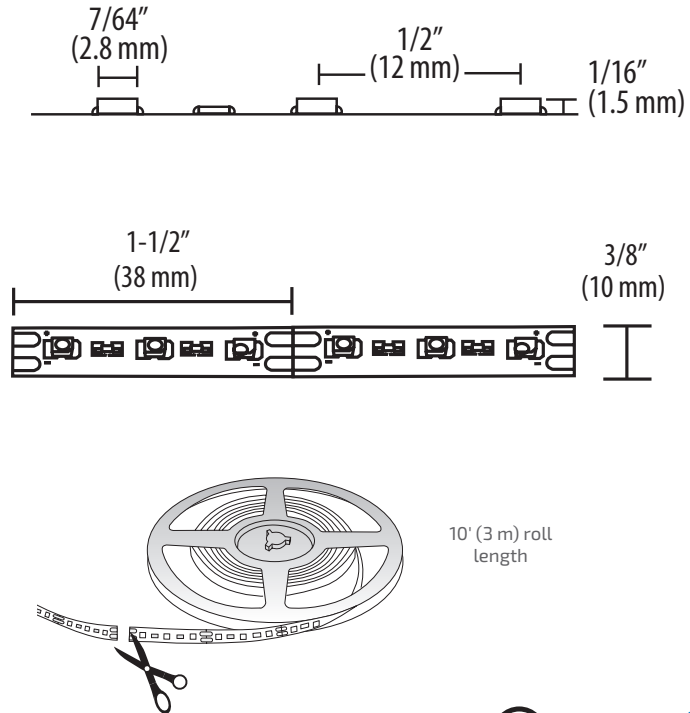

Specifications:



Wattage	Lumens	Efficacy (lm/W)	Input Voltage	Diode Life	Max Per 60W Power Supply	Max Continuous Run	Mounting	Warranty	Beam Angle
5.5W/ft. (18W/m)	615 per ft. (2017 per m)	112	12VDC	50,000 Hours	10' (3 m)	10' (3 m)	Surface	5 Year*	

Photometric Data

Height	Light Output	Beam Area
1ft (.3m)	205Fc (2207lx)	3.3ft L x 3.1ft W (1 m L x .94 m W)
3ft (.9m)	22.8Fc (245lx)	10ft L x 9.3ft W (3 m L x 2.8 m W)
6ft (1.8 m)	5.69Fc (61.3lx)	19.9ft L x 18.6ft W (6 m L x 5.6 m W)

L-FLXTPE-48RU-1 Tested

Color Temperature

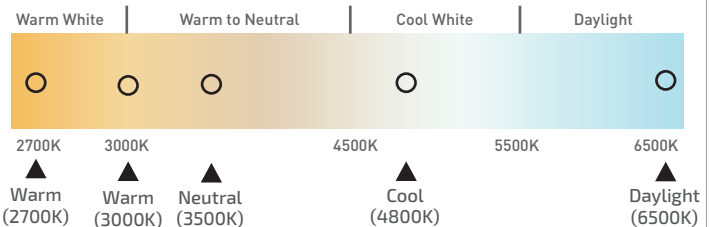

*MUST USE PROPER HEAT SINK (i.e. Infinex Aluminum Extrusions)

See page 86 for part numbers and descriptions

Edge Emitting FlexTape®

12VDC

2.5W/ft. (8.2W/m)	194 Lumens per ft. (636 per meter)	 110°
-----------------------------	---	---

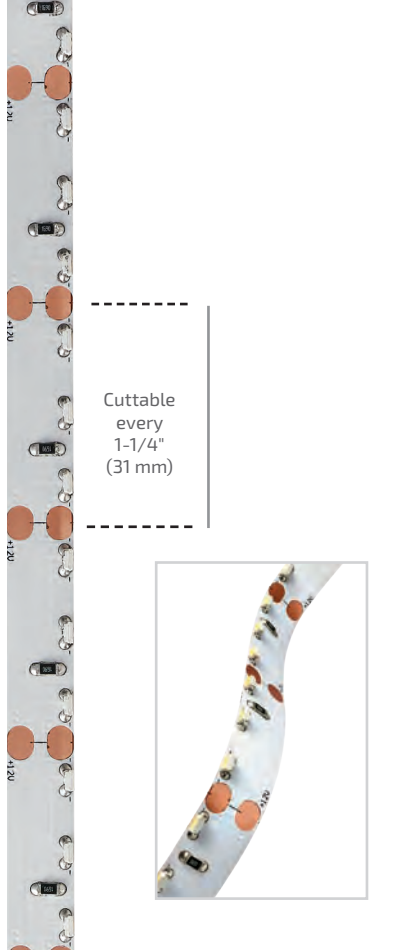

Dimensions:

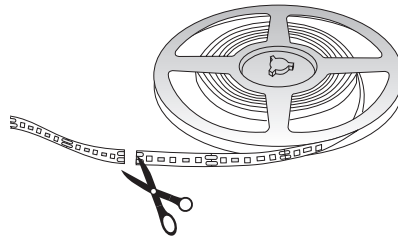
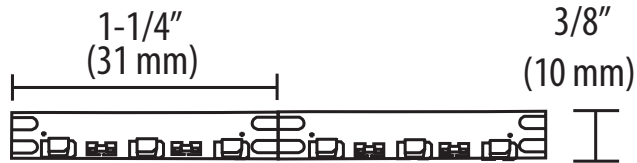
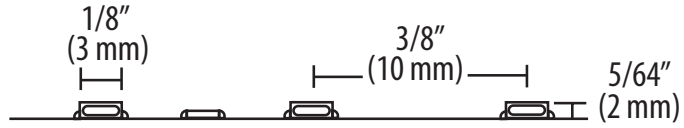



16.4' (5 m) roll length

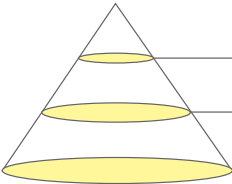

Specifications:

Wattage	Lumens	Efficacy (lm/W)	Input Voltage	Diode Life	Max Per 60W Power Supply	Max Continuous Run	Mounting	Warranty	Beam Angle
2.5W/ft. (8.2W/m)	194 per ft. (636 per m)	78	12VDC	50,000 Hours	24' (7.3 m)	16.4' (5 m)	Surface	5 Year	

Photometric Data				Color Temperature				
	Height	Light Output	Beam Area					
	1ft (.3 m)	80Fc (861.1lx)	3.1ft L x 2.8ft W (.94 m L x .85 m W)	2700K	3000K	4500K	5500K	6500K
	3ft (.9 m)	8.90Fc (9.7lx)	9.4ft L x 8.3ft W (2.9 m L x 2.5 m W)	▲ Warm (2700K)	▲ Neutral (3500K)	▲ Cool (4800K)	▲ Daylight (6500K)	
6ft (1.8 m)	2.22Fc (23.7lx)	18.9ft L x 16.7ft W (5.8 m L x 5.1 m W)						

L-FLXTPE-65EER-1 Tested

See page 87 for part numbers and descriptions

Economy Series

12VDC

EquiLine Tape LED 1.5W

1.5W/ft.
(4.9W/m)

135 Lumens per ft.
(443 per meter)



Cuttable every 2" (49 mm)

Dimensions:

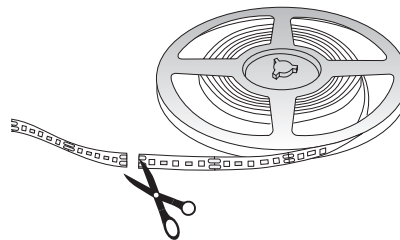
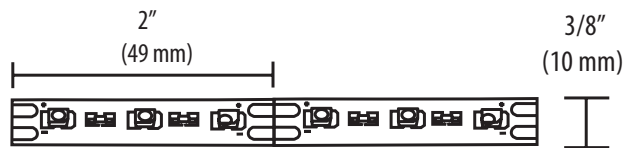
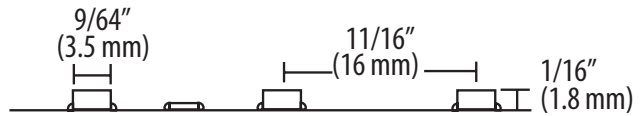

20' (6 m) roll length



Specifications:

Wattage	Lumens	Efficacy (lm/W)	Input Voltage	Diode Life	Max Per 60W Power Supply	Max Continuous Run	Mounting	Warranty	Beam Angle																	
1.5W/ft. (4.9W/m)	135 per ft. (443 per m)	90	12VDC	25,000 Hours	40' (12 m)	20' (6 m)	Surface	2 Year	115°																	
Photometric Data					Color Temperature																					
	Height	Light Output	Beam Area	<table border="1"> <tr> <th>Warm White</th> <th colspan="2">Warm to Neutral</th> <th>Cool White</th> <th colspan="2">Daylight</th> </tr> <tr> <td>2700K</td> <td>3000K</td> <td>3500K</td> <td>4500K</td> <td>5500K</td> <td>6500K</td> </tr> <tr> <td>Warm (2700K)</td> <td>Warm (3000K)</td> <td>Neutral (3500K)</td> <td>Cool (4800K)</td> <td colspan="2">Daylight (6500K)</td> </tr> </table>					Warm White	Warm to Neutral		Cool White	Daylight		2700K	3000K	3500K	4500K	5500K	6500K	Warm (2700K)	Warm (3000K)	Neutral (3500K)	Cool (4800K)	Daylight (6500K)	
	Warm White	Warm to Neutral		Cool White	Daylight																					
	2700K	3000K	3500K	4500K	5500K	6500K																				
	Warm (2700K)	Warm (3000K)	Neutral (3500K)	Cool (4800K)	Daylight (6500K)																					
1ft (0.3 m)	44.1Fc (474.6lx)	3.1ft L x 3.3ft W (0.9 m L x 1.1 m W)																								
3ft (0.9 m)	4.9Fc (52.7lx)	9.4ft L x 9.8ft W (2.9 m L x 3 m W)																								
6ft (1.8 m)	1.23Fc (13.3lx)	18.8ft L x 19.6ft W (5.7 m L x 6 m W)																								

L-TPELED-48SER-1 Tested

See page 87 for part numbers and descriptions

EquiLine Tape LED

Economy Series

EquiLine Tape LED 3W

12VDC

3W/ft.
(9.8W/m)

255 Lumens per ft.
(836 per meter)



Cutable every 1" (25 mm)

Dimensions:

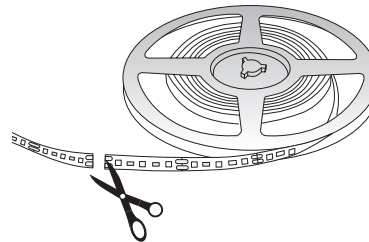
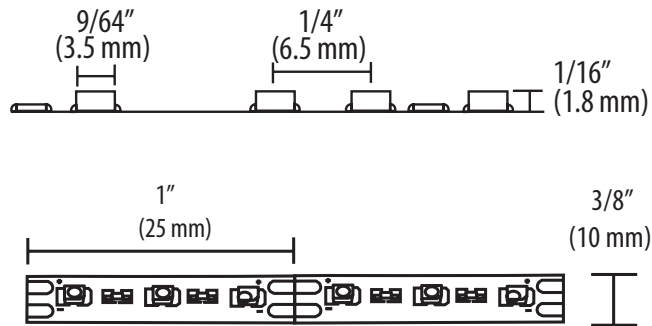

16.4' (5 m) roll length



Specifications:

Wattage	Lumens	Efficacy (lm/W)	Input Voltage	Diode Life	Max Per 60W Power Supply	Max Continuous Run	Mounting	Warranty	Beam Angle
3W/ft. (9.8W/m)	255 per ft. (836 per m)	85	12VDC	25,000 Hours	20' (6 m)	16.4' (5 m)	Surface	2 Year	115°

Photometric Data

Height	Light Output	Beam Area
1ft (.3 m)	83.9Fc (903.1lx)	3.2ft L x 3.3ft W (1 m L x 1 m W)
3ft (.9 m)	9.32Fc (100.3lx)	9.5ft L x 9.9ft W (2.9 m L x 3 m W)
6ft (1.8 m)	2.33Fc (25.1lx)	19.1ft L x 19.9ft W (5.8 m L x 6.1 m W)

L-TPELED-48HER-1 Tested

Color Temperature

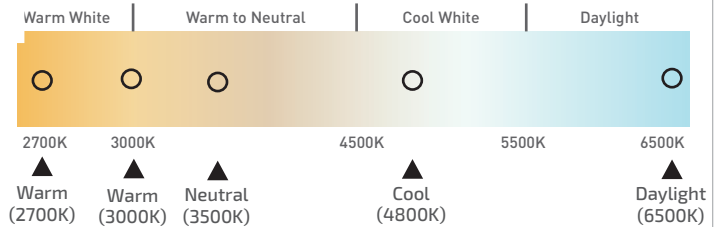

See page 87 for part numbers and descriptions

Economy Series
EquiLine Tape LED 4.4W

12VDC

4.4W/ft. (14.4W/m)	395 Lumens per ft. (1296 per meter)	115°
------------------------------	---	-------------



Cuttable every 1" (25 mm)

Dimensions:

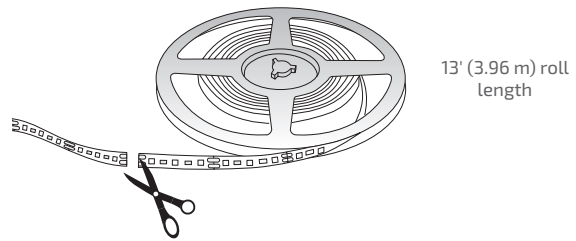
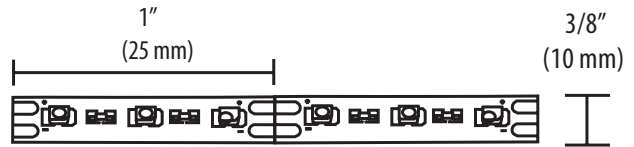
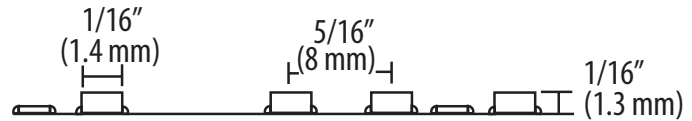

13' (3.96 m) roll length



Specifications:

Wattage	Lumens	Efficacy (lm/W)	Input Voltage	Diode Life	Max Per 60W Power Supply	Max Continuous Run	Mounting	Warranty	Beam Angle
4.4W/ft. (14.4W/m)	395 per ft. (1296 per m)	89	12VDC	25,000 Hours	13' (3.96 m)	13' (3.96 m)	Surface	2 Year	115°

Photometric Data				Color Temperature			
	Height	Light Output	Beam Area	Warm White	Warm to Neutral	Cool White	Daylight
	1ft (0.3m)	135Fc (1453lx)	3.4ft L x 3.3ft W (1 m L x 1 m W)	2700K	3000K	4500K	6500K
	3ft (0.9m)	14.9Fc (160.4lx)	10.1ft L x 10ft W (3.1 m L x 3 m W)	Warm (2700K)	Warm (3000K)	Neutral (3500K)	Cool (4800K)
6ft (1.8m)	3.74Fc (40.3lx)	20.2ft L x 20.0ft W (6.2 m L x 6.1 m W)					

L-TPELED-48VER-1 Tested

See page 87 for part numbers and descriptions

NEW!

COB FlexTape®

12VDC

4.4W/ft.
(14.5W/m)

245 Lumens
per ft.
(809 per meter)



Chip on Board or "COB" LED tape is the latest advancement in tape lighting. With diodes directly mounted on a printed circuit board and a continuous fortified coating, this flexible, high density LED lighting strip creates our Luniform look without dark spots – no covers or filters needed!

Features:

New generation of tape lighting

115° beam angle

Available in 2700K, 3000K, 3500K, 4800K or 6500K

Wattage: 4.4W/ft. – 13' (4 m) roll

Cuttable every 11/16" (18 mm)

High-density lighting

Can be used with Inflex extrusions (sold separately)

Indoor use only

Typical Applications:

Store fixtures

Edge lighting

Backlighting

Accent lighting

Cove lighting

Toe kick

Soffit



Dimensions:

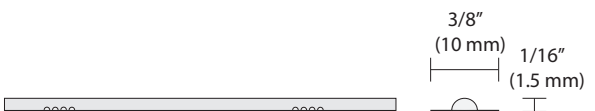
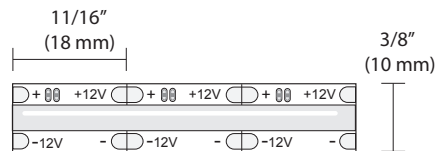

Cuttable every
11/16"
(18 mm)

Encapsulated diodes are protected from splashes, dust and moisture.



Sold by the roll



Strong 300 LSE 3M™ adhesive backing

Typical Setup:

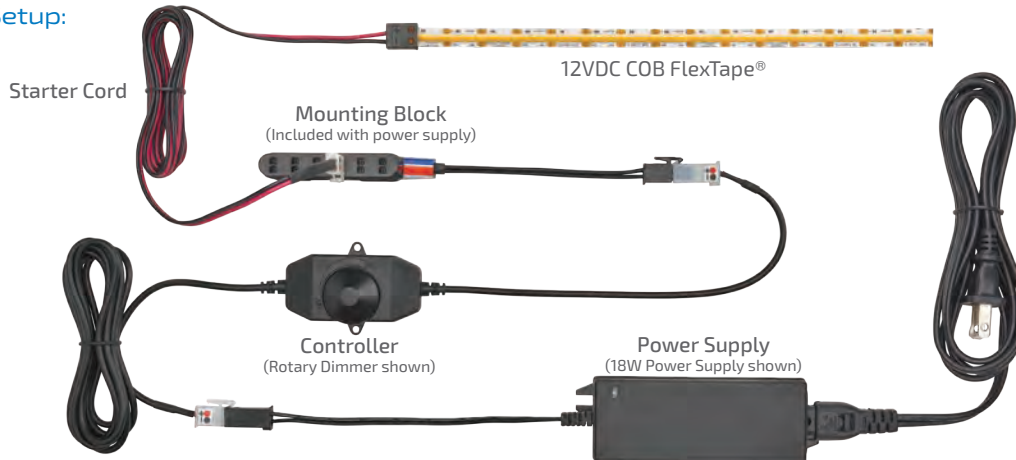

- Required
- Optional

Accessories:

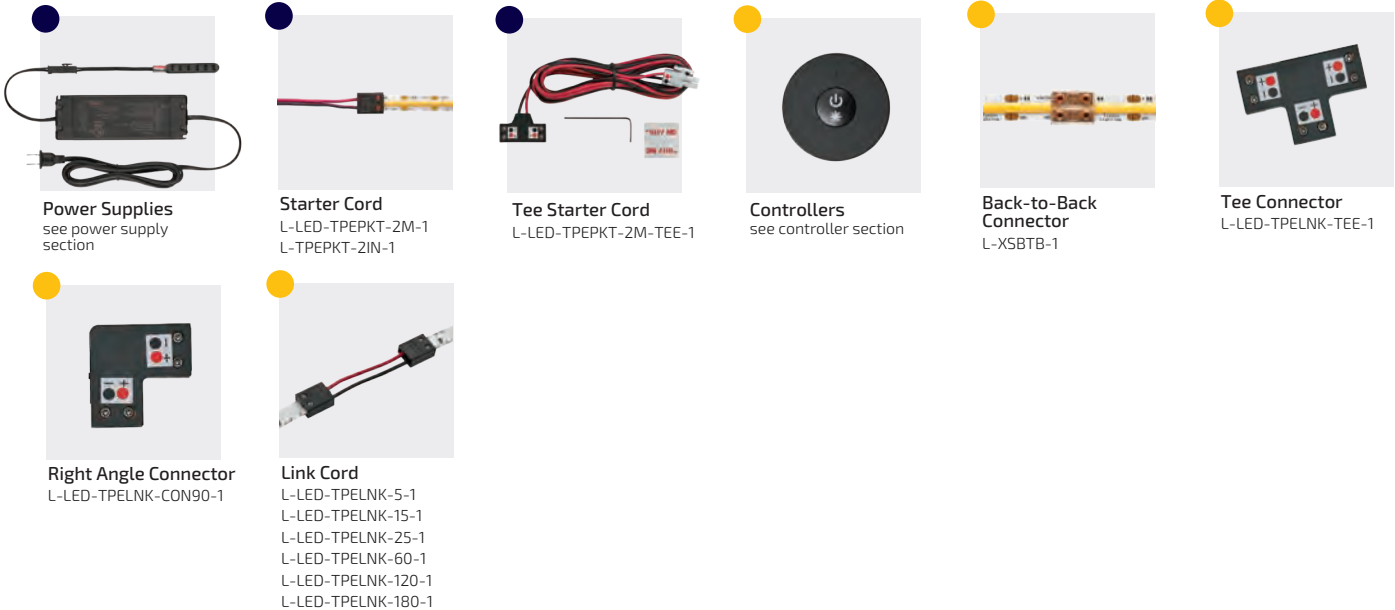

Specifications:

Wattage	Lumens	Efficacy (lm/W)	Input Voltage	Diode Life	Max Per Power Supply 60W (12VDC)	Max Continuous Run	Mounting	Warranty	Beam Angle															
4.4W/ft. (14.5W/m)	245 per ft. (809 per m)	55.7	12VDC	50,000 Hours	13' (4 m)	13' (4 m)	Surface	5 year																
Photometric Data					Color Temperature																			
		Height	Light Output	Beam Area	<table border="1"> <tr> <td>Warm White</td> <td colspan="2">Warm to Neutral</td> <td>Cool White</td> <td>Daylight</td> </tr> <tr> <td>2700K</td> <td>3000K</td> <td>3500K</td> <td>4500K</td> <td>5500K 6500K</td> </tr> <tr> <td>▲ Warm (2700K)</td> <td>▲ Warm (3000K)</td> <td>▲ Neutral (3500K)</td> <td>▲ Cool (4800K)</td> <td>▲ Daylight (6500K)</td> </tr> </table>					Warm White	Warm to Neutral		Cool White	Daylight	2700K	3000K	3500K	4500K	5500K 6500K	▲ Warm (2700K)	▲ Warm (3000K)	▲ Neutral (3500K)	▲ Cool (4800K)	▲ Daylight (6500K)
Warm White	Warm to Neutral		Cool White	Daylight																				
2700K	3000K	3500K	4500K	5500K 6500K																				
▲ Warm (2700K)	▲ Warm (3000K)	▲ Neutral (3500K)	▲ Cool (4800K)	▲ Daylight (6500K)																				
	1ft (.3 m)	74.7Fc (804lx)	3.1ft L x 10.9ft W (94 m L x 3.3 m W)																					
	3ft (.9 m)	8.3Fc (89.3lx)	9.3ft L x 32.6ft W (2.8 m L x 9.9 m W)																					
	6ft (1.8 m)	2.07Fc (22.3lx)	18.6ft L x 65.2ft W (5.7 m L x 19.9 m W)																					
L-FLXCOB12-48RV-1 Tested																								

See page 88 for part numbers and descriptions

NEW!

COB FlexTape®

24VDC

5.5W/ft.
(18.1W/m)

420 Lumens
per ft.
(1386 per meter)



Chip on Board or "COB" LED tape is the latest advancement in tape lighting. With diodes directly mounted on a printed circuit board and a continuous fortified coating, this flexible, high density LED lighting strip creates our Luniform look without dark spots – no covers or filters needed!

Features:

New generation of tape lighting

115° beam angle

Available in 2700K, 3000K, 3500K, 4800K or 6500K

Wattage: 5.5W/ft. – 16.4' (5 m) roll

Cuttable every 1-1/2" (38 mm)

High-density lighting

Can be used with Inflex extrusions (sold separately)

Indoor use only

Typical Applications:

Store fixtures

Edge lighting

Backlighting

Accent lighting

Cove lighting

Toe kick

Soffit



Dimensions:

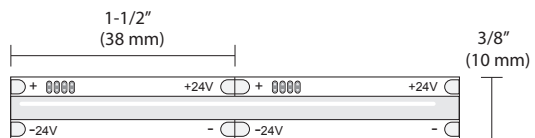

Encapsulated diodes are protected from splashes, dust and moisture.



Sold by the roll



Strong 300 LSE 3M™ adhesive backing



Cuttable every
1-1/2" (38 mm)

Typical Setup:

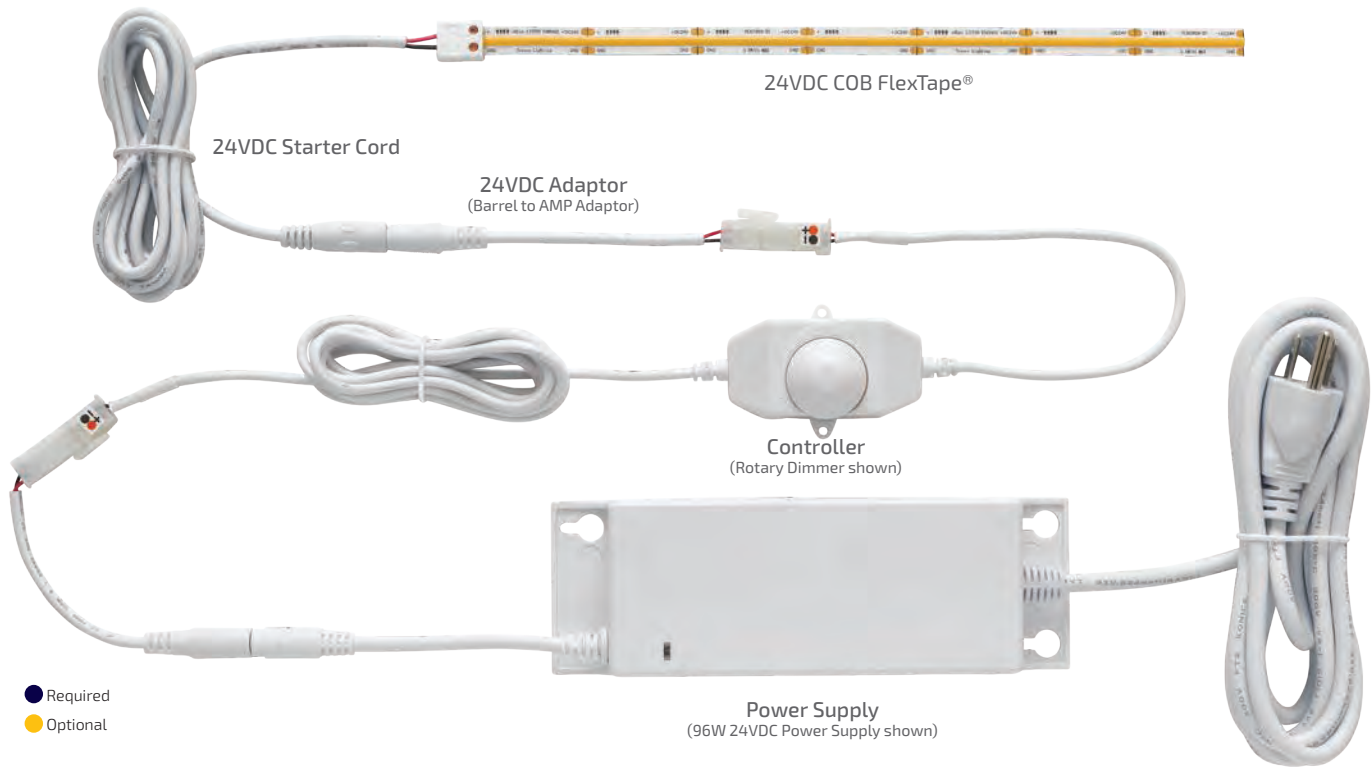

- Required
- Optional

Accessories:

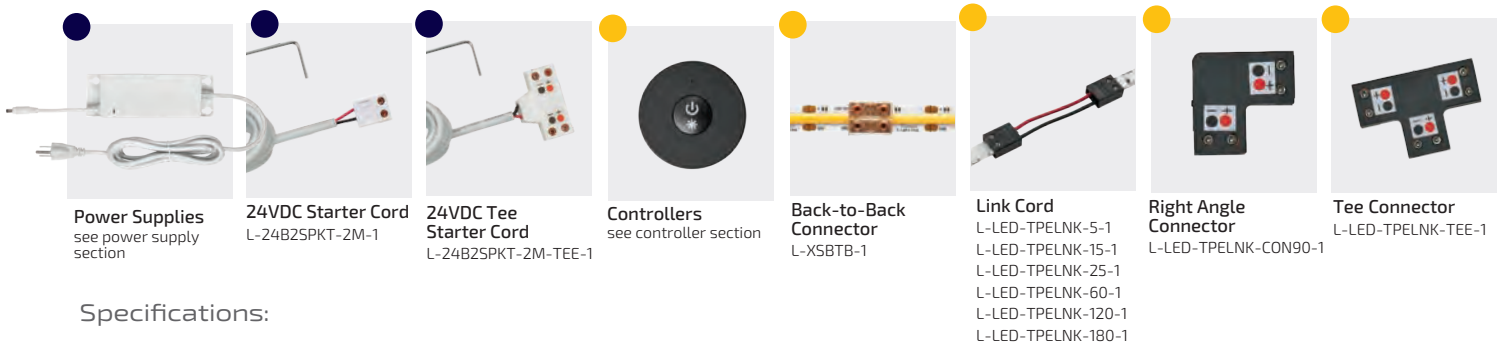

Specifications:

Wattage	Lumens	Efficacy (lm/W)	Input Voltage	Diode Life	Max Per Power Supply 96W	Max Continuous Run	Mounting	Warranty	Beam Angle																				
5.5W/ft. (18.1W/m)	420 per ft (1386 per m)	76.4	24VDC	50,000 Hours	16.4' (5 m)	16.4' (5 m)	Surface	5 year																					
Photometric Data					Color Temperature																								
	Height	Light Output	Beam Area																										
	1ft (.3 m)	123Fc (1324lx)	3.1ft L x 8.5ft W (94 m L x 2.6 m W)																										
	3ft (.9 m)	13.6Fc (146.3lx)	9.3ft L x 32.6ft W (2.9 m L x 7.8 m W)																										
	6ft (1.8 m)	3.41Fc (36.7lx)	18.7ft L x 51.2ft W (5.7 m L x 15.6 m W)																										
L-FLXCOB24-48RU-1 Tested				<table border="1"> <tr> <th>Warm White</th> <th colspan="2">Warm to Neutral</th> <th>Cool White</th> <th>Daylight</th> </tr> <tr> <td></td> <td></td> <td></td> <td></td> <td></td> </tr> <tr> <td>2700K</td> <td>3000K</td> <td>3500K</td> <td>4500K</td> <td>6500K</td> </tr> <tr> <td>▲ Warm (2700K)</td> <td>▲ Warm (3000K)</td> <td>▲ Neutral (3500K)</td> <td>▲ Cool (4800K)</td> <td>▲ Daylight (6500K)</td> </tr> </table>						Warm White	Warm to Neutral		Cool White	Daylight						2700K	3000K	3500K	4500K	6500K	▲ Warm (2700K)	▲ Warm (3000K)	▲ Neutral (3500K)	▲ Cool (4800K)	▲ Daylight (6500K)
Warm White	Warm to Neutral		Cool White	Daylight																									
2700K	3000K	3500K	4500K	6500K																									
▲ Warm (2700K)	▲ Warm (3000K)	▲ Neutral (3500K)	▲ Cool (4800K)	▲ Daylight (6500K)																									

See page 90 for part numbers and descriptions

Single Color Tape

All product dimensions and specifications are subject to change without prior notice.

- Required
- Optional

● 12VDC FlexTape® 1.5W

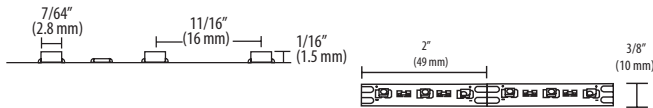
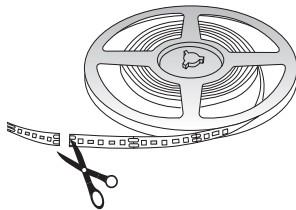

Part #	Description
L-LED-FLXTPE-WROLL-1	20' (6 m) 12VDC 2700K FlexTape® Roll
L-FLXTPE-30RS-1	20' (6 m) 12VDC 3000K FlexTape® Roll
L-LED-FLXTPE-NROLL-1	20' (6 m) 12VDC 3500K FlexTape® Roll
L-LED-FLXTPE-CROLL-1	20' (6 m) 12VDC 4800K FlexTape® Roll
L-LED-FLXTPE-DROLL-1	20' (6 m) 12VDC 6500K FlexTape® Roll
L-LED-FLXTPE-BROLL-1	20' (6 m) 12VDC Blue FlexTape® Roll
L-LED-FLXTPE-RROLL-1	20' (6 m) 12VDC Red FlexTape® Roll

Maximum continuous run is 20' (6 m). Maximum per power supply is 40' (12 m). Mounts with adhesive backing. Cuttable every 2" (49 mm). To be used on clean, smooth surfaces. Pressure must be applied for proper 3M™ tape adhesion.

● 12VDC FlexTape® 3W

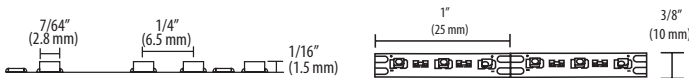
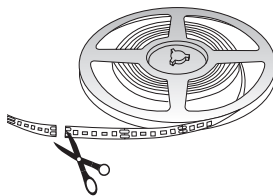

Part #	Description
L-LED-FLXTPE-WRHO-1	16.4' (5 m) 12VDC 2700K High Output FlexTape® Roll
L-FLXTPE-30RH-1	16.4' (5 m) 12VDC 3000K High Output FlexTape® Roll
L-LED-FLXTPE-NRHO-1	16.4' (5 m) 12VDC 3500K High Output FlexTape® Roll
L-LED-FLXTPE-CRHO-1	16.4' (5 m) 12VDC 4800K High Output FlexTape® Roll
L-LED-FLXTPE-DRHO-1	16.4' (5 m) 12VDC 6500K High Output FlexTape® Roll
L-LED-FLXTPE-RRHO-1	16.4' (5 m) 12VDC Red High Output FlexTape® Roll
L-LED-FLXTPE-BRHO-1	16.4' (5 m) 12VDC Blue High Output FlexTape® Roll

Maximum continuous run is 16.4' (5 m). Maximum per power supply is 20' (6 m). Mounts with adhesive backing. Cuttable every 1" (25 mm). To be used on clean, smooth surfaces. Pressure must be applied for proper 3M™ tape adhesion.

● 12VDC FlexTape® 4.4W

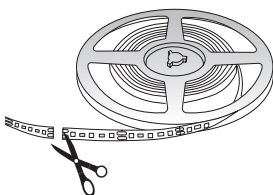

Part #	Description
L-FLXTPE-WRV-1	13' (4 m) 12VDC 2700K High Output FlexTape® Roll
L-FLXTPE-30RV-1	13' (4 m) 12VDC 3000K High Output FlexTape® Roll
L-FLXTPE-NRV-1	13' (4 m) 12VDC 3500K High Output FlexTape® Roll
L-FLXTPE-CRV-1	13' (4 m) 12VDC 4800K High Output FlexTape® Roll
L-FLXTPE-DRV-1	13' (4 m) 12VDC 6500K High Output FlexTape® Roll

Maximum continuous run is 13' (4 m). Maximum per power supply is 13' (4 m). Mounts with adhesive backing. Cuttable every 2" (49 mm). To be used on clean, smooth surfaces. Pressure must be applied for proper 3M™ tape adhesion.

● 12VDC FlexTape® 5.5W

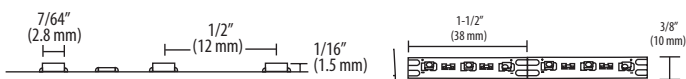
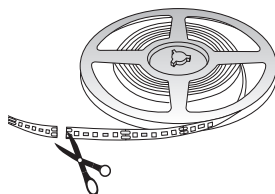

Part #	Description
L-FLXTPE-27RU-1	10' (3 m) 12VDC 2700K Ultra Output FlexTape® Roll
L-FLXTPE-30RU-1	10' (3 m) 12VDC 3000K Ultra Output FlexTape® Roll
L-FLXTPE-35RU-1	10' (3 m) 12VDC 3500K Ultra Output FlexTape® Roll
L-FLXTPE-48RU-1	10' (3 m) 12VDC 4800K Ultra Output FlexTape® Roll
L-FLXTPE-65RU-1	10' (3 m) 12VDC 6500K Ultra Output FlexTape® Roll

Maximum continuous run is 10' (3 m). Maximum per power supply is 10' (3 m). Mounts with adhesive backing. Cuttable every 1-1/2" (38 mm). To be used on clean, smooth surfaces. Pressure must be applied for proper 3M™ tape adhesion. **MUST USE PROPER HEAT SINK (i.e. Infinex Aluminum Extrusions)**

Single Color Tape

All product dimensions and specifications are subject to change without prior notice.

- Required
- Optional

● 12VDC Edge Emitting FlexTape®

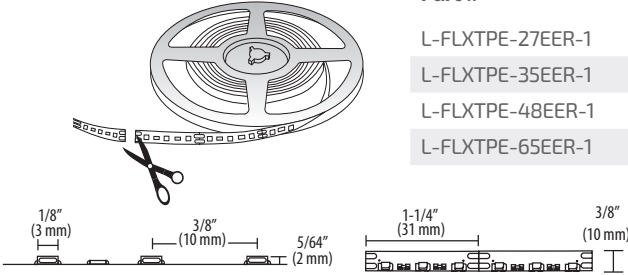

Part

L-FLXTPE-27EER-1	16.4' (5 m) 12VDC 2700K Edge Emitting FlexTape® LED Roll
L-FLXTPE-35EER-1	16.4' (5 m) 12VDC 3500K Edge Emitting FlexTape® LED Roll
L-FLXTPE-48EER-1	16.4' (5 m) 12VDC 4800K Edge Emitting FlexTape® LED Roll
L-FLXTPE-65EER-1	16.4' (5 m) 12VDC 6500K Edge Emitting FlexTape® LED Roll

Description

Maximum continuous run is 16.4' (5 m). Maximum per power supply is 24' (7 m). Mounts with adhesive backing. Cuttable every 1-1/4" (31 mm). To be used on clean, smooth surfaces. Pressure must be applied for proper 3M™ tape adhesion.

● 12VDC Equiline Tape LED 1.5W

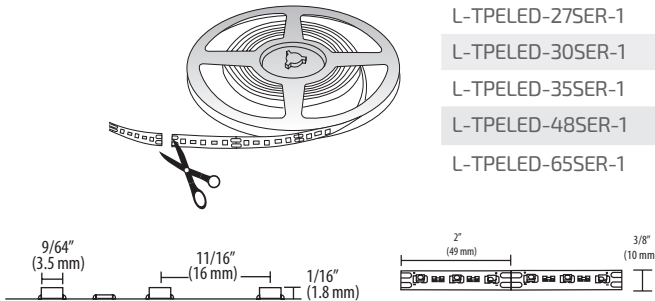

Part

L-TPELED-27SER-1	Equiline 20' (6 m) Roll Tape LED 2700K
L-TPELED-30SER-1	Equiline 20' (6 m) Roll Tape LED 3000K
L-TPELED-35SER-1	Equiline 20' (6 m) Roll Tape LED 3500K
L-TPELED-48SER-1	Equiline 20' (6 m) Roll Tape LED 4800K
L-TPELED-65SER-1	Equiline 20' (6 m) Roll Tape LED 6500K

Description

Maximum continuous run is 20' (6 m). Maximum per power supply is 40' (12 m). Mounts with adhesive backing. Cuttable every 2" (49 mm). To be used on clean, smooth surfaces. Pressure must be applied for proper 3M™ tape adhesion.

● 12VDC Equiline Tape LED 3W

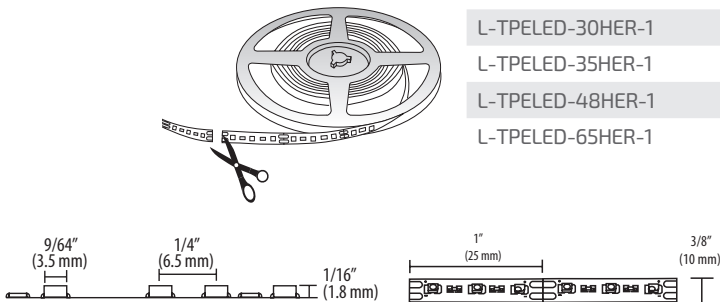

Part

L-TPELED-27HER-1	Equiline 16.4' (5 m) Roll Tape LED 2700K
L-TPELED-30HER-1	Equiline 16.4' (5 m) Roll Tape LED 3000K
L-TPELED-35HER-1	Equiline 16.4' (5 m) Roll Tape LED 3500K
L-TPELED-48HER-1	Equiline 16.4' (5 m) Roll Tape LED 4800K
L-TPELED-65HER-1	Equiline 16.4' (5 m) Roll Tape LED 6500K

Description

Maximum continuous run is 16.4' (5 m). Maximum per power supply is 20' (6 m). Mounts with adhesive backing. Cuttable every 1" (25 mm). To be used on clean, smooth surfaces. Pressure must be applied for proper 3M™ tape adhesion.

● 12VDC Equiline Tape LED 4.4W

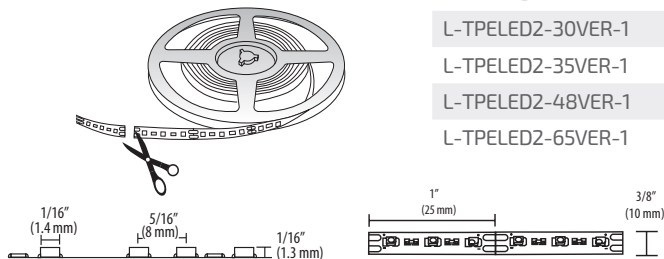

Part

L-TPELED2-27VER-1	Equiline 13' (3.96 m) Roll Tape LED 2700K
L-TPELED2-30VER-1	Equiline 13' (3.96 m) Roll Tape LED 3000K
L-TPELED2-35VER-1	Equiline 13' (3.96 m) Roll Tape LED 3500K
L-TPELED2-48VER-1	Equiline 13' (3.96 m) Roll Tape LED 4800K
L-TPELED2-65VER-1	Equiline 13' (3.96 m) Roll Tape LED 6500K

Description

Maximum continuous run is 13' (3.96 m). Maximum per power supply is 13' (3.96 m). Mounts with adhesive backing. Cuttable every 1" (25 mm). To be used on clean, smooth surfaces. Pressure must be applied for proper 3M™ tape adhesion.

Single Color Tape

- Required
- Optional

● 12VDC COB FlexTape® 4.4W

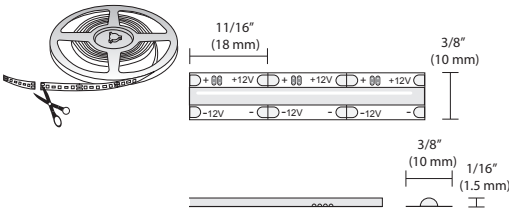

Part #	Description
L-FLXCOB12-27RV-1	12VDC 4.4W/FT 2700K COB FlexTape® 13' (4 m) Roll
L-FLXCOB12-30RV-1	12VDC 4.4W/FT 3000K COB FlexTape® 13' (4 m) Roll
L-FLXCOB12-35RV-1	12VDC 4.4W/FT 3500K COB FlexTape® 13' (4 m) Roll
L-FLXCOB12-48RV-1	12VDC 4.4W/FT 4800K COB FlexTape® 13' (4 m) Roll
L-FLXCOB12-65RV-1	12VDC 4.4W/FT 6500K COB FlexTape® 13' (4 m) Roll

Maximum continuous run is 13' (4 m). Maximum per power supply is 13' (4 m). Mounts with adhesive backing. Cuttable every 11/16" (18 mm) . To be used on clean, smooth surfaces. Pressure must be applied for proper 3M™ tape adhesion.

● 12VDC Power Supplies



Part #	Description
L-DC-ELT18-CON-1	18W 12VDC Power Supply w/6 Snap Mounting Block*
L-DC-SLELT30-1	30W 12VDC Power Supply w/6 Snap Mounting Block*
L-DC-SLELT60-1	60W 12VDC Power Supply w/6 Snap Mounting Block*
L-DC-ELT6WP-CON-1	6W 12VDC Wall Mount Power Supply w/3 Snap Block*
L-DC-ELT15WP-CON-1	15W 12VDC Wall Mount Power Supply w/6 Snap Block*
L-DC-EQ30-1	30W 12VDC Equiline Power Supply w/6 Snap Block*
L-DC-EQ60-1	60W 12VDC Equiline Power Supply w/6 Snap Block*
L-DCE30D-CON-1	30W 12VDC Hardwire Dimmable LED Power Supply†
L-DCE60D-CON-1	60W 12VDC Hardwire Dimmable LED Power Supply†
L-12DCH60X1-1	60W 12VDC Commercial/Industrial Metal Hardwire Dimmable Power Supply§
L-12DCH60X3-1	180W 12VDC Commercial/Industrial Metal Hardwire Dimmable Power Supply§

* Dimmable on trailing edge (12VDC side). Mounting block and power cord are included.

† Dimmable by LED line voltage (120V) wall dimmers. Mounting block included.

§ Dimmable by LED line voltage (120V) wall dimmers. Mounting block not included

All hardwire power supplies require an electrician for install.

● 12VDC Starter Cord for Single Color Tape

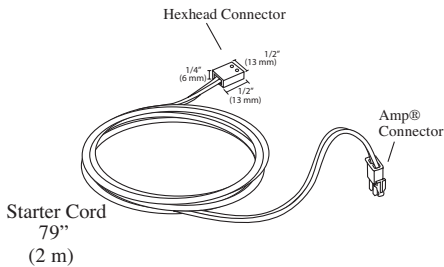

Part #	Description
L-LED-TPEPKT-2M-1	2 m (79") FlexTape® Straight Starter Lead
L-TPEPKT-2IN-1	50 mm (2") FlexTape® Straight Starter Lead

● 12VDC Tee Starter Cord for Single Color Tape

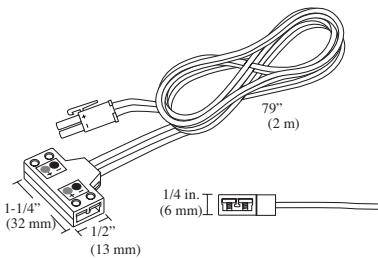

Part #	Description
L-LED-TPEPKT-2M-TEE-1	2 m (79") FlexTape® Tee Starter Lead

● **12/24VDC Tee Connector for Single Color Tape**

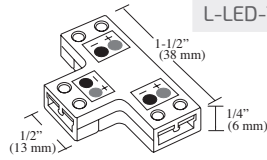

Part #	Description
L-LED-TPELNK-TEE-1	Tee Link Connector

● **12/24VDC Right Angle Connector for Single Color Tape**

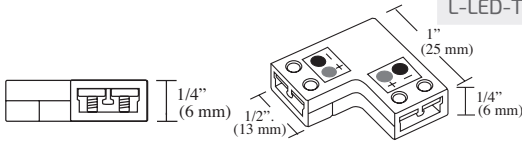

Part #	Description
L-LED-TPELNK-CON90-1	90° Link Connector

● **12/24VDC Link Cord for Single Color Tape**



Positive and negative contacts on FlexTape® and FlexConnects should match-up to maintain proper polarity.

Part #	Description
L-LED-TPELNK-5-1	5 cm (2") FlexTape® Link Cord
L-LED-TPELNK-15-1	15 cm (6") FlexTape® Link Cord
L-LED-TPELNK-25-1	25 cm (10") FlexTape® Link Cord
L-LED-TPELNK-60-1	60 cm (24") FlexTape® Link Cord
L-LED-TPELNK-120-1	120 cm (48") FlexTape® Link Cord
L-LED-TPELNK-180-1	180 cm (72") FlexTape® Link Cord

● **12VDC Back-to-Back Connector for Single Color FlexTape®**

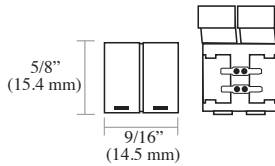

Part #	Description
L-TPELNK-BTB-1	Back-to-Back Connector

To be used with non-COB single color tapes.

● **12/24VDC Back-to-Back Connector for COB**

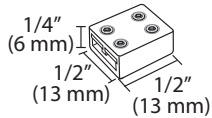

Part #	Description
L-XSBTB-1	10 mm, 2 Position Back-to-Back Connector, Clear



COMPONENTS: POWER SUPPLIES, CONTROLLERS AND MORE SEE PAGE 141.

Single Color Tape

All product dimensions and specifications are subject to change without prior notice.

- Required
- Optional

● 24VDC COB FlexTape® 5.5W

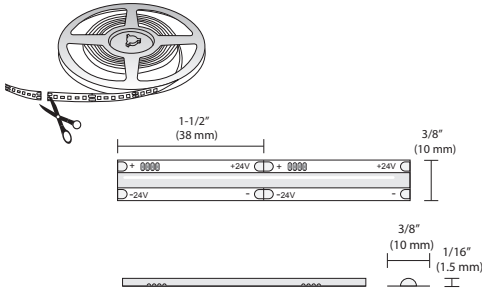

Part #	Description
L-FLXCOB24-27RU-1	24VDC 5.5W/FT 2700K COB FlexTape® 16.4' (5 m) Roll
L-FLXCOB24-30RU-1	24VDC 5.5W/FT 3000K COB FlexTape® 16.4' (5 m) Roll
L-FLXCOB24-35RU-1	24VDC 5.5W/FT 3500K COB FlexTape® 16.4' (5 m) Roll
L-FLXCOB24-48RU-1	24VDC 5.5W/FT 4800K COB FlexTape® 16.4' (5 m) Roll
L-FLXCOB24-65RU-1	24VDC 5.5W/FT 6500K COB FlexTape® 16.4' (5 m) Roll

Maximum continuous run is 16.4' (5 m). Maximum per power supply is 16.4' (5 m). Mounts with adhesive backing. Cuttable every 1-1/2" (38 mm). To be used on clean, smooth surfaces. Pressure must be applied for proper 3M™ tape adhesion.

● 24VDC Power Supplies



Part #	Description
L-24DCELT96-1	96W 24VDC Power Supply w/ 5 Barrel Out - White†
L-24DCELT48-BL-1	48W 24VDC Power Supply w/ 5 Barrel Out - Black†
L-24DCELT15WP-1	15W 24VDC Wall Mount Power Supply w/ Snap Connector*†
L-24DCH96X1-1	96W 24VDC Dimmable Hardwire Power Supply*§
L-24DCH96X3-1	288W 24VDC Dimmable Hardwire Power Supply*§
L-1BRL5-1	Extra 5 Output Barrel Splice

*Does not come with 5 Output Barrel Splice
 †Dimmable on trailing edge (24VDC side)
 §Dimmable by LED line voltage (120V) wall dimmers

● 24VDC Starter Cord for COB

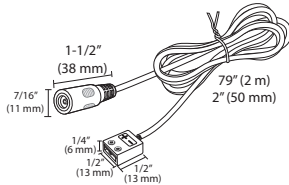

Part #	Description
L-24B2SPKT-2M-1	2 m (79") 24VDC FlexTape® Barrel/2 Screw Trml Starter Lead, White

● 24VDC Tee Starter Cord for COB

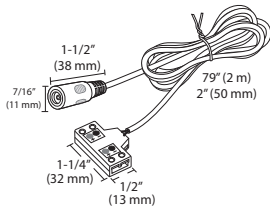

Part #	Description
L-24B2SPKT-2M-TEE-1	2 m (79") 24VDC FlexTape® Barrel/2 Screw Trml Tee Starter Lead, White

● 24VDC Extension Lead

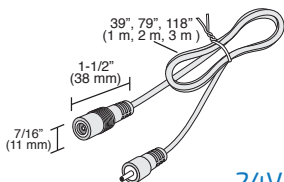

Part #	Description
L-24BBEXT-1M-1	1 m (39") 24VDC ML/FML Barrel Extension, White
L-24BBEXT-2M-1	2 m (79") 24VDC ML/FML Barrel Extension, White
L-24BBEXT-3M-1	3 m (119") 24VDC ML/FML Barrel Extension, White

24VDC COB FLEXTAPE USES STANDARD FLEXTAPE LINK CORDS, TEE CONNECTOR AND 90-DEGREE CONNECTOR. SEE PAGE 89



COMPONENTS: POWER SUPPLIES, CONTROLLERS AND MORE SEE PAGE 141.



Tunable

12VDC
24VDC

TAPE



12VDC

NEW!

White Tunable FlexTape®

3W/ft.
(9.8W/m)

345 Lumens
per ft.
(1132 per meter)



Changing your light source's color temperature is easy with Tresco® White Tunable CCT FlexTape® lighting solution. Select between warmer lighting that highlights natural wood grains and earth tones or cool lighting to highlight whites; perfect for cabinet, task or accent lighting and store fixtures. The low profile and adhesive 3M™ backing give this LED lighting solution the versatility to install in a multitude of places. Eliminate the guesswork and get the LED that pairs perfectly with your general lighting and overall design.

Features:

115° beam angle

High output (345 lumens per ft.)

White tunable from 2700K-6500K

Sold in 16.4' (5 m) roll

Cuttable every 1" (25 mm)

No soldering required – simple FlexConnect connectors (sold separately)

Precision tunable remote controls (sold separately)

Typical Applications:

Under Cabinet

Interior Cabinets

Accent Lighting

Displays

Task Lighting

Store fixtures

Toe kick

Soffit

Backlighting



Cuttable every 1" (25 mm)



2700K



3500K



6500K

Eliminate the guesswork and get the LED that pairs perfectly with your general lighting and overall design.



No soldering required – simple FlexConnect connectors (sold separately)



Strong 300 LSE 3M™ adhesive backing



Dimensions:

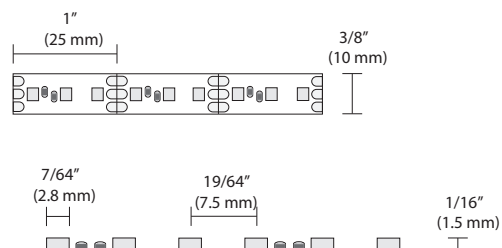

White Tunable FlexTape® can be used as a DIY option for flush and recessed Infinex. For other profiles, must be custom ordered.

Typical Setup:

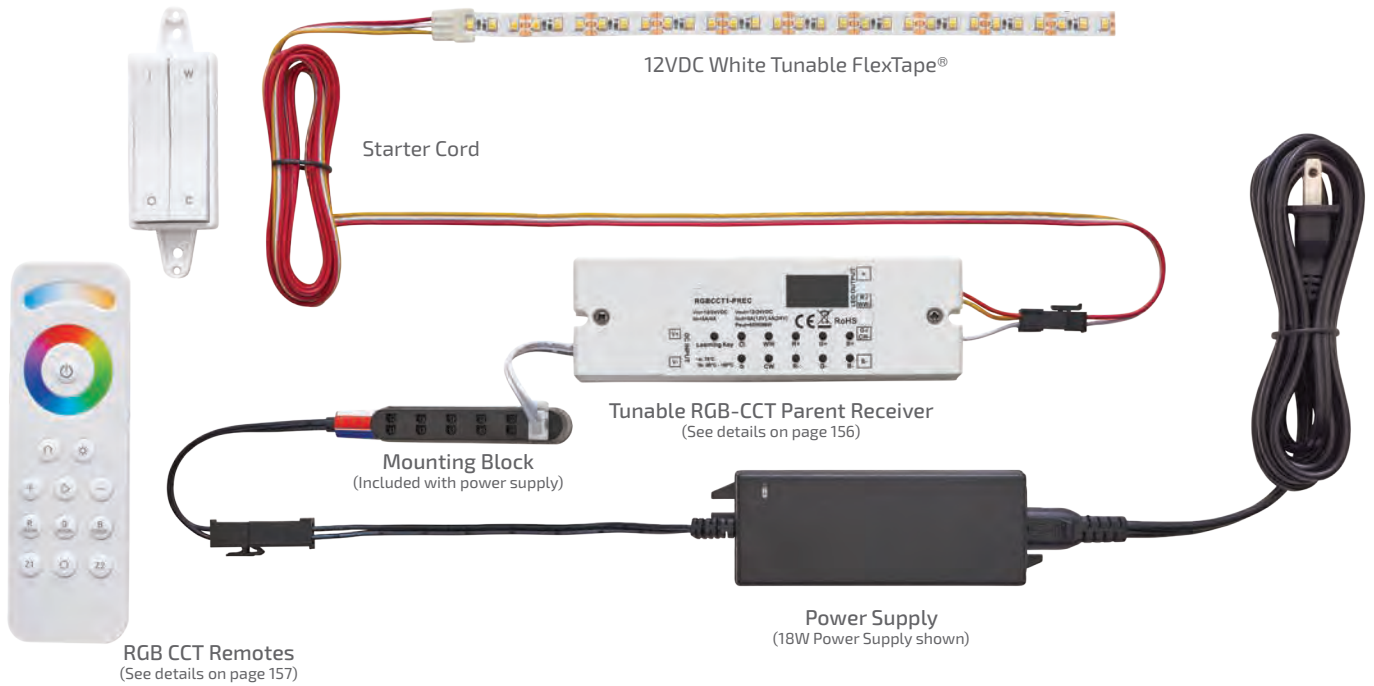

- Required
- Optional

Accessories:

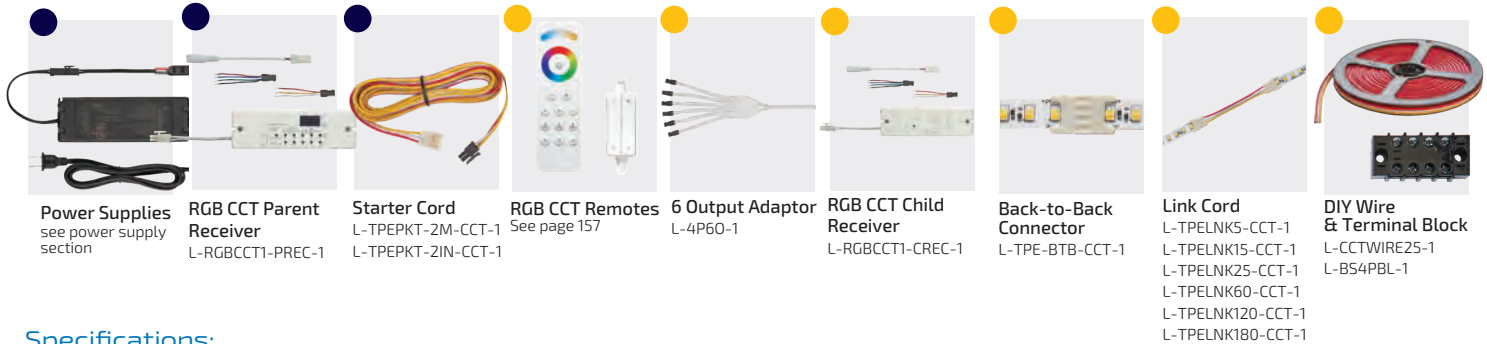

Specifications:

Wattage	Lumens	Efficacy (lm/W)	Input Voltage	Diode Life	Max Per Power Supply 60W	Max Continuous Run	Mounting	Warranty	Beam Angle												
3W/ft. (9.8W/m)	345 per ft. (1132 per m)	115	12VDC	50,000 Hours	20' (6 m)	16.4' (5 m)	Surface	5 Year													
Photometric Data					Color Temperature																
<table border="1"> <thead> <tr> <th>Height</th> <th>Light Output</th> <th>Beam Area</th> </tr> </thead> <tbody> <tr> <td>1ft (.3 m)</td> <td>114Fc (1227lx)</td> <td>3.2ft L x 3ft W (.97 m L x .91 m W)</td> </tr> <tr> <td>3ft (.9 m)</td> <td>12.7Fc (136.7lx)</td> <td>9.7ft L x 9ft W (2.9 m L x 2.7 m W)</td> </tr> <tr> <td>6ft (1.8 m)</td> <td>3.17Fc (34.1lx)</td> <td>19.4ft L x 18.1ft W (5.9 m L x 5.5 m W)</td> </tr> </tbody> </table> <p>L-FLXTPE-12CCT-1 Tested at 4600K</p>					Height	Light Output	Beam Area	1ft (.3 m)	114Fc (1227lx)	3.2ft L x 3ft W (.97 m L x .91 m W)	3ft (.9 m)	12.7Fc (136.7lx)	9.7ft L x 9ft W (2.9 m L x 2.7 m W)	6ft (1.8 m)	3.17Fc (34.1lx)	19.4ft L x 18.1ft W (5.9 m L x 5.5 m W)	<p>Warm White Warm to Neutral Cool White Daylight</p> <p>2700K 3000K 4500K 5500K 6500K</p> <p>Warm (2700K) Daylight (6500K)</p>				
Height	Light Output	Beam Area																			
1ft (.3 m)	114Fc (1227lx)	3.2ft L x 3ft W (.97 m L x .91 m W)																			
3ft (.9 m)	12.7Fc (136.7lx)	9.7ft L x 9ft W (2.9 m L x 2.7 m W)																			
6ft (1.8 m)	3.17Fc (34.1lx)	19.4ft L x 18.1ft W (5.9 m L x 5.5 m W)																			

See page 102 for part numbers and descriptions



24VDC

NEW!

White Tunable FlexTape®

3W/ft.
(9.8W/m)

345 Lumens
per ft.
(1132 per meter)



Changing your light source's color temperature is easy with Tresco® White Tunable CCT FlexTape® lighting solution. Select between warmer lighting that highlights natural wood grains and earth tones or cool lighting to highlight whites; perfect for cabinet, task or accent lighting and store fixtures. The low profile and adhesive 3M™ backing give this LED lighting solution the versatility to install in a multitude of places. Eliminate the guesswork and get the LED that pairs perfectly with your general lighting and overall design.

Features:

115° beam angle

High output (345 lumens per ft.)

White tunable from 2700K-6500K

Sold in 16.4' (5 m) roll

Cuttable every 2" (50 mm)

No soldering required – simple FlexConnect connectors (sold separately)

Precision tunable remote controls (sold separately)

Typical Applications:

Under Cabinet

Interior Cabinets

Accent Lighting

Displays

Task Lighting

Store fixtures

Toe kick

Soffit

Backlighting



Cuttable every 2" (50 mm)



2700K



3500K



6500K

Eliminate the guesswork and get the LED that pairs perfectly with your general lighting and overall design.



No soldering required – simple FlexConnect connectors (sold separately)



Strong 300 LSE 3M™ adhesive backing



Dimensions:

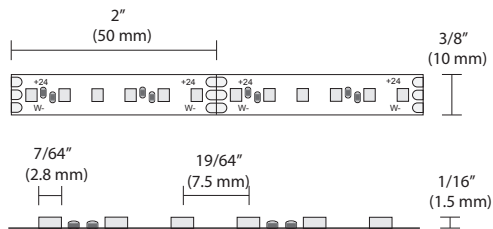

White Tunable FlexTape® can be used as a DIY option for flush and recessed Infinex. For other profiles, must be custom ordered.

Typical Setup:

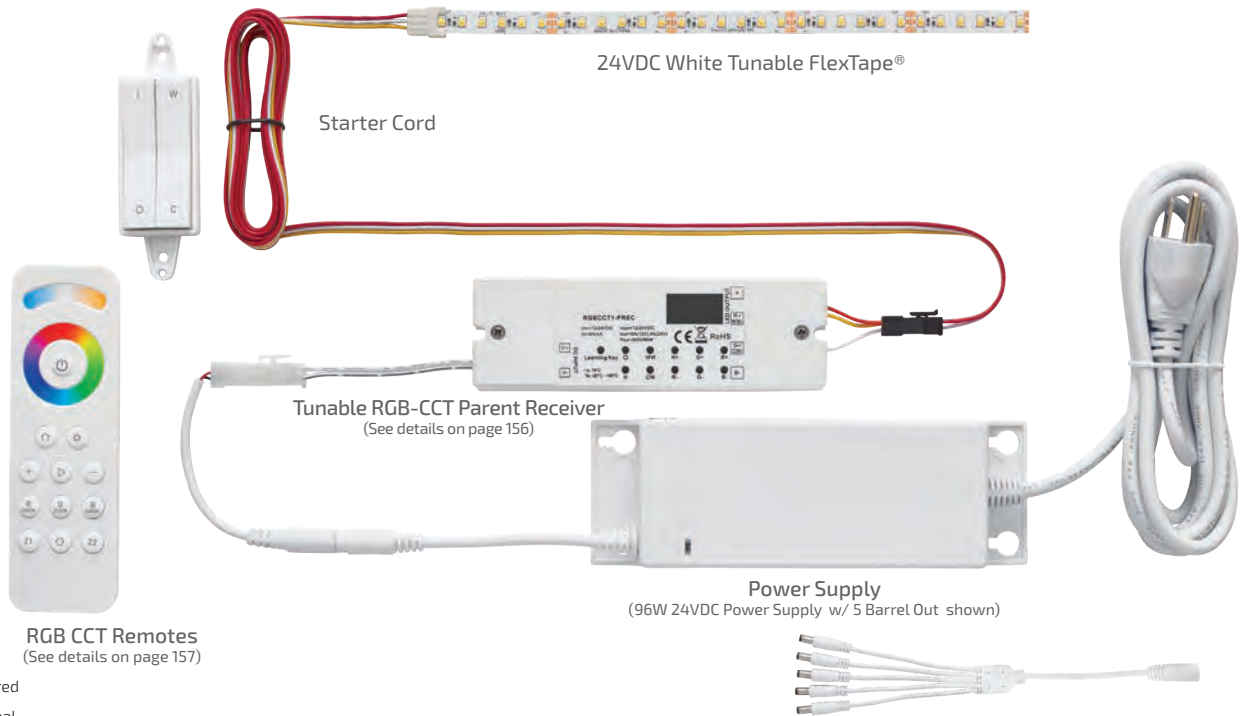

Accessories:

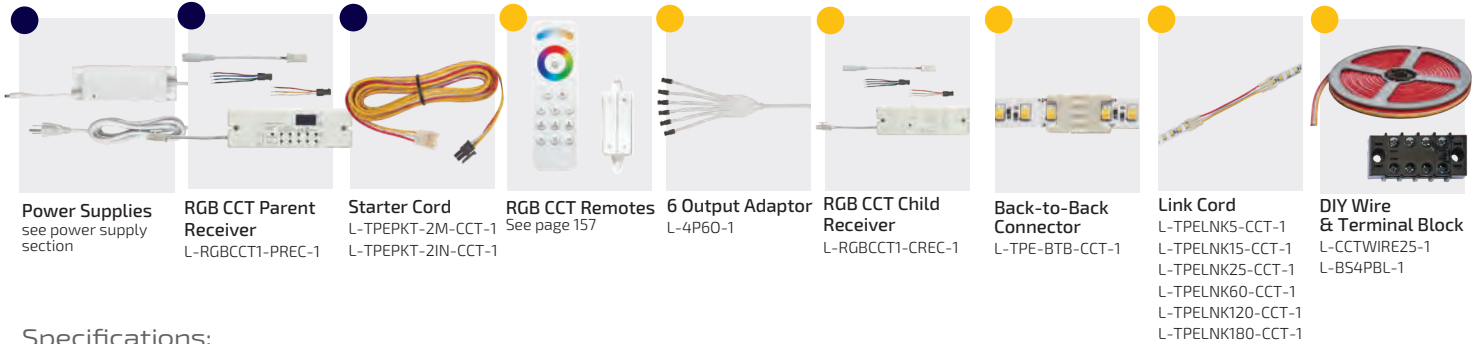

Specifications:

Wattage	Lumens	Efficacy (lm/W)	Input Voltage	Diode Life	Max Per Power Supply 96W	Max Continuous Run	Mounting	Warranty	Beam Angle
3W/ft. (9.8W/m)	345 per ft. (1132 per m)	115	24VDC	50,000 Hours	30'(9m)	16.4' (5 m)	Surface	5 Year	
Photometric Data					Color Temperature				
	Height	Light Output	Beam Area		<p>2700K 3000K 4500K 5500K 6500K</p> <p>Warm (2700K) Daylight (6500K)</p>				
	1ft (.3 m)	114Fc (1227lx)	3.2ft L x 3ft W (.97 m L x .91 m W)						
	3ft (.9 m)	12.7Fc (136.7lx)	9.7ft L x 9ft W (2.9 m L x 2.7 m W)						
6ft (1.8 m)	3.17Fc (34.1lx)	19.4ft L x 18.1ft W (5.9 m L x 5.5 m W)							
L-FLXTPE-24CCT-1 Tested at 4600K									

See page 102 for part numbers and descriptions



12VDC

NEW!

RGB Tunable FlexTape®

BALANCE

4.4W/ft.
(14.4W/m)

Red	Green	Blue
48 Lumens per ft. (157 per meter)	121 Lumens per ft. (397 per meter)	35 Lumens per ft. (115 per meter)



Tresco®'s RGB Balance FlexTape® goes the distance, with 16 million color variations and On-Board Constant Current Regulators creating consistent dramatic lighting is a reality. Created for high-end projects including residential, hospitality and commercial.

Why Balance

All tape lighting has inherent voltage drop. This voltage drop can cause color shift in longer runs of RGB. The On-Board Constant Current Regulators prevent this from happening resulting in balanced color from start to finish.

Features:

120° beam angle

4.4W/ft.

Sold in 13' (4 m) roll

Cutttable every 1-5/8" (42 mm)

No soldering required – simple FlexConnect connectors (sold separately)

Precision tunable remote controls (sold separately)

Typical Applications:

Under Cabinet

Interior Cabinets

Accent Lighting

Displays

Task Lighting

Store fixtures

Toe kick

Soffit

Backlighting



16 million color combinations

Cutttable every 1-5/8" (42 mm)



No soldering required – simple FlexConnect connectors (sold separately)



Strong 300 LSE 3M™ adhesive backing



Dimensions:

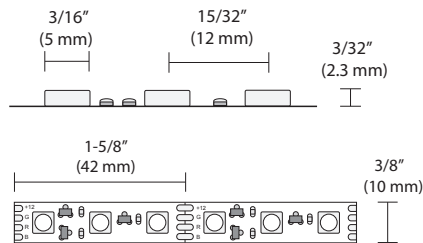

RGB Tunable FlexTape® can be used as a DIY option for flush and recessed Infinix. For other profiles, must be custom ordered.

Typical Setup:

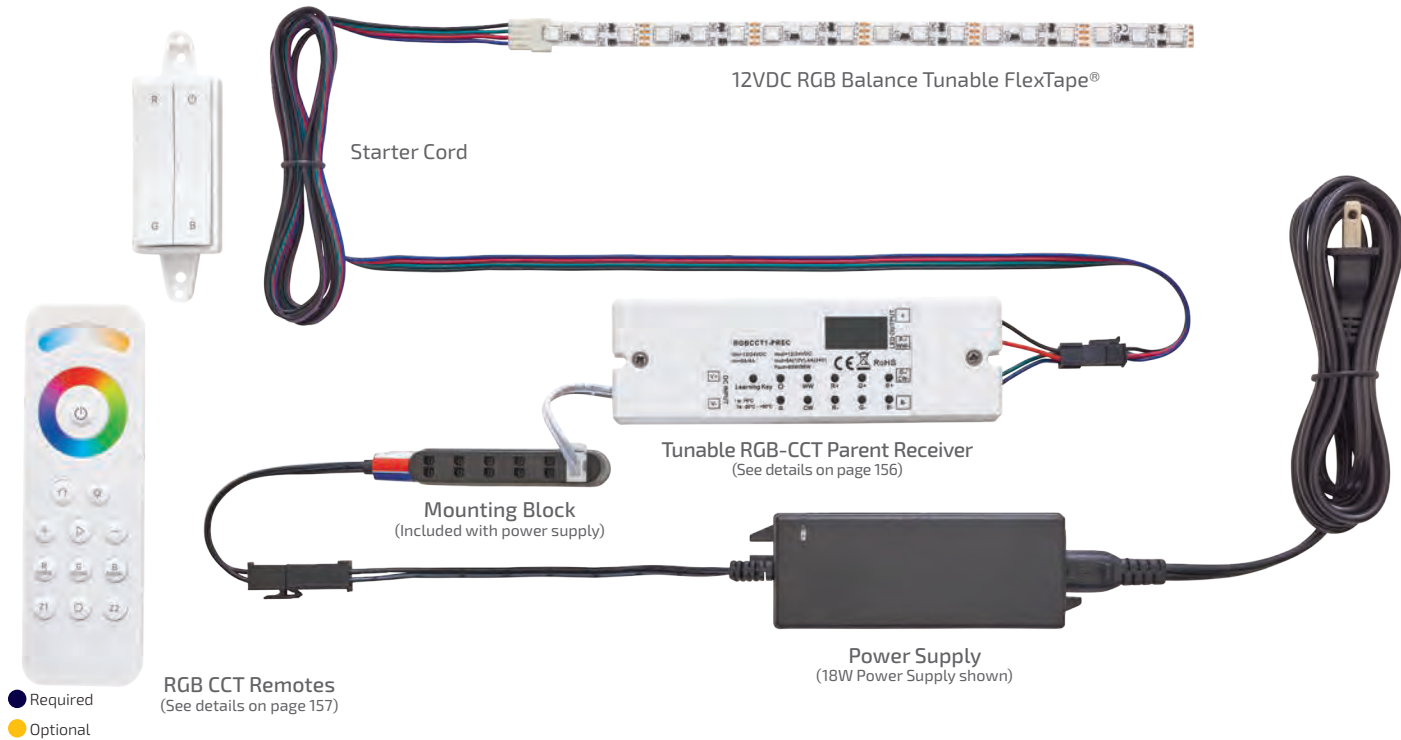

Accessories:

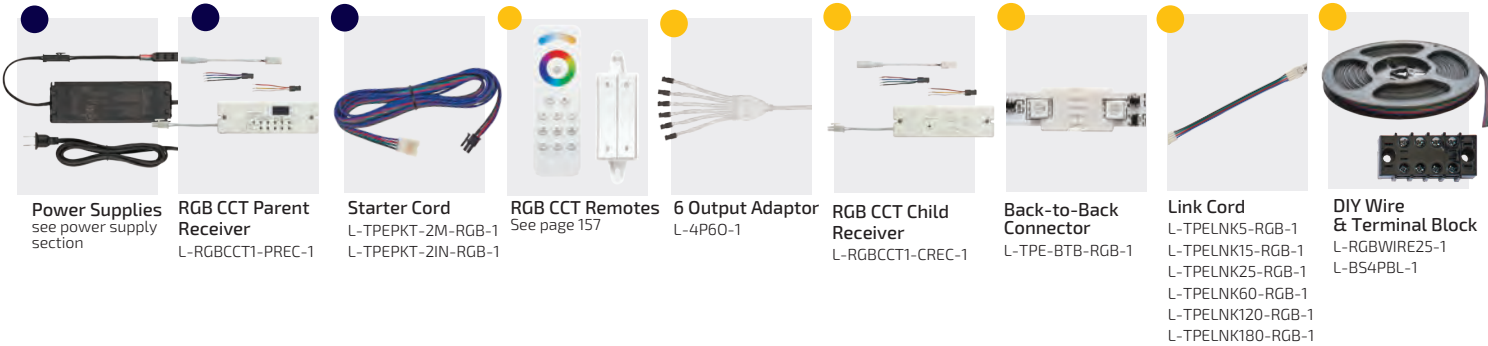

Specifications:

Wattage	Lumens	Input Voltage	Diode Life	Max Per Power Supply 60W	Max Continuous Run	Mounting	Warranty	Beam Angle
4.4W/ft. (14.4W/m)	Red: 48 per ft. (157 per m) Green: 121 per ft. (397 per m) Blue: 35 per ft. (115 per m)	12VDC	50,000 Hours	13' (4 m)	13' (4 m)	Surface	5 Year	

Blue 460 nm Green 520 nm Red 630 nm

400 450 500 550 600 650 700 750

Wavelength (nm)

Wavelengths are averages.

See page 103 for part numbers and descriptions



24VDC

NEW!

RGB Tunable FlexTape®

BALANCE

4.4W/ft.
(14.4W/m)

Red	Green	Blue
51 Lumens per ft. (167 per meter)	117 Lumens per ft. (384 per meter)	41 Lumens per ft. (135 per meter)



Tresco®'s RGB Balance FlexTape® goes the distance, with 16 million color variations and On-Board Constant Current Regulators creating consistent dramatic lighting is a reality. Created for high-end projects including residential, hospitality and commercial

Why Balance

All tape lighting has inherent voltage drop. This voltage drop can cause color shift in longer runs of RGB. The On-Board Constant Current Regulators prevent this from happening resulting in balanced color from start to finish.

Features:

120° beam angle

4.4W/ft.

Sold in 16.4' (5 m) roll

Cuttable every 3-1/4" (83 mm)

No soldering required – simple FlexConnect connectors (sold separately)

Precision tunable remote controls (sold separately)

Typical Applications:

Under Cabinet

Interior Cabinets

Accent Lighting

Displays

Task Lighting

Store fixtures

Toe kick

Soffit

Backlighting



Dimensions:

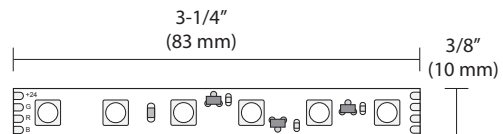
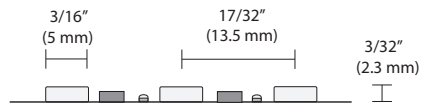

RGB Tunable FlexTape® can be used as a DIY option for flush and recessed Infinex. For other profiles, must be custom ordered.



Cuttable every 3-1/4" (83 mm)



16 million color combinations



No soldering required – simple FlexConnect connectors (sold separately)







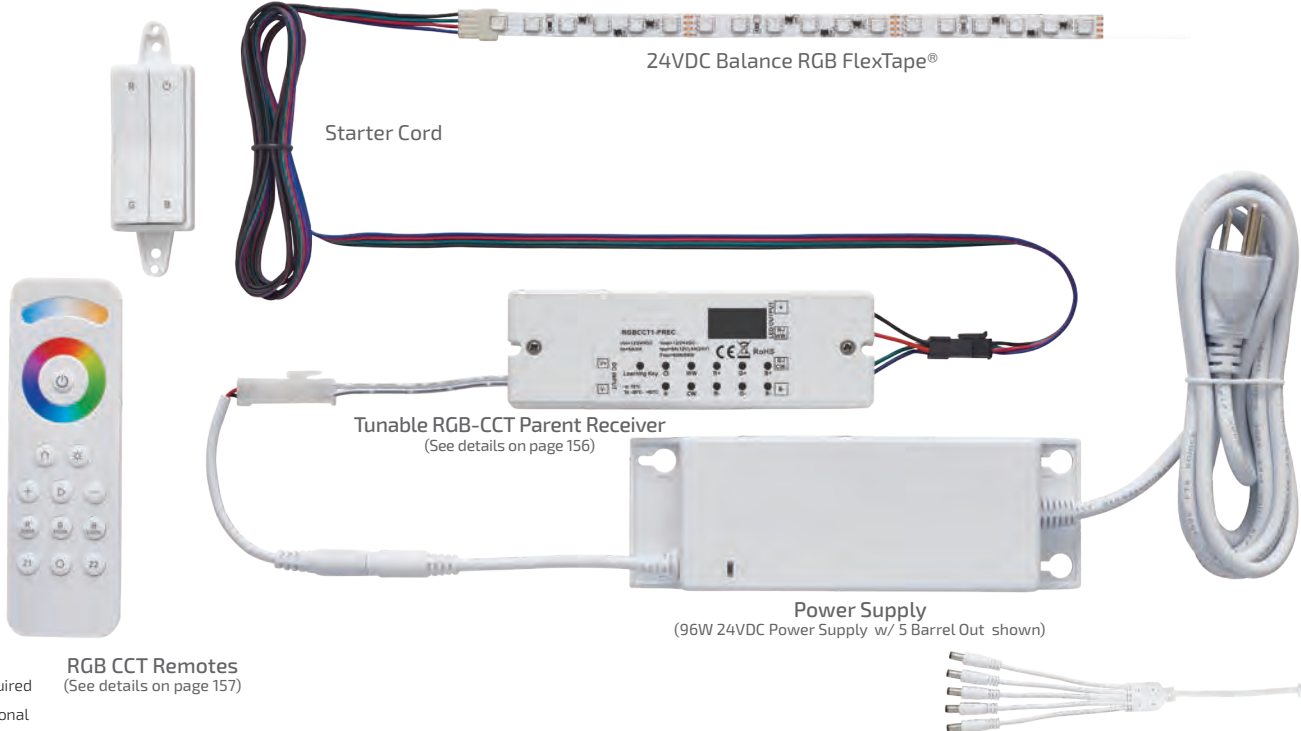



Strong 300 LSE 3M™ adhesive backing

Typical Setup:

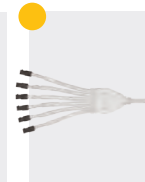
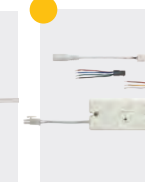

- Required RGB CCT Remotes (See details on page 157)
- Optional

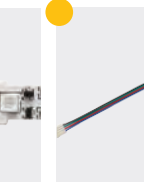
Accessories:

								
Power Supplies see power supply section	RGB CCT Parent Receiver L-RGBCCT1-PREC-1	Starter Cord L-TPEPKT-2M-RGB-1 L-TPEPKT-2IN-RGB-1	RGB CCT Remotes See page 157	6 Output Adaptor L-4P60-1	RGB CCT Child Receiver L-RGBCCT1-CREC-1	Back-to-Back Connector L-TPE-BTB-RGB-1	Link Cord L-TPELNK5-RGB-1 L-TPELNK15-RGB-1 L-TPELNK25-RGB-1 L-TPELNK60-RGB-1 L-TPELNK120-RGB-1 L-TPELNK180-RGB-1	DIY Wire & Terminal Block L-RGBWIRE25-1 L-BS4PBL-1

Specifications:

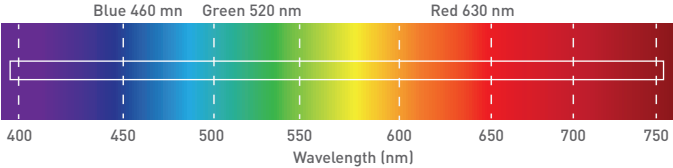
Wattage	Lumens	Input Voltage	Diode Life	Max Per Power Supply 96W	Max Continuous Run	Mounting	Warranty	Beam Angle
4.4W/ft. (14.4W/m)	Red: 51 per ft. (167 per m) Green: 117 per ft. (384 per m) Blue: 41 per ft. (135 per m)	24VDC	50,000 Hours	21' (6.4 m)	16.4' (5 m)	Surface	5 Year	
 <p style="text-align: center;">Wavelengths are averages.</p>								

See page 103 for part numbers and descriptions



24VDC

NEW!

RGB Tunable FlexTape®

STANDARD

4.4W/ft.
(14.4W/m)

Red	Green	Blue
51 Lumens per ft. (167 per meter)	117 Lumens per ft. (384 per meter)	41 Lumens per ft. (135 per meter)



Creating dramatic lighting with 16 million colors is a reality with Tresco Lightings RGB Standard color-changing FlexTape®. Created and priced for everyday projects.



16 million color combinations

Cuttable every 2-13/16" (71 mm)



No soldering required – simple FlexConnect connectors (sold separately)



Strong 300 LSE 3M™ adhesive backing

Features:

120° beam angle

4.4W/ft.

Sold in 16.4' (5 m) roll

Cuttable every 2-13/16" (71 mm)

No soldering required – simple FlexConnect connectors (sold separately)

Precision tunable remote controls (sold separately)

Typical Applications:

Under Cabinet

Interior Cabinets

Accent Lighting

Displays

Task Lighting

Store fixtures

Toe kick

Soffit

Backlighting



Dimensions:

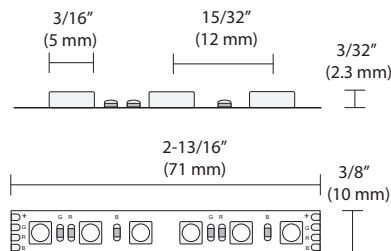

RGB Tunable FlexTape® can be used as a DIY option for flush and recessed Infinix. For other profiles, must be custom ordered.

Typical Setup:

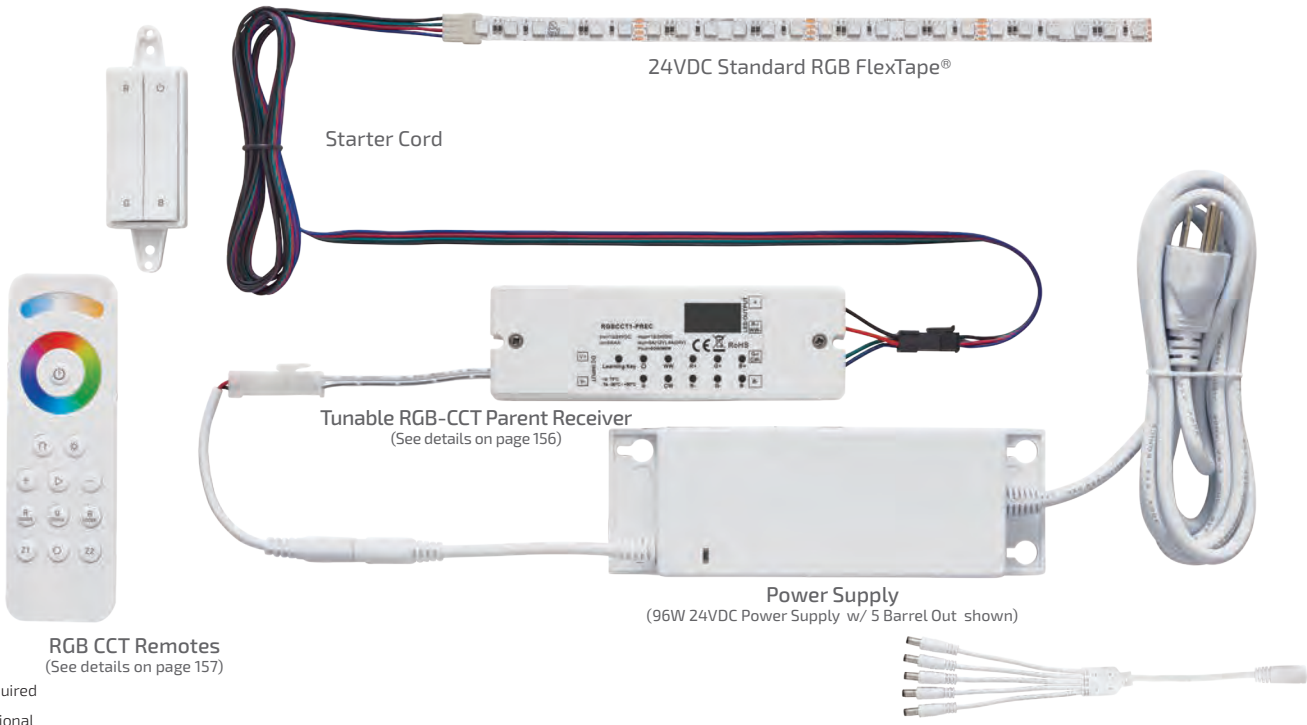

Accessories:

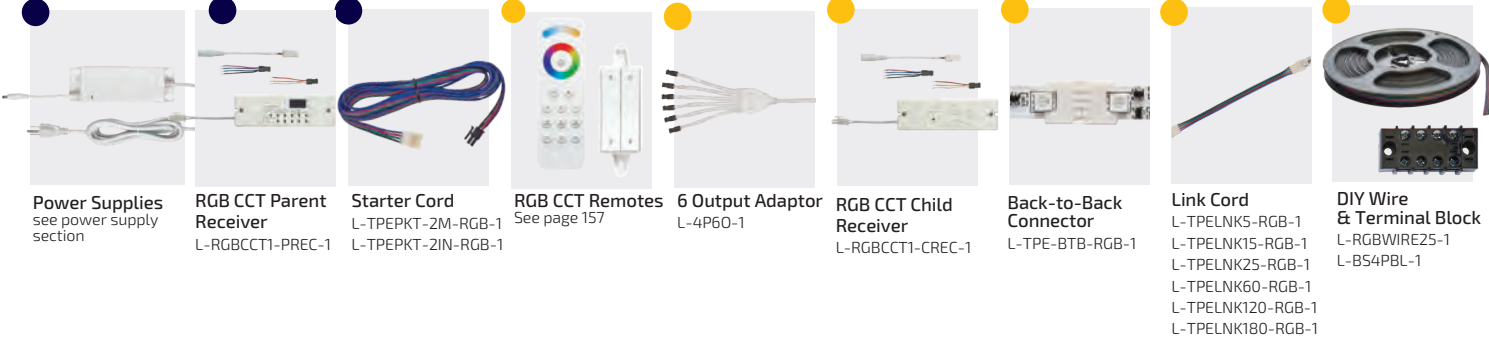

Specifications:

Wattage	Lumens	Input Voltage	Diode Life	Max Per Power Supply 96W	Max Continuous Run	Mounting	Warranty	Beam Angle
4.4W/ft. (14.4W/m)	Red: 51 per ft. (167 per m) Green: 117 per ft. (384 per m) Blue: 41 per ft. (135 per m)	24VDC	50,000 Hours	21' (6.4 m)	16.4' (5 m)	Surface	5 Year	120°
<p>Blue 460 nm Green 520 nm Red 630 nm</p> <p>400 450 500 550 600 650 700 750</p> <p>Wavelength (nm)</p> <p>Wavelengths are averages.</p>								

See page 103 for part numbers and descriptions

- Required
- Optional

● 12/24VDC White Tunable FlexTape®

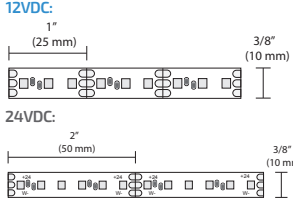

Part

Description

L-FLXTPE-12CCT-1	12VDC 3W/FT CCT FlexTape® 16.4' (5 m) Roll
L-FLXTPE-24CCT-1	24VDC 3W/FT CCT FlexTape® 16.4' (5 m) Roll

Maximum continuous run is 16.4' (5 m). Maximum per power supply is 12VDC: 20' (6 m), 24VDC: 30' (5 m). Mounts with adhesive backing. 12VDC is cuttable every 1" (25 mm), 24VDC is cuttable every 2" (50 mm). To be used on clean, smooth surfaces. Pressure must be applied for proper 3M™ tape adhesion.

● 12/24VDC Power Supplies



For details see Power Supplies on Page 142.

Power supplies for 12VDC work with 12VDC CCT FlexTape®, Power supplies for 24VDC work with 24VDC CCT FlexTape®

● 12/24VDC CCT Starter Cord

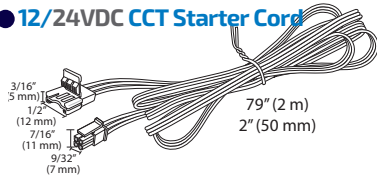

Part

Description

L-TPEPKT-2M-CCT-1	2 m (79") FlexTape CCT Starter Lead
L-TPEPKT-2IN-CCT-1	50 mm (2") FlexTape CCT Starter Lead

5/8" (16 mm) hole required.
Maximum linear run of White Tunable FlexTape® LED from one starter cord is 16.4' (5 m).

● 12/24VDC RGB-CCT Receivers

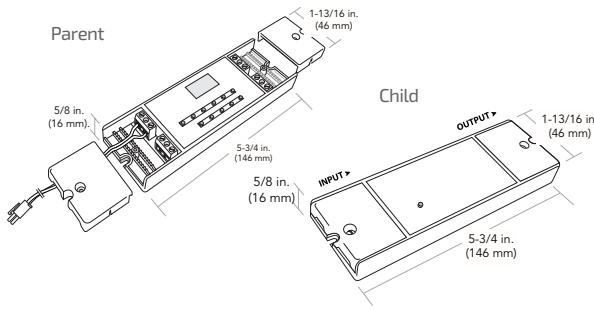

Part

Description

L-RGBCCT1-PREC-1	12/24VDC RGBCCT Parent Controller/Receiver
L-RGBCCT1-CREC-1*	12/24VDC RGBCCT Child Controller/Receiver

*Child Receiver is optional
6 output adaptor sold separately

● 12/24VDC RGB-CCT Remotes

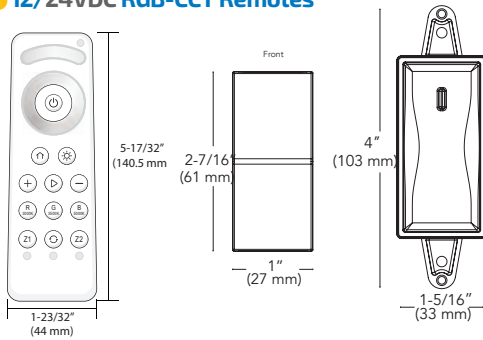

Part

Description

L-RGBCCT-RMT-1	RGBCCT Wireless Remote
L-WLD-CCT-WH-1	CCT FREEDiM Deco Wall Dimmer White
L-WLD-RGB-WH-1	RGB FREEDiM Deco Wall Dimmer White

● 12/24VDC Starter CCT Extension Leads

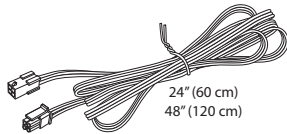

Part

Description

L-CCTEXT-60-1	60 cm (24") CCT FlexTape Starter Extension Lead
L-CCTEXT-120-1	120 cm (48") CCT FlexTape Starter Extension Lead

● 12/24VDC CCT Back-to-Back Connector

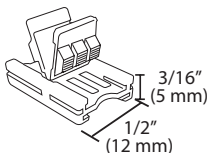

Part

Description

L-TPE-BTB-CCT-1	CCT FlexTape® Back-to-Back Connector
-----------------	--------------------------------------

● 12/24VDC 6 Output Adaptor

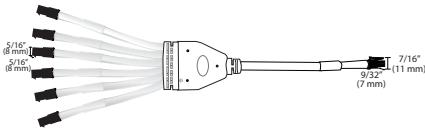

Part #	Description
L-4P60-1	4 Position, 6 Output Adaptor - White

● 12/24VDC CCT Link Cords

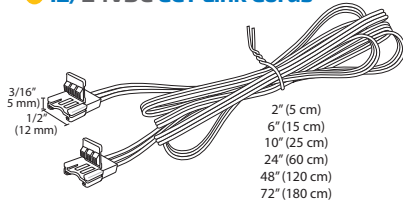

Part #	Description
L-TPELNK5-CCT-1	5 cm (2") CCT FlexTape® Link Cord
L-TPELNK15-CCT-1	15 cm (6") CCT FlexTape® Link Cord
L-TPELNK25-CCT-1	25 cm (10") CCT FlexTape® Link Cord
L-TPELNK60-CCT-1	50 cm (24") CCT FlexTape® Link Cord
L-TPELNK120-CCT-1	120 cm (48") CCT FlexTape® Link Cord
L-TPELNK180-CCT-1	180 cm (72") CCT FlexTape® Link Cord

● 12/24VDC CCT DIY

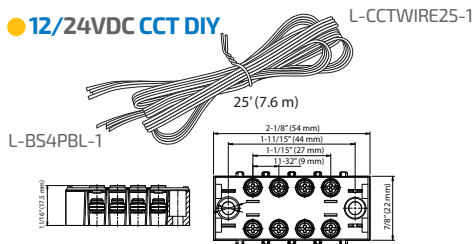

Part #	Description
L-CCTWIRE25-1	25' (7.6 m) 20AWG CCT Wire Roll
L-BS4PBL-1	12/24VDC Barrier Splice 4 Position Black

● 12/24VDC RGB Tunable FlexTape®

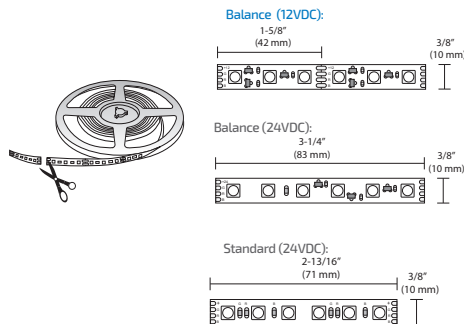

Part #	Description
L-FLXTPE-12RGB-1	12VDC 4.4W/FT RGB FlexTape W/IC 13' (4 m) Roll
L-FLXTPE-24RGB-1	24VDC 4.4W/FT RGB FlexTape W/IC 16.4' (5 m) Roll
L-TPELED-24RGB-1	24VDC 4.4W/FT RGB Tape LED 16.4' (5 m) Roll

Maximum continuous run is 13' (4 m) for 12VDC and 16.4' (5 m) for 24VDC. Maximum per power supply is 12VDC: 13' (4 m), 24VDC: 16.4' (5 m). Mounts with adhesive backing. Standard 24VDC is cuttable every 2-13/16" (71 mm), RGB Balance 12VDC is cuttable every 1-5/8" (42 mm), RGB Balance 24VDC is cuttable every 3-1/4" (83 mm). To be used on clean, smooth surfaces. Pressure must be applied for proper 3M™ tape adhesion.

● 12/24VDC Power Supplies



For details see Power Supplies on Page 142.

Power supplies for 12VDC work with 12VDC RGB FlexTape®, Power supplies for 24VDC work with 24VDC RGB FlexTape®

● 12/24VDC RGB Starter Cord

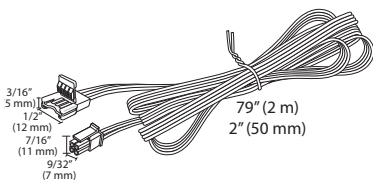

Part #	Description
L-TPEPKT-2IN-RGB-1	50 mm (2") FlexTape RGB Starter Lead
L-TPEPKT-2M-RGB-1	2 m (79") FlexTape RGB Starter Lead

5/8" (16 mm) hole required.
Maximum linear run of RGB Tunable FlexTape® LED from one starter cord is 16.4' (5 m).

- Required
- Optional

12/24VDC RGB-CCT Receivers

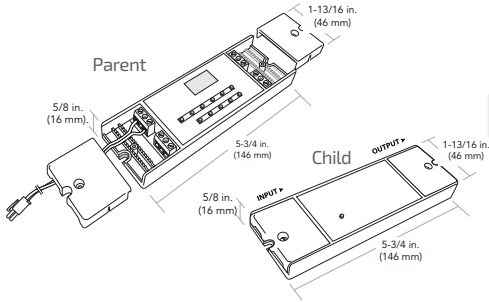

Part

Description

L-RGBCCT1-PREC-1	12/24VDC RGBCCT Parent Controller/Receiver
L-RGBCCT1-CREC-1*	12/24VDC RGBCCT Child Controller/Receiver

*Child Receiver is optional
6 output adaptor sold separately.

12/24VDC RGB-CCT Remotes

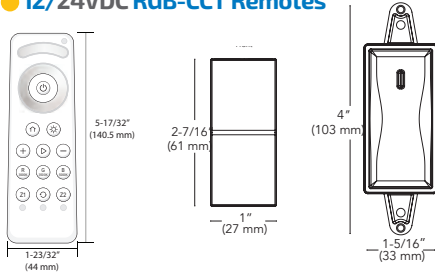

Part

Description

L-RGBCCT-RMT-1	RGBCCT Wireless Remote
L-WLD-CCT-WH-1	CCT FREEDiM Deco Wall Dimmer White
L-WLD-RGB-WH-1	RGB FREEDiM Deco Wall Dimmer White

12/24VDC RGB Starter Extension Leads

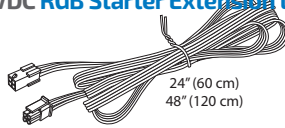

Part

Description

L-RGBEXT-60-1	60 cm (24") RGB FlexTape Starter Extension Lead
L-RGBEXT-120-1	120 cm (48") RGB FlexTape Starter Extension Lead

12/24VDC RGB Back-to-Back Connector

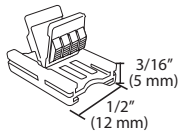

Part

Description

L-TPE-BTB-RGB-1	RGB FlexTape® Back-to-Back Connector
-----------------	--------------------------------------

12/24VDC 6 Output Adaptor

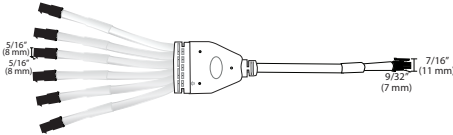

Part

Description

L-4P60-1	4 Position, 6 Output Adaptor - White
----------	--------------------------------------

12/24VDC RGB Link Cord

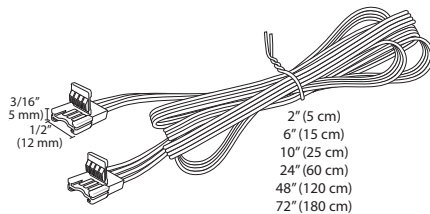

Part

Description

L-TPELNK5-RGB-1	5 cm (2") RGB FlexTape® Link Cord
L-TPELNK15-RGB-1	15 cm (6") RGB FlexTape® Link Cord
L-TPELNK25-RGB-1	25 cm (10") RGB FlexTape® Link Cord
L-TPELNK60-RGB-1	60 cm (24") RGB FlexTape® Link Cord
L-TPELNK120-RGB-1	120 cm (48") RGB FlexTape® Link Cord
L-TPELNK180-RGB-1	180 cm (72") RGB FlexTape® Link Cord

12/24VDC RGB DIY

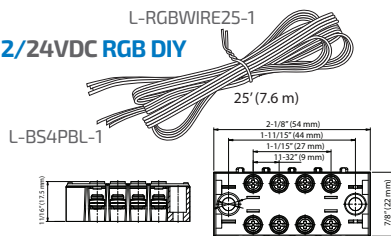

Part

Description

L-RGBWIRE25-1	25' (7.6 m) 22AWG RGB Wire Roll
L-BS4PBL-1	12/24VDC Barrier Splice 4 Position Black



12VDC
24VDC

EXTRUSION

12VDC
24VDC

Infinex

Infinex is the innovative, patented, LED aluminum extrusion system by Tresco Lighting. Gone are the days of set fixture sizes, simply choose your style, cut to desired length and assemble to create a customized LED fixture. Designed by our in-house engineers and made in the USA, Infinex carries a UL safety certification and is available in six profiles with an array of installation options.

Infinex is designed for easy DIY application. We also offer prefabricated custom solutions with a minimum quantity order.

US PATENT NO: D783,533 and 9,618,194



6 profiles to choose from



FlexTape® slides into proprietary power feed end cap



Clear, frosted and milk diffusers snap on/off for easy installation and removal.

Mounting Types:

SCREW



U-CLIP



SWIVEL CLIP

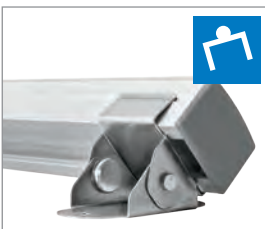

MAGNET



RECESSED



See individual profiles for mounting options available



System Components

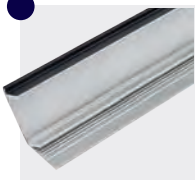

Extrusions

- L-XANG72-SC-1
- L-XANG72-**-1
- L-XCRV72-SC-1
- L-XCRV72-**-1
- L-XREC72-SC-1
- L-XREC94-SC-1
- L-XREC72-BL-1
- L-XREC94-BL-1
- L-XRND72-SC-1
- L-XRND72-BL-1
- L-XSQR72-SC-1
- L-XSQR72-**-1
- L-XFL72-SC-1
- L-XFL94-SC-1



Diffusers

- L-X72-DIFF-CL-1
- L-X72-DIFF-FR-1
- L-X72-DIFF-MLK-1



End Cap Sets

- L-XANGECP-GY-1
- L-XANGECP-**-1
- L-XCRVECP-GY-1
- L-XCRVECP-**-1
- L-XRECECP-GY-1
- L-XRECECP-BL-1
- L-XRNDECP-GY-1
- L-XRNDECP-BL-1
- L-XSQRECP-GY-1
- L-XSQRECP-**-1



Starter Cord

- 12VDC:
- L-XPKT-2M-WH-1
- L-XPKT-2IN-WH-1
- L-XPKT-2M-BL-1
- L-XPKT-2IN-BL-1
- 24VDC:
- L-24XPKT-2M-BL-1
- L-24XPKT-2M-WH-1

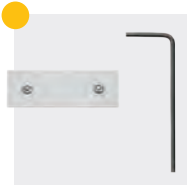

Couplers

- L-EXTBTB10-1

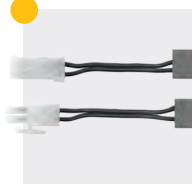

Linking Cords

- L-XLNK-15-**-1
- L-XLNK-25-**-1
- L-XLNK-60-**-1
- L-XLNK-120-**-1
- L-XLNK-180-**-1



Mounting Plates

- L-EXTMP-VHB-1



U-Clips

- L-XRND-UCLP-1
- L-XSQR-UCLP-1
- L-XSQRSWCLP-1



Magnet

- L-XRM42-155-1

CUSTOM SOLUTIONS

Take control of your lighting through Tresco's custom Infinex solutions. From length, to light output, to screw versus magnetic mounting, you dictate the options of your unique fixture. Once decided, we will manufacture it in our USA headquarters. No more worries about international shipping delays or extended holidays. Every light is quality checked and bears the cULus marking denoting its safe operation. Don't settle for something "close", choose Infinex and get exactly what you want. Go to trescolighting.com to submit your project and receive a custom quote.

CUSTOM FULLY ASSEMBLED FIXTURES

NO MINIMUM REQUIREMENT

MADE IN THE U.S.A. AND SHIPS WITHIN 7 DAYS!



- 6 unique profiles
- 30 light output options
- Black or white cords (multiple lengths)
- 4"- 96" (101 mm - 2438 mm) fixture lengths in 1/16" (1.6 mm) increments
- 3 diffuser options (clear, frosted, milk)
- Bulk, individual, or kit packaged
- No minimum quantity required
- Quick turnaround

NEW! INFINEX INTEGRATED CONTROL OPTIONS

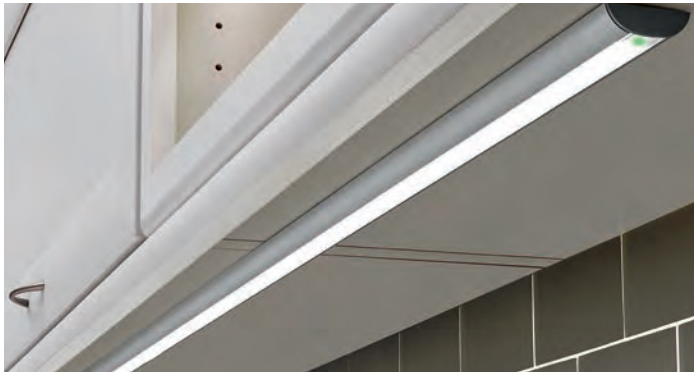

Dimmer Only



Dimmer/Motion Combo

Features:

Controls are elegantly and fully integrated into the made-to-order Infinex fixture

ON/OFF and dimming controls use a glowing digital button for easy visual recognition

An optional fully-integrated occupancy sensor available to automatically turn the fixture off after 30-minutes of no activity or Tresco® can customize the desired time delay

Easily switch between manual and occupancy sensor modes

Returns to last setting when turned on

Typical Applications:

- Hospitality applications utilizing the integrated occupancy sensor for for:
 - Hotel or hospital closet, vanity or headboard lighting
 - Task lighting for nurses' stations
- Attach under: furniture and bathroom cabinetry
- Office furniture: task lighting under overhead shelves, bins, cabinets and privacy booths
- Under residential or commercial cabinetry to illuminate a countertop and/or backsplash
- Retail: utilize the integrated occupancy sensor to turn display lighting on when customers approach

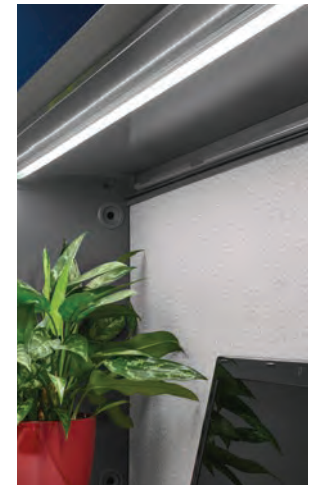

Dimmer Only

- Touch ON/OFF
- Gradual dimming from 100%-5%
- Power failure memory (retains last setting)
- 10 hour automatic energy saving shutoff

Dimmer/Motion Sensor Combo

- 4 step dimming 100/75/50/25
- 30 minute preset motion sensor*
- Motion sensor can be deactivated
- Dimmer works in motion sensor mode or standalone mode
- 10 hour automatic energy saving shutoff in dimmer only mode

*Motion sensor time can be customized by Tresco® Lighting

Not sold individually for DIY Infinex

BLEND SERIES



See "At a Glance" chart for extrusion styles and finishes available



Available in a variety of finishes. Custom finishes also available

In Stock



Black (BL)



Dark Cherry (DC)



Natural Soft Maple (NSM)



Satin Nickel (SC)



White (WH)



Sample rings available

Available with 1000 Ft. Min. Order



Medium Cherry



Light Cherry



Contemporary Cherry



Walnut



Natural Oak



Dark Oak



Pear



Color Matching*

* Color Matching will match any color sample and is available with 1000 ft. minimum order

DIY INFINEX

1 DESIGN YOUR LIGHT

1a PROFILE SHAPE

6 unique profiles to choose from!

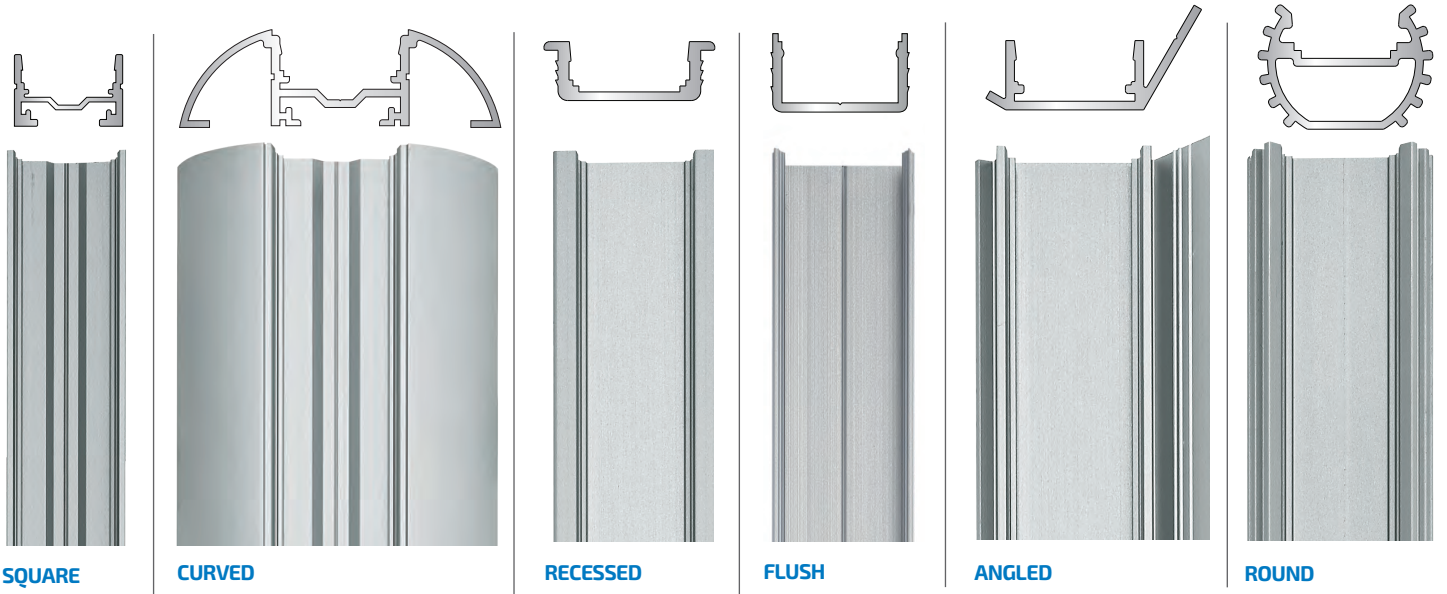

1b PICK YOUR FINISH

Available in a variety of finishes. Custom finishes also available. Not all finishes available with all shapes.



1c DIFFUSER

Clear, frosted and milk diffusers



1d LIGHT OUTPUT

Ranging from 1.5W to 5.5W



1e STARTER CORD

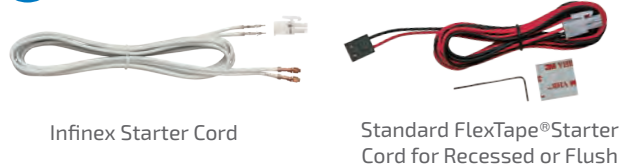

1f MOUNTING



See individual profiles for mounting options available

EXTRUSION OPTIONS AT A GLANCE

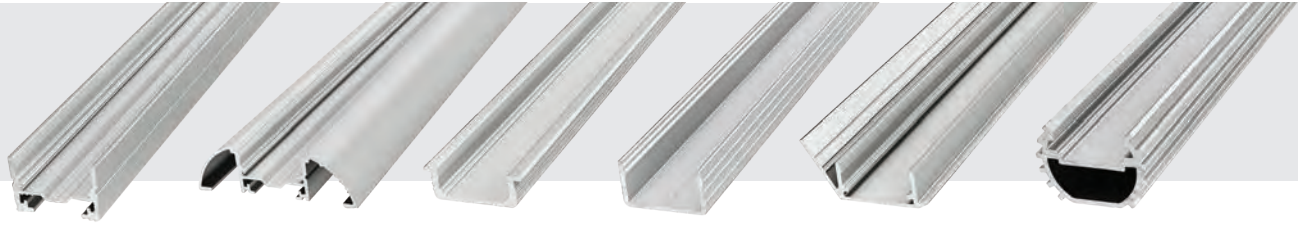

	Square	Curved	Recessed	Flush	Angled	Round
Surface Mounting	Y	Y	Y	Y	Y	Y
Recessed Mounting	N	N	Y	Y	N	N
U-Clip Mounting	Y	Y	Y	Y	N	Y
Magnet Mounting	Y	Y	N	N	N	N
Available Finishes	Satin Nickel, Black, White, Dark Cherry, Natural Soft Maple, Custom	Satin Nickel, Black, White, Dark Cherry, Natural Soft Maple, Custom	Satin Nickel, Black	Satin Nickel	Satin Nickel, Black, White, Dark Cherry, Natural Soft Maple, Custom	Satin Nickel, Black
Available Diffusers	Clear, Frost, Milk	Clear, Frost, Milk	Clear, Frost, Milk	Milk	Clear, Frost, Milk	Clear, Frost, Milk



FLEXTAPE® AND DIFFUSER OPTIONS AT A GLANCE

	1.5W FlexTape®	3W FlexTape®	4.4W FlexTape®	4.4W 12VDC COB FlexTape®	5.5W 24VDC COB FlexTape®	5.5W FlexTape®	1.5W EquiLine Tape	3W EquiLine Tape	4.4W EquiLine Tape
Lumens w/ Clear Infinex Diffuser	125	310	355	210	330	520	115	215	335
Lumens w/ Frosted Infinex Diffuser	115	285	325	195	305	480	105	200	310
Lumens w/ Milk Infinex Diffuser	95	235	270	160	255	395	85	165	255

2 CUT TO SIZE

Aluminum extrusions can be cut by various pieces of equipment. For the best performance and longest life, use a saw blade designed for non-ferrous, thin stock on your miter saw. It is also highly recommended to cut extrusion with diffuser securely attached via clamps, tape, stretch wrap etc. to prevent unwanted cracking of diffuser.

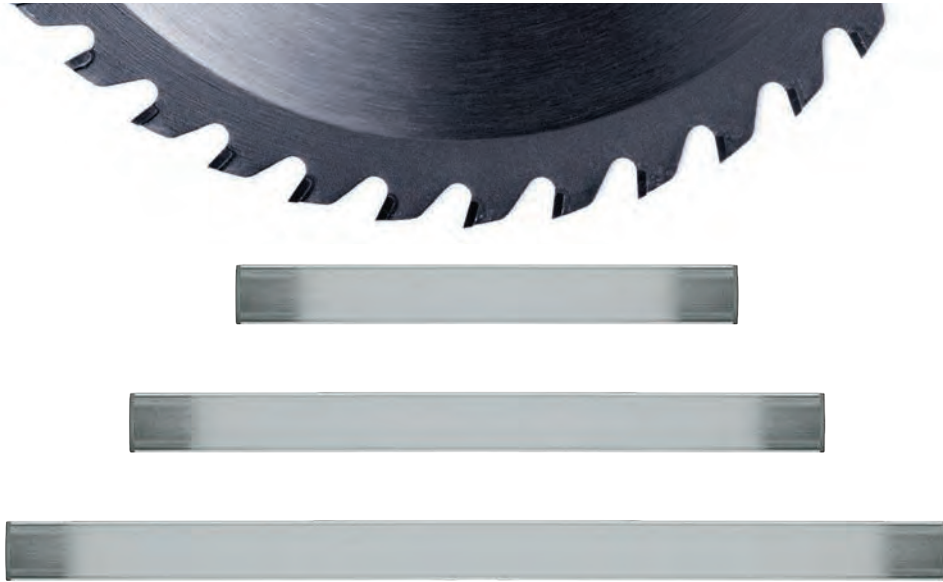

3 ASSEMBLE

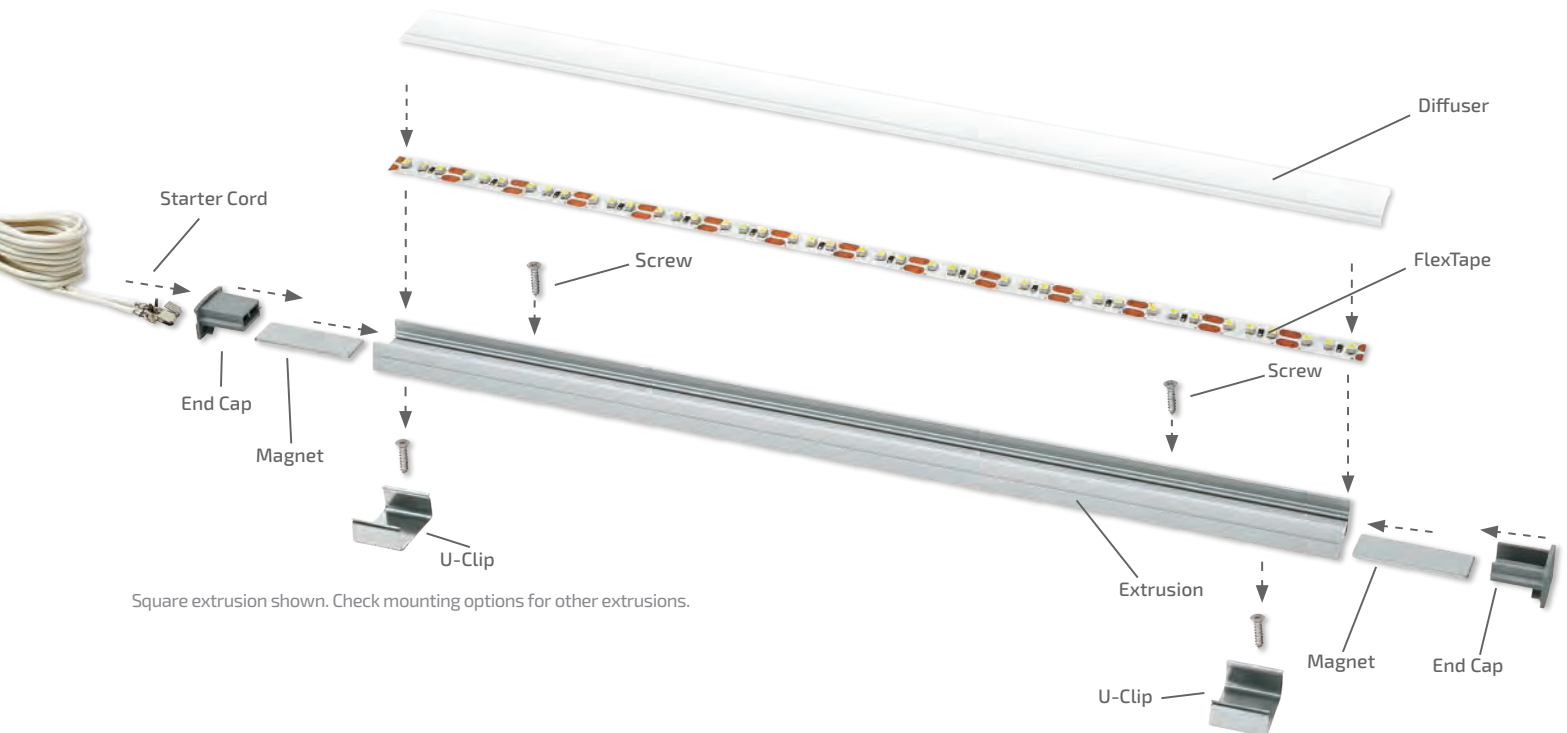

Square extrusion shown. Check mounting options for other extrusions.

EXTRUSION STYLES AND FEATURES

SQUARE



MOUNTING



U-Clips sold separately

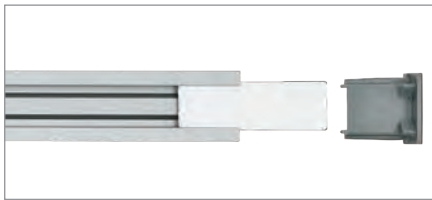

Couplers Sold Separately

Profile

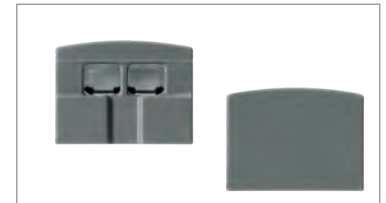
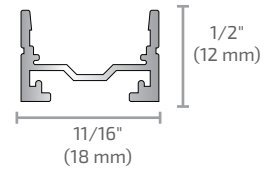

End Caps Sold Separately

Features

- Surface mount using magnets, U-Clips or screws
- Easily slide magnets into channel on bottom of light
- Uses Infinex starter leads

Available stock finishes

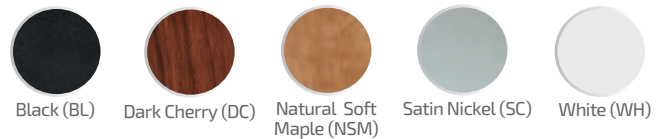

CURVE



MOUNTING



U-Clips sold separately

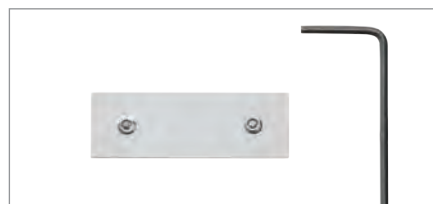

Couplers Sold Separately

Profile

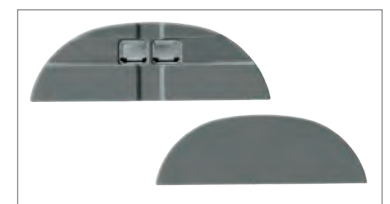
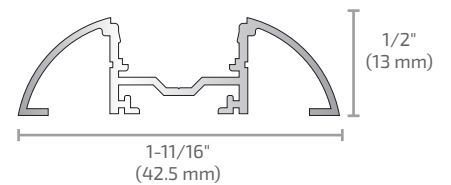

End Caps Sold Separately

Features

- Surface mount using magnets, U-Clips or screws
- Easily slide magnets into channel on bottom of light
- Uses Infinex starter leads

Available stock finishes

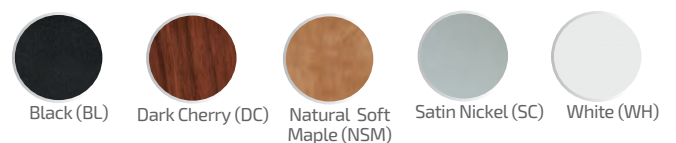

ANGLE



MOUNTING

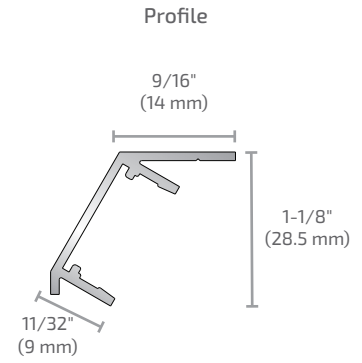
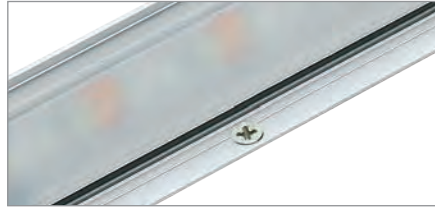

End Caps Sold Separately

Features

For corner mounting with screws only

Fixture directs light at 30° angle

Uses Infinex starter leads

Available stock finishes

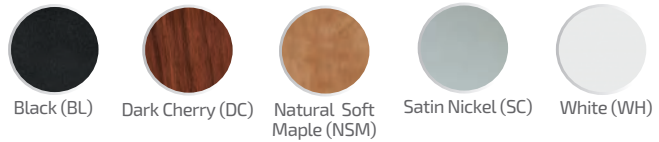

ROUND



MOUNTING



U-Clips sold separately

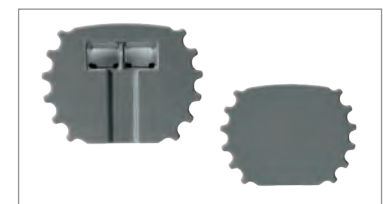
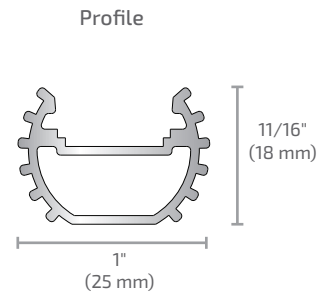

End Caps Sold Separately

Features

U-Clip mounting allows fixture to be rotated in 15° increments either direction (30°, 15°, 0°, -15°, -30°)

Uses Infinex starter leads

Available finishes

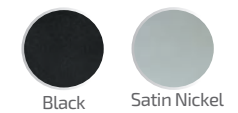

RECESSED

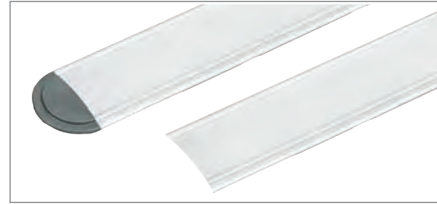
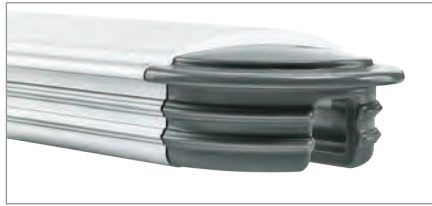

Profile

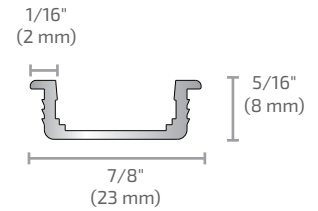

End Caps Sold Separately

Features

Grooved sides allow extrusion to pressure fit into place*

Uses standard FlexTape® starter lead

*With Endcap: Route a channel in wood 21/64" (8.33 mm) depth minimum x .750" (19 mm) width and pressure fit this extrusion in place.

Without Endcap: Route a channel in wood 9/32" (7.14 mm) depth minimum x .750" (19 mm) width and pressure fit this extrusion in place.

Recessed extrusion uses standard FlexTape® starter lead.
(L-LED-TPEPKT-2M-1, L-24B2SPKT-2M-1)

Recessed End Cap Dimensions:

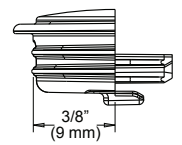
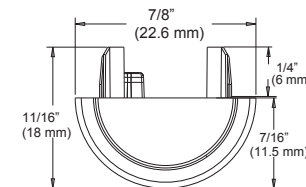
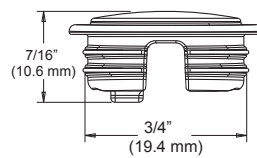

Available finishes

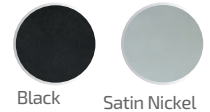

FLUSH



Profile

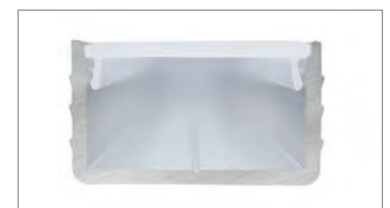
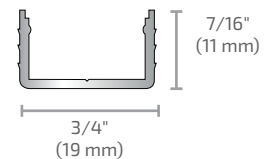

No End Caps

Features

No end caps...this extrusion is meant for channels that go the entire width or height of the casework

Comes with milk diffuser (unattached)

Uses standard FlexTape® starter lead

*Route a channel in wood 7/16" (11 mm) depth x 3/4" (19 mm) width and pressure fit this extrusion in place.

Flush extrusion uses standard FlexTape® starter lead.
(L-LED-TPEPKT-2M-1, L-24B2SPKT-2M-1)

Available finishes

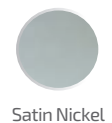

- Required
- Optional

Extrusions

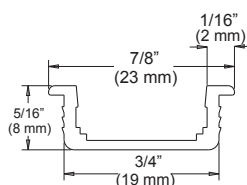
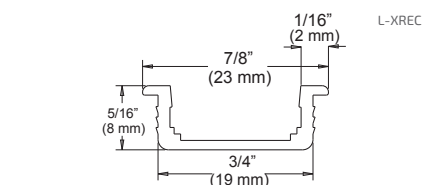
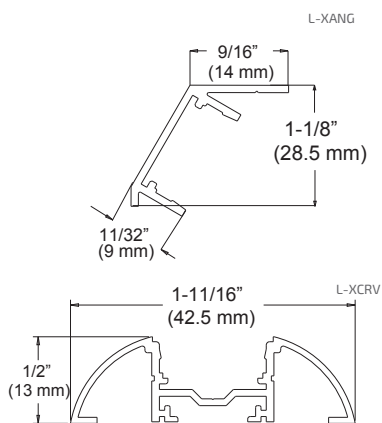

Part #	Description
L-XANG72-SC-1	72" (1.8 m) Angled Extrusion Satin Clear
L-XANG72-**-1	72" (1.8 m) Angled Extrusion Other Finishes
L-XCRV72-SC-1	72" (1.8 m) Curved Extrusion Satin Clear
L-XCRV72-**-1	72" (1.8 m) Curved Extrusion Other Finishes
L-XREC72-SC-1	72" (1.8 m) Recessed Extrusion Satin Clear
L-XREC94-SC-1	94" (2.4 m) Recessed Extrusion Satin Clear
L-XREC72-BL-1	72" (1.8 m) Recessed Extrusion Black
L-XREC94-BL-1	94" (2.4 m) Recessed Extrusion Black
L-XRND72-SC-1	72" (1.8 m) Round Extrusion Satin Clear
L-XRND72-BL-1	72" (1.8 m) Round Extrusion Black
L-XSQR72-SC-1	72" (1.8 m) Square Extrusion Satin Clear
L-XSQR72-**-1	72" (1.8 m) Square Extrusion Other Finishes
L-XFL72-SC-1	72" (1.8 m) Flush Extrusion Satin Clear with Milk Diffuser
L-XFL94-SC-1	94" (2.4 m) Flush Extrusion Satin Clear with Milk Diffuser

**Insert BL for Black, WH for White, DC for Dark Cherry, NSM for Natural Soft Maple

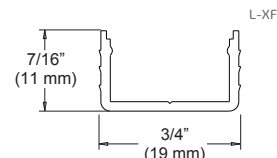
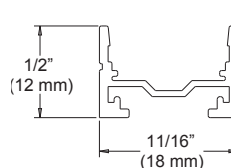
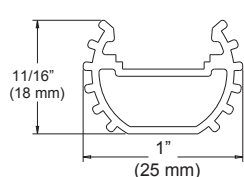

Power Supplies



For details see Power Supplies on Page 142.

Infinex works with all Tresco 12VDC and 24VDC power supplies.

Diffusers

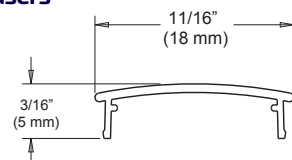

Part #	Description
L-X**-DIFF-CL-1	Diffuser Clear
L-X**-DIFF-FR-1	Diffuser Frosted
L-X**-DIFF-MLK-1	Diffuser Milk

**Insert 72 for 72" (1.8 m) length, or 94 for 94" (2.4 m) length

End Cap Sets

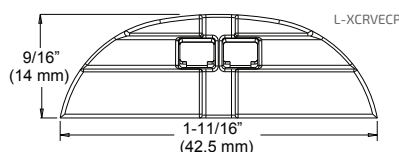
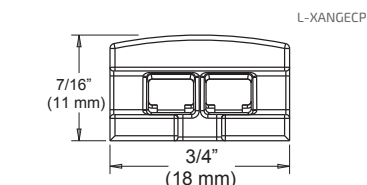

Part #	Description
L-XANGECP-GY-1	Angled end cap set, Gray
L-XANGECP-**-1	Angled end cap set, Other Colors
L-XCRVECP-GY-1	Curved end cap set, Gray
L-XCRVECP-**-1	Curved end cap set, Other Colors
L-XRECECP-GY-1	Recessed end cap set, Gray
L-XRECECP-BL-1	Recessed end cap set, Black
L-XRNDCECP-GY-1	Round end cap set, Gray
L-XRNDCECP-BL-1	Round end cap set, Black
L-XSQRECP-GY-1	Square end cap set, Gray
L-XSQRECP-**-1	Square end cap set, Other Colors

**Insert BL for Black, WH for White, B1 for Dark Brown, B2 for Tan
Flush extrusion does not take end caps.

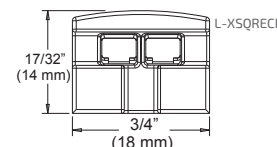
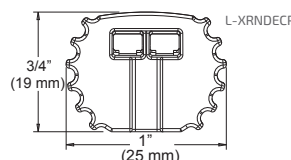
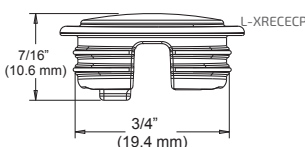

● 12/24VDC Infinex Starter Cords

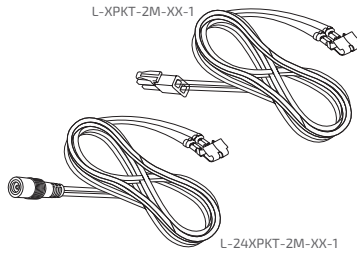

Part #	Description
L-XPKT-2M-BL-1	79" (2 m) 12VDC Infinex Starter Cord Black
L-XPKT-2IN-BL-1	2" (50 mm) 12VDC Infinex Starter Cord Black
L-XPKT-2M-WH-1	79" (2 m) 12VDC Infinex Starter Cord White
L-XPKT-2IN-WH-1	2" (50 mm) 12VDC Infinex Starter Cord White
L-24XPKT-2M-BL-1	79" (2 m) 24VDC Infinex Starter Cord Black
L-24XPKT-2M-WH-1	2" (50 mm) 24VDC Infinex Starter Cord Black

To be used with square, curved, round and angled extrusions only.

● 12/24VDC Standard FlexTape® Starter Cords

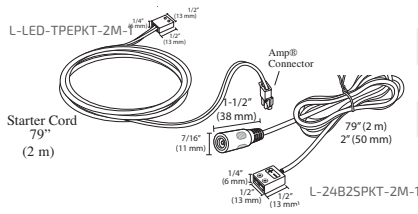

Part #	Description
L-LED-TPEPKT-2M-1	79" (2 m) 12VDC FlexTape® Straight Starter Lead
L-TPEPKT-2IN-1	2" (50 mm) 12VDC FlexTape® Straight Starter Lead
L-24B2SPKT-2M-1	2 m (29") 24VDC FlexTape® Barrel/2 Screw Trml Starter Lead, White

Recessed and Flush extrusions uses standard FlexTape® starter lead.

● U-Clips/Magnets

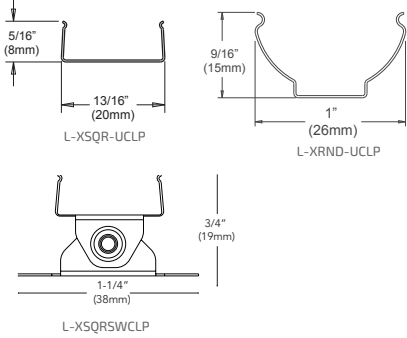

Part #	Description
L-XRND-UCLP-1	Round U-Clips Set (2 Clips)
L-XSQR-UCLP-1	Square/Curved U-Clips Set (2 Clips)
L-XSQRSWCLP-1	Square/Curved Swivel Clips Set (2 Clips)
L-XRM42-155-1	Set of 2 Magnets
L-EXTMP-VHB-1	Set of 2 Mounting Plates

One U-Clip/magnet is recommended for every 1 ft. (.3 m) of extrusion. No. #4 Phillips flat head screws are included with each U-Clip set. Mounting Plates to be used with magnet mounted Infinex.

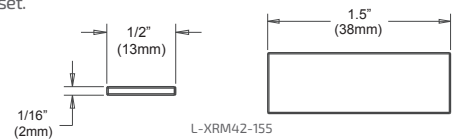

● Couplers

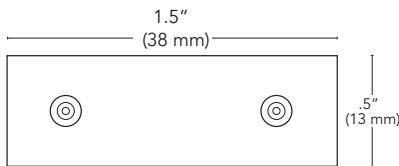

Part #	Description
L-EXTBTB10-1	Pack of 10 Couplers

To be used on square and curved extrusions only.

● 12/24VDC Linking Cords

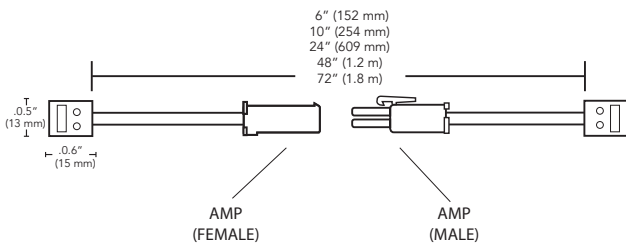

Part #	Description
L-XLKN-15-**-1	6" (15 cm) Infinex Linking Cord
L-XLKN-25-**-1	10" (25 cm) Infinex Linking Cord
L-XLKN-60-**-1	24" (60 cm) Infinex Linking Cord
L-XLKN-120-**-1	48" (120 cm) Infinex Linking Cord
L-XLKN-180-**-1	72" (180 cm) Infinex Linking Cord

** Insert BL for Black and WH for White

End Caps not used on linked extrusion ends.



COMPONENTS: POWER SUPPLIES, CONTROLLERS AND MORE SEE PAGE 141.





12VDC
24VDC

PANEL

Etch

12VDC

Etch Panels provide the perfect solution for commercial and residential backlighting and shelf lighting applications with high light output, uniform intensity and an extremely low profile between the LED panel and the illuminated material. Order it fully constructed or pre-etched panels only.

US PATENT NO: 10,113,708 and 10,473,305



Features:

Fully customized, assembled, and ready to plug-in

12VDC - 5W/ft.

Available in (5) color temperatures: 3000K, 3500K, 4000K, 5500K, and 6500K

Short lead times (4-7 days typical)*

Premium acrylic for optical clarity

Optimized Etch pattern for even illumination

*High volume orders will begin shipping within 7 days but may not ship in full

Typical Applications:

Displays

Exhibits

Signage

Store Fixtures

Countertops

Backsplashes

Modesty Panels

Shelving



Unique patented edge-lighting and LED process provides high output with even illumination



Listed in SAM Manual



Made in the USA at Tresco's manufacturing facility in Louisville, KY



Requires zero separation between the light panel and the backlit surface

Dimensions:

Acrylic Only

Fully Assembled with backer

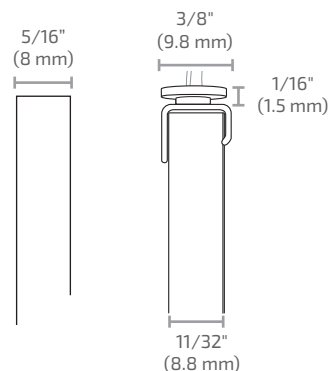

Thicknesses are subject to the industry standard of +/-10 % for acrylic

Typical Setup:
(Standard wire exit shown)

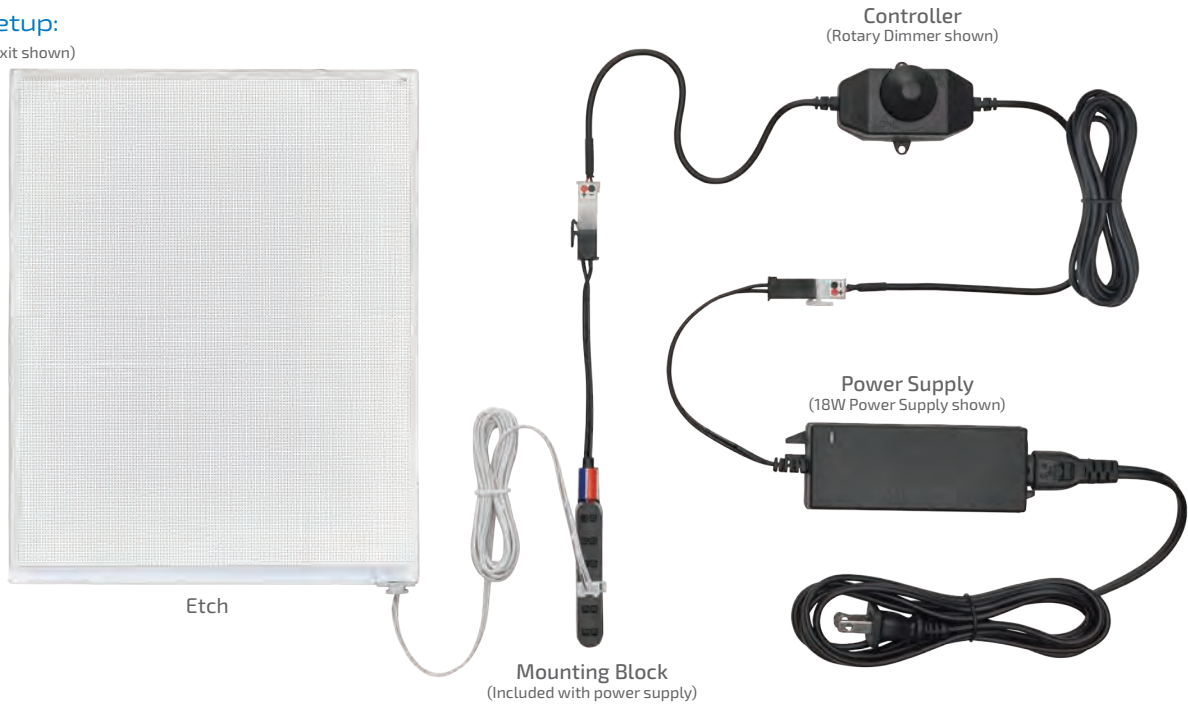

- Required
- Optional

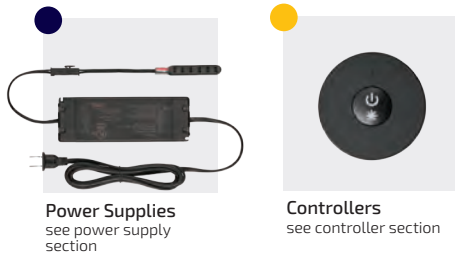

Specifications:

Wattage	Lumens	Input Voltage	Diode Life	Mounting	Minimum Size	Maximum Size	Environment	Warranty
5W/ft. (16.4W/m) Per LED populated edge of panel	100 per watt	12VDC	50,000 Hours	Surface	4" x 4" (102 mm x 102 mm)	48" x 96" (1219 mm x 2438 mm)	Dry and damp locations only	3 Year

Color Temperature

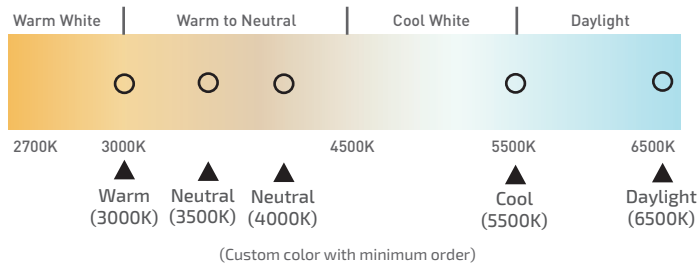

Etch

Specifications by Size

Size	LED Strip	Wattage	Wire Exits
6" x 6" (152 mm x 152 mm)	1 Edge	2.5W	1
12" x 12" (305 mm x 305 mm)	1 Edge	5W	1
24" x 24" (610 mm x 610 mm)	2 or 4 Edges	20W/40W	1
36" x 36" (915 mm x 915 mm)	2 or 4 Edges	30W/60W	2
48" x 48" (1219 mm x 1219 mm)	2 or 4 Edges	40W/80W	2
48" x 96" (1219 mm x 2438 mm)	2 Edges	60W	2

How to Select Number of LED Edges

One Edge



Panel width up to 15" (381 mm)

Two Edges

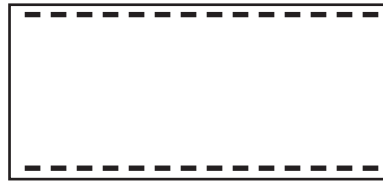

Panel width over 15" (381 mm)

All Edges

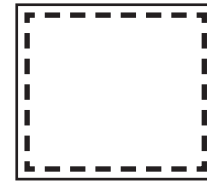

Typically used for perfect squares and larger sizes.

Typical Surface Brightness Measure

Only 10% drop in surface illuminance from edge of panel to center (based on largest panel size).

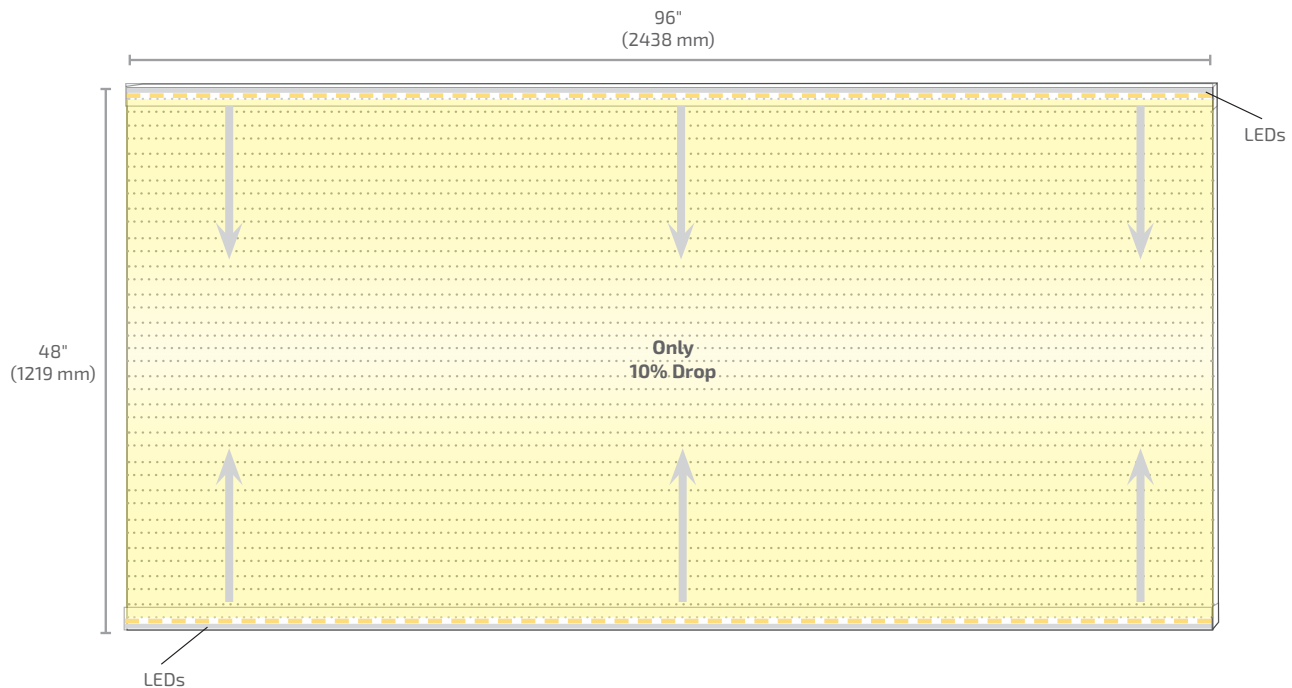

1 or 2 Sided Illumination

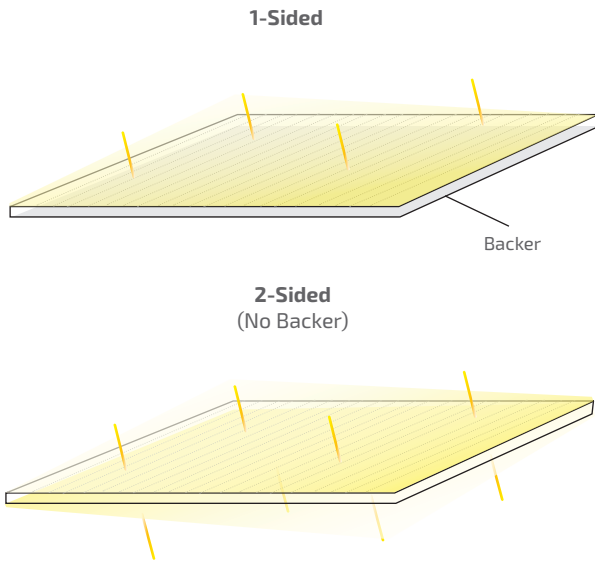

Minimize Seams When Tiling

Minimum distance to minimize seams between material and Etch panels.

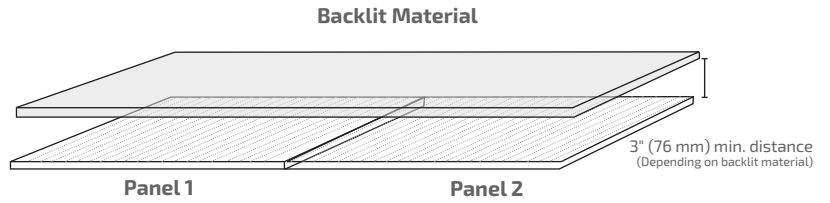

Cord Exit Options

79" (2 m) Starter cord location is customizable

LEDs will be placed on long edges unless specified as short edge on the RFQ form.

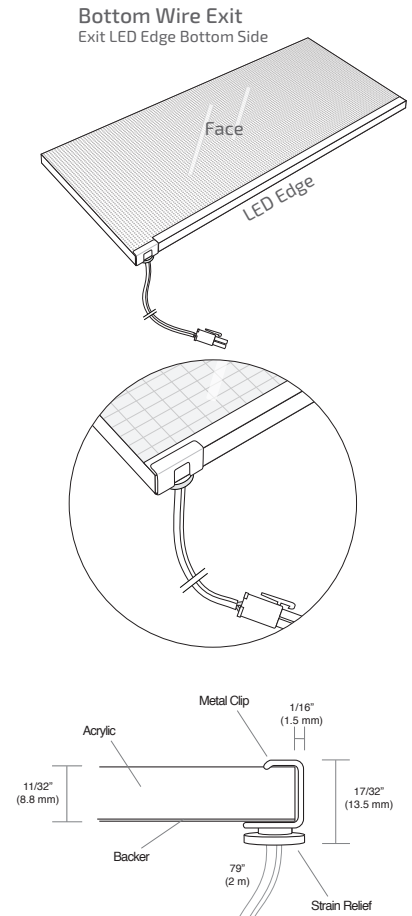
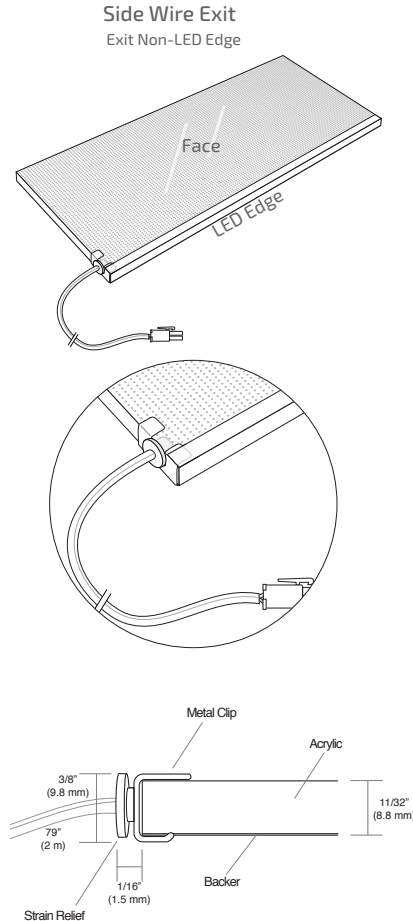
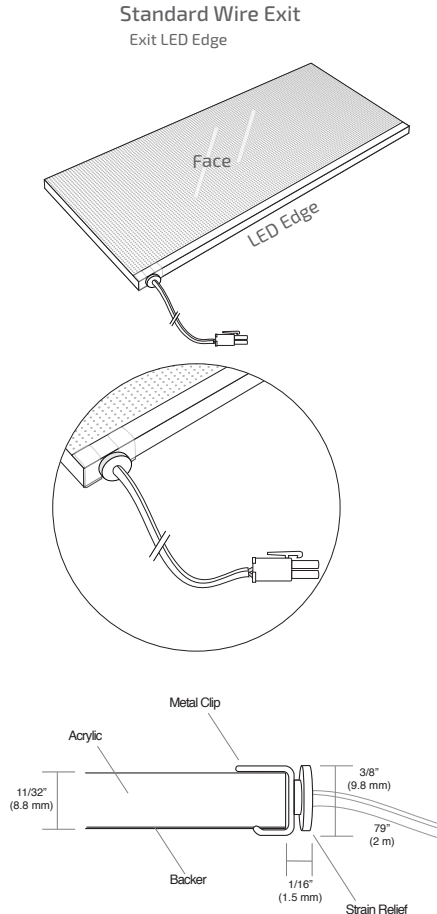

Etch

Cosmetic Tape Color

The cosmetic tape hides the LEDs and reflects light back into the panel. Cosmetic tape overlaps the face of the panel only along the LED edge. On all edges without LEDs, the cosmetic tape only runs along the edge of the panel.

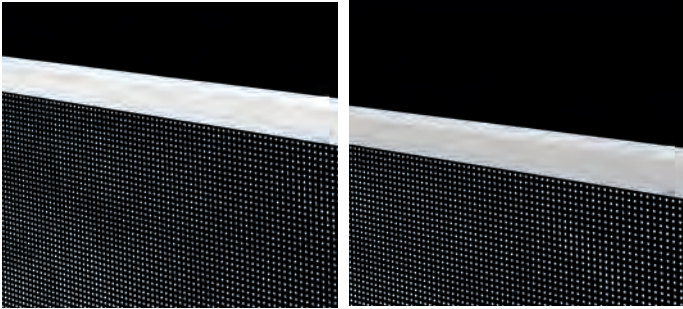

White

Silver

Flush with side

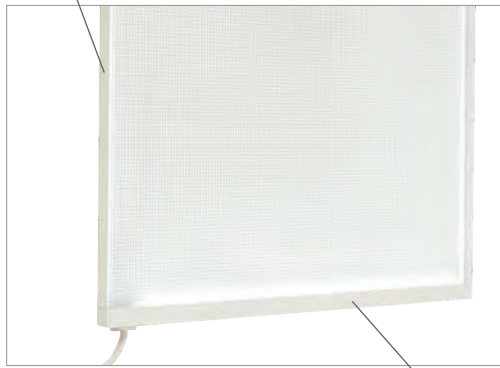

Covers LEDs on LED edge

Mounting Options

Secure panel with screws

Drilling Instructions*:

- Drill pilot holes before securing with screws
- Use the highest grit bit as possible
- Drill on flat supportive surface
- **Don't drill within 1/4" (7 mm) of edge of panel**

*Tresco Lighting is not responsible for any splintering or any other errors that may occur with drilling a panel on site.



Mounting Clips

Optional mounting clips available.

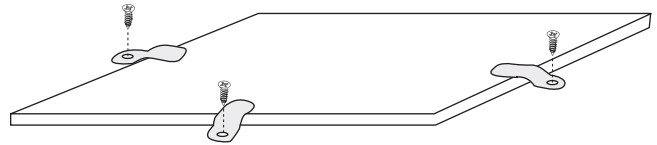

Decorative Diffusers

Decorative diffusers are an optional addition for one illuminated side of panel. They are useful for both diffusing the light emitted from the panel and for their unique aesthetic designs. Common applications are for decorative shelving and facades.

Rigid White/Milk up to 48" x 96"
(1219 mm x 2438 mm)

Decorative film up to 24" x 72" (610 mm x 1829 mm)

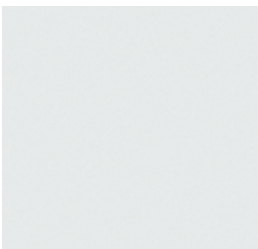

RIGID WHITE/MILK



2.5 MM HEXAGON
PATTERN

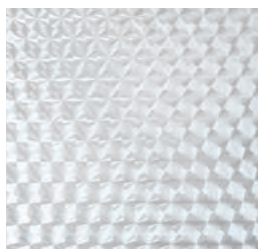

10 MM HEXAGON
PATTERN

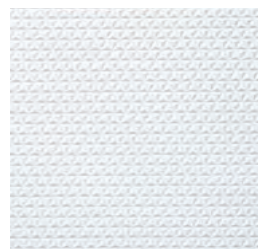

TRI-PYRAMID
PATTERN



TRIPLE WAVE
PATTERN

*Rigid diffuser available up to 48" x 96" (1219 mm x 2438 mm). Available in White/Milk only.

BUILD YOUR OWN

Choose our Build Your Own Program, featuring pre-etched acrylic panels in (4) sizes and pre-soldered LED tapes in (5) color temperatures in (4) lengths up to 96" (2438 mm), for the perfect Do-It-Yourself LED panel. Simply purchase your preferred Etch size and tape color temperature and install in your own frame.

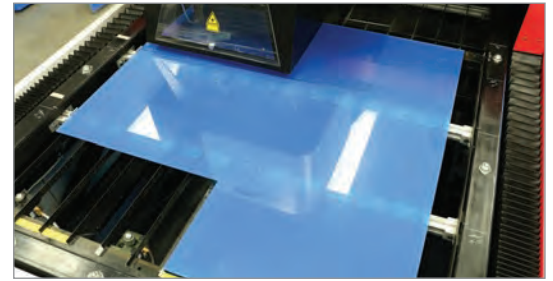
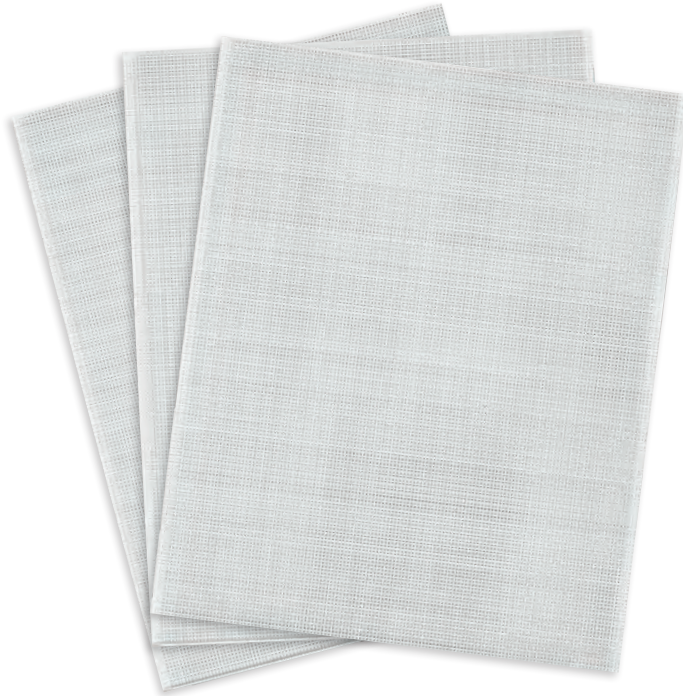

1. Buy pre-cut panels or cut-to-size

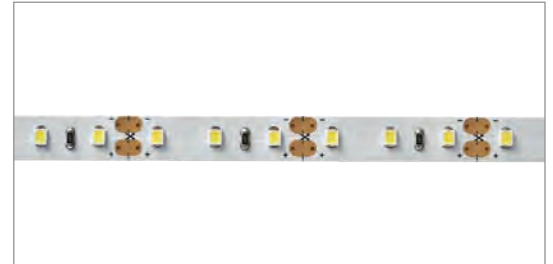

2. Buy 6 mm LED tape



3. Install in your frame

Etched Panels Only - to be cut down to size

Part #	Description
L-ACR6M-4X8-1	48" X 96" ^{**} (1219 mm x 2438 mm) 6 mm Etched Acrylic
L-ACR8M-4X8-1	48" X 96" ^{**} (1219 mm x 2438 mm) 8 mm Etched Acrylic
L-ACR6M-4X4-1	48" X 48" ^{**} (1219 mm x 1219 mm) 6 mm Etched Acrylic
L-ACR8M-4X4-1	48" X 48" ^{**} (1219 mm x 1219 mm) 8 mm Etched Acrylic
L-ACR6M-2X2-1	24" X 24" (610 mm x 610 mm) 6 mm Etched Acrylic
L-ACR8M-2X2-1	24" X 24" (610 mm x 610 mm) 8 mm Etched Acrylic
L-ACR6M-1X1-1	12" X 12" (305 mm x 305 mm) 6 mm Etched Acrylic
L-ACR8M-1X1-1	12" X 12" (305 mm x 305 mm) 8 mm Etched Acrylic

^{*}Standard dot pattern optimized for up to 24" (610 mm) width with LEDs on 2 edges
^{**}Thicknesses are subject to the industry standard of +/-10 % for acrylic

Note: Pre-etched panels are optimized for up to 24" (610 mm) with LED on (2) edges. Use (1) edge LED strip for 15" (381 mm) width and under. For widths greater than 24" (610 mm) call for custom options.

Tape LED for Pre-Etched Panels

Part #	Description
L-TPE6-12IN- ^{**} K-1	12" (305 mm) 5.5W/ft, 6 mm Pre-Soldered Tape LED w/ 79" (2 m) White input Lead
L-TPE6-24IN- ^{**} K-1	24" (610 mm) 5.5W/ft, 6 mm Pre-Soldered Tape LED w/ 79" (2 m) White input Lead
L-TPE6-48IN- ^{**} K-1	48" (1219 mm) 5.5W/ft, 6 mm Pre-Soldered Tape LED w/ 79" (2 m) White input Lead
L-TPE6-96IN- ^{**} K-1	96" (2438 mm) 5.5W/ft, 6 mm Pre-Soldered Tape LED w/ 79" (2 m) White input Lead

^{**} = color temperature (30 for 3000K, 35 for 3500K, 40 for 4000K, 55 for 5500K, 65 for 6500K)
^{*}Custom wire lead available upon request



COMPONENTS: POWER SUPPLIES, CONTROLLERS AND MORE SEE PAGE 141.

ETCH ORDERING GUIDE

We recommend ordering a kit before placing an order:

Part #	Description
L-PANELKIT-DO1	8"x10" (203 mm x 508 mm) Panel With Backer and Power Supply
L-PANELKIT-DO2	8"x10" (203 mm x 508 mm) Panel Without Backer and Power Supply

Name: _____

Company: _____

Phone: _____

Zip Code: _____

Email: _____

Distributor: _____

Project Name: _____

Project Description: _____

Estimated Quantity: _____

Date Required: _____

1 Panel Dimensions 48" x 96" (1219 mm x 2438 mm) max

If used in frame:

Length (in): _____

Channel Width (in): _____

Width (in): _____

Channel Depth (in): _____

2 LED Location

Long Edge (Standard)

Short Edge

Unsure (Tresco to specify)

3 Mounting Clips

Yes

No

4 Wire Exit

Standard

Side

Bottom

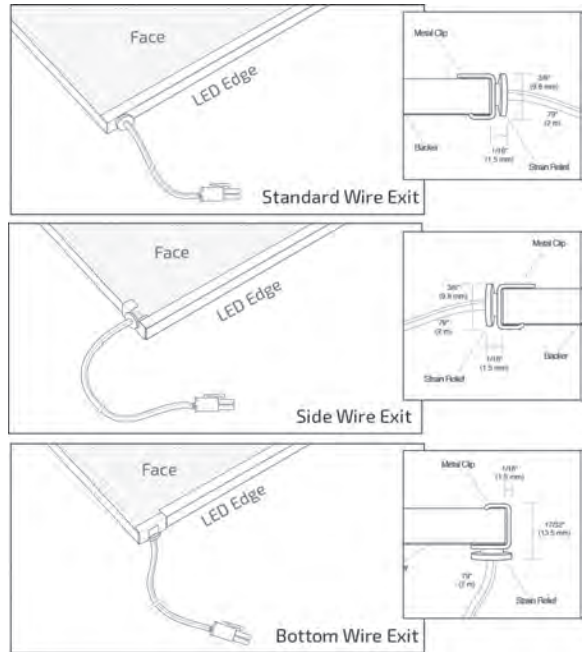

5 LED Color Temperature

3000K

3500K

4000K

5500K (Standard)

6500K

6 Backer

Yes (Single Sided Illumination)

No (Double Sided Illumination)

7 Cosmetic Tape Color

White (Standard)

Silver

8 Decorative Diffusers

Rigid White

2.5 mm Hexagon Pattern (Film)

10 mm Hexagon Pattern (Film)

Tri-Pyramid Pattern (Film)

Triple Wave Pattern (Film)

None

Film available up to 24" (610 mm) x 72 (1829 mm)"

Rigid available up to 48" (1220 mm) x 96" (2438 mm)

9 Will the panel be mounted vertically?

Yes

No

If yes, and using a rigid diffuser, the edge tape will wrap over the top of the diffuser to help secure it.

10 Special Instructions

Submit form to customquotes@trescolighting.com or fax to 502-491-2215 c/o Tresco Lighting

For online submittal:
trescolighting.com/etch-form



Snap

24VDC

Standard:
8W/ft²
High:
15W/ft²

Standard:
900 Lumens
High:
1670 Lumens



Customized lighting solutions are just a "snap" away with the Snap Panels. Sold in 12" x 12" (305 mm x 305 mm) squares, the razor-thin panels can be snapped down to 3" x 3" (76 mm x 76 mm) squares and connected back into any configuration, creating the perfect solution with complete light uniformity.

Features:

Offered in 15W/ft² (high) and 8W/ft² (standard)

24VDC System

Available in (4) color temperatures: 3000K, 4000K, 5000K and 6500K

Just 1.65 mm thick and extremely lightweight

Modular DIY system

Typical Applications:

Displays

Exhibits

Signage

Store Fixtures

Uplighting Countertops

Backsplashes (Backlighting)

Modesty Panels

Cabinets

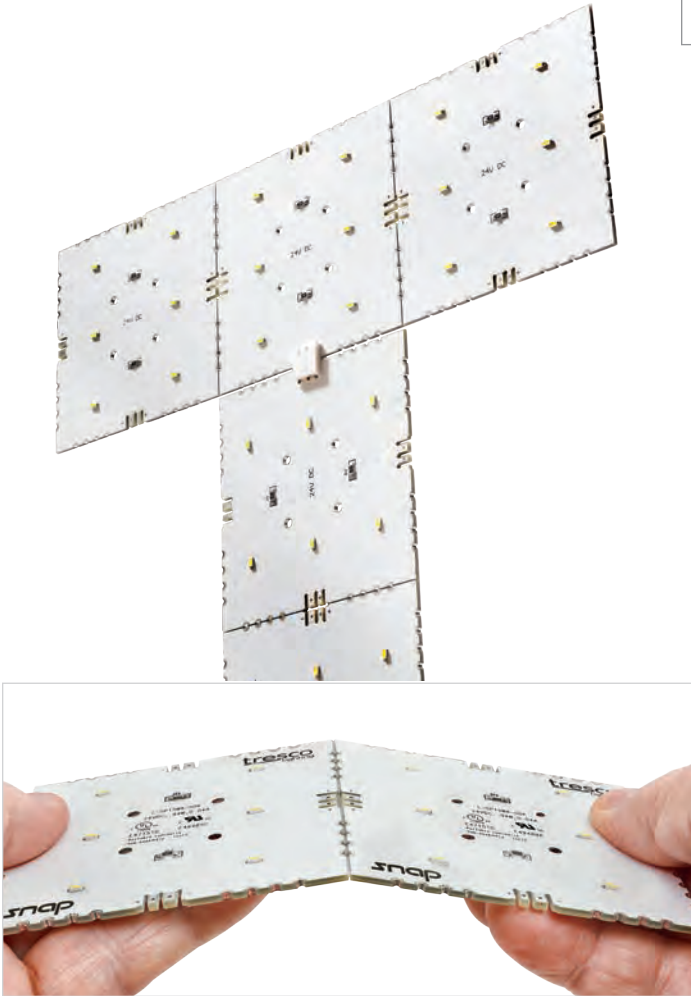

Sold as 12" x 12" (305 mm x 305 mm) panels with (16) 3" x 3" (76 mm x 76 mm) snappable squares on each panel



Great for backlighting translucent countertops



Dimensions:

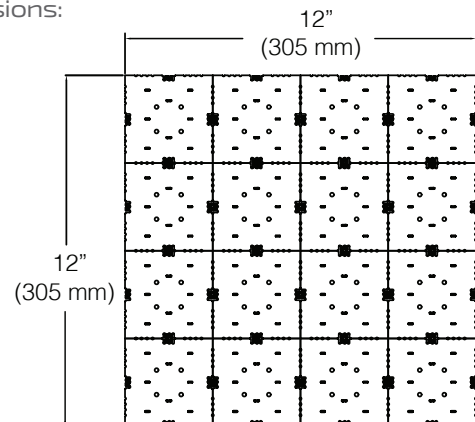

Typical Setup:



Snap

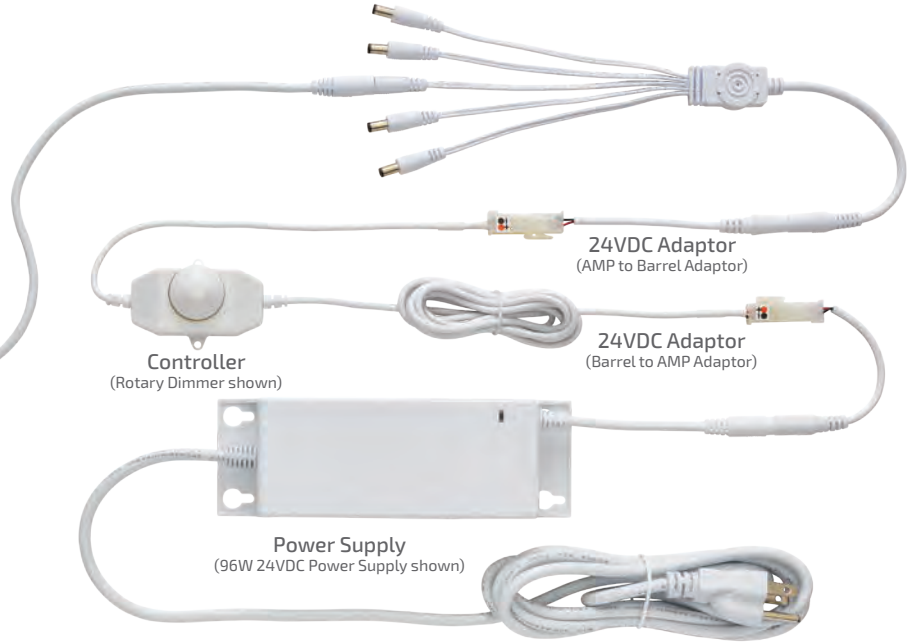

- Required
- Optional

Accessories:

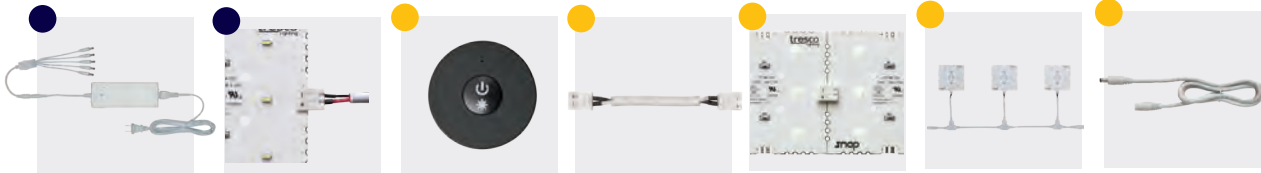

- 24VDC Power Supplies**
see power supply section
- Starter Cord**
L-SPPKT-305MM-1
L-SPPKT-1M-1
L-SPPKT-3M-1
- Controllers**
see controller section
- Snap Link Cord**
L-SPLNK8-1
L-SPLNK25-1
L-SPLNK60-1
L-SPLNK120-1
- Connectors**
L-SPBTB10-1
L-SP90BTB4-1
- Curtain Connectors**
L-SP3TCS-1
L-SP6TCS-1
- Extensions**
L-24BBEXT-1M-1
L-24BBEXT-2M-1
L-24BBEXT-3M-1

Specifications:

	Wattage	Lumens	Efficacy (lm/W)	Input Voltage	Diode Life	Max Per 96W Power Supply	Mounting	Warranty	Beam Angle
High Standard	8W/ft ² (.5W per 3" square)	900	112	24VDC	50,000 Hours	12ft ²	Surface	5 Year	
	15w/ft ² (.94W per 3" square)	1670	111			6.4ft ²			

Photometric Data

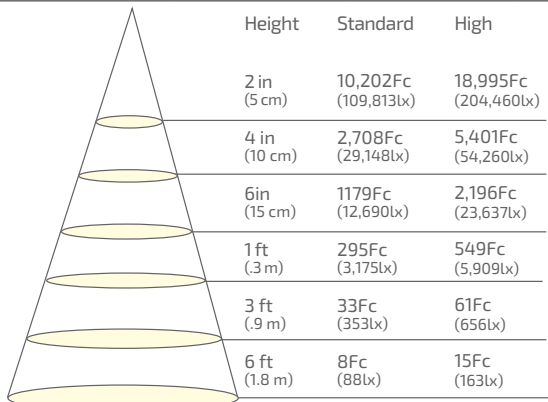

L-SP8WA-50K-1 (Standard) , L-SP15WA-50K-1 (High) Tested

Color Temperature

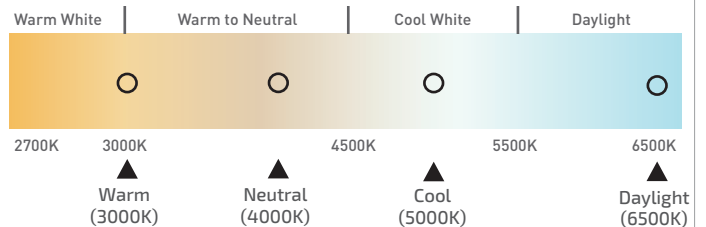

Snap

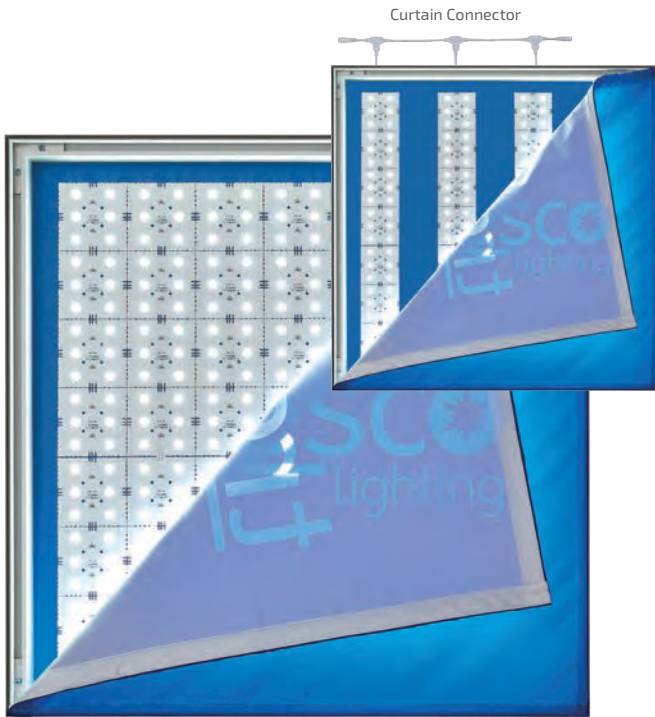

Just 2" (51 mm) of separation on average required between Snap and backlit surfaces. (8W or 15W)

OR Just 4" (102 mm) of separation required between Snap and backlit surfaces when strips are spaced 3" (76 mm) apart. (15W only)

Curtain connectors can be used to create rows (L-SP3TCS-1 and L-SP6TCS-1).

Mounting

Adhesive mount clips and screws are included with each panel for mounting purposes.



Linking

Panel squares are tileable using our simple DIY connectors (no soldering necessary)



90-Degree Back-to-Back Link



Back to Back Link
L-SPBTB10-1

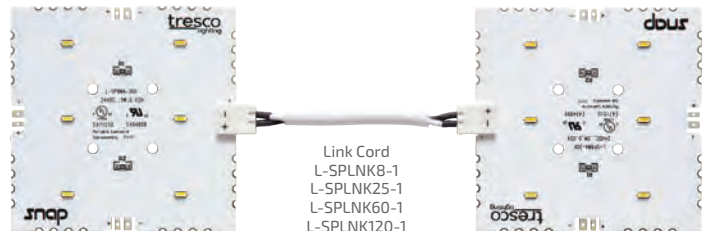

Link Cord
L-SPLNK8-1
L-SPLNK25-1
L-SPLNK60-1
L-SPLNK120-1

Applications

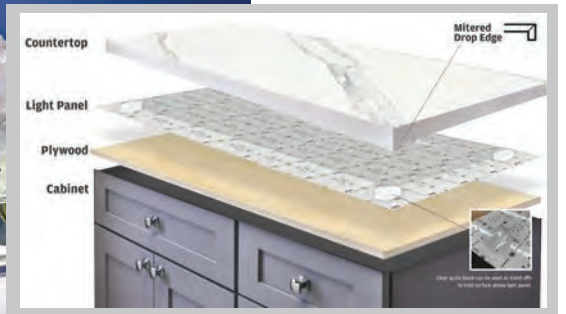

- Required
- Optional

● 24VDC Light Panel

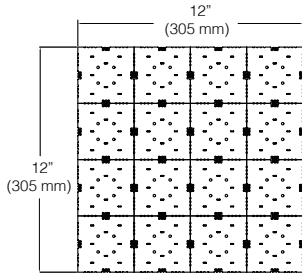

Part #	Description
L-SP8WA-30K-1	24VDC 8W 12" (305 mm) Square Snap Panel 3000K
L-SP8WA-40K-1	24VDC 8W 12" (305 mm) Square Snap Panel 4000K
L-SP8WA-50K-1	24VDC 8W 12" (305 mm) Square Snap Panel 5000K
L-SP8WA-65K-1	24VDC 8W 12" (305 mm) Square Snap Panel 6500K
L-SP15WA-30K-1	24VDC 15W 12" (305 mm) Square Snap Panel 3000K
L-SP15WA-40K-1	24VDC 15W 12" (305 mm) Square Snap Panel 4000K
L-SP15WA-50K-1	24VDC 15W 12" (305 mm) Square Snap Panel 5000K
L-SP15WA-65K-1	24VDC 15W 12" (305 mm) Square Snap Panel 6500K

Mounting clips and screws included. Starter cords sold separately.

● 24VDC Starter Cord

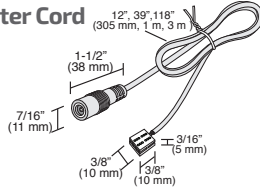

Part #	Description
L-SPPKT-305MM-1	305 mm (12") Snap Panel Starter Lead
L-SPPKT-1M-1	1 m (39") Snap Panel Starter Lead
L-SPPKT-3M-1	3 m (118") Snap Panel Starter Lead

● 24VDC Power Supplies

For details see
Power Supplies on
Page 142.

Part #	Description
L-24DCELT96-1	96W 24VDC Power Supply w/ 5 Barrel Out - White†
L-24DCELT48-BL-1	48W 24VDC Power Supply w/ 5 Barrel Out - Black†
L-24DCELT15WP-1	15W 24VDC Wall Mount Power Supply w/ Snap Connector*†
L-24DCH96X1-1	96W 24VDC Dimmable Hardwire Power Supply*§
L-24DCH96X3-1	288W 24VDC Dimmable Hardwire Power Supply*§
L-1BRL5-1	Extra 5 Output Barrel Splice

*Does not come with 5 Output Barrel Splice

†Dimmable on trailing edge (24VDC side)

§Dimmable by LED line voltage (120V) wall dimmers

● Snap Connectors

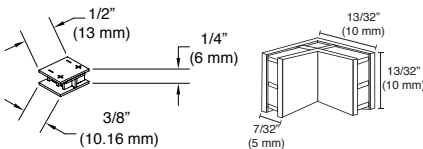

Part #	Description
L-SPBTB10-1	Snap Panel Back-to-Back Links (10 pcs)
L-SP90BTB4-1	Snap Panel 90° Back-to-Back Link (4 pcs)

● Snap Link Cord

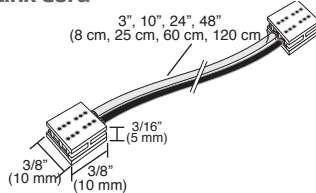

Part #	Description
L-SPLNK8-1	3" (8 cm) Snap Panel Link Cord
L-SPLNK25-1	10" (25 cm) Snap Panel Link Cord
L-SPLNK60-1	24" (60 cm) Snap Panel Link Cord
L-SPLNK120-1	48" (120 cm) Snap Panel Link Cord

● 24VDC Curtain Connectors

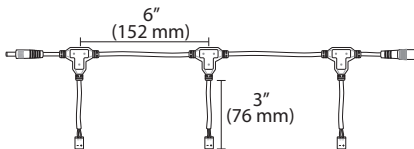

Part #	Description
L-SP3TCS-1	Three Way Curtain Starter Lead
L-SP6TCS-1	Six Way Curtain Starter Lead

● 24VDC Extension Leads

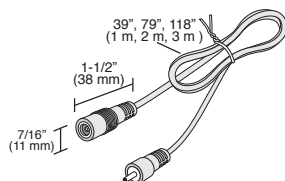

Part #	Description
L-24BBEXT-1M-1	1 M (39") 24VDC ML/FML Barrel Extension, White
L-24BBEXT-2M-1	2 M (79") 24VDC ML/FML Barrel Extension, White
L-24BBEXT-3M-1	3 M (119") 24VDC ML/FML Barrel Extension, White



12VDC

SPECIALTY



1.5W

70 Lumens



Creating a custom jewelry, museum or glass case light system has never been easier than with the Stax vertical spotlight series. Light modules and spacers snap together in seconds according to your desired configuration. Once installed, twist and pivot the modules and spotlights to aim the light exactly where needed. Build it short or stack it tall, Stax is sure to turn the ordinary into extraordinary.



Customizable system allows easy addition/removal



Light and blank modules to fit your needs

Features:

- 12VDC; High output and highly efficient at just 1.5W per LED light module
- Modules and LED lights can be twisted and positioned to almost any angle desired
- 360° horizontal and 60° vertical movement
- Stackable up to 18" (457 mm)

Typical Applications:

- Showcases
- Displays
- Museum cases
- Jewelry cases

Available Finishes:

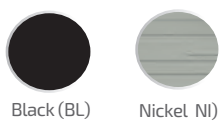

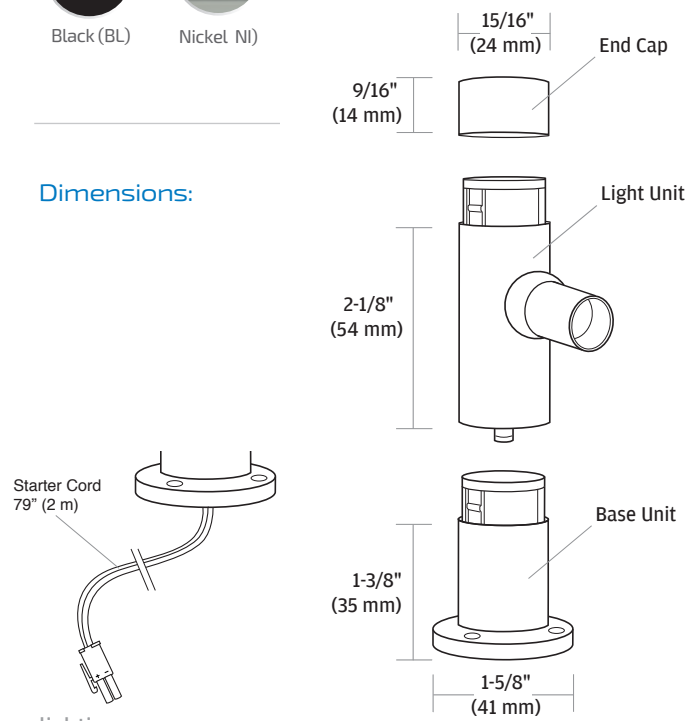

Dimensions:

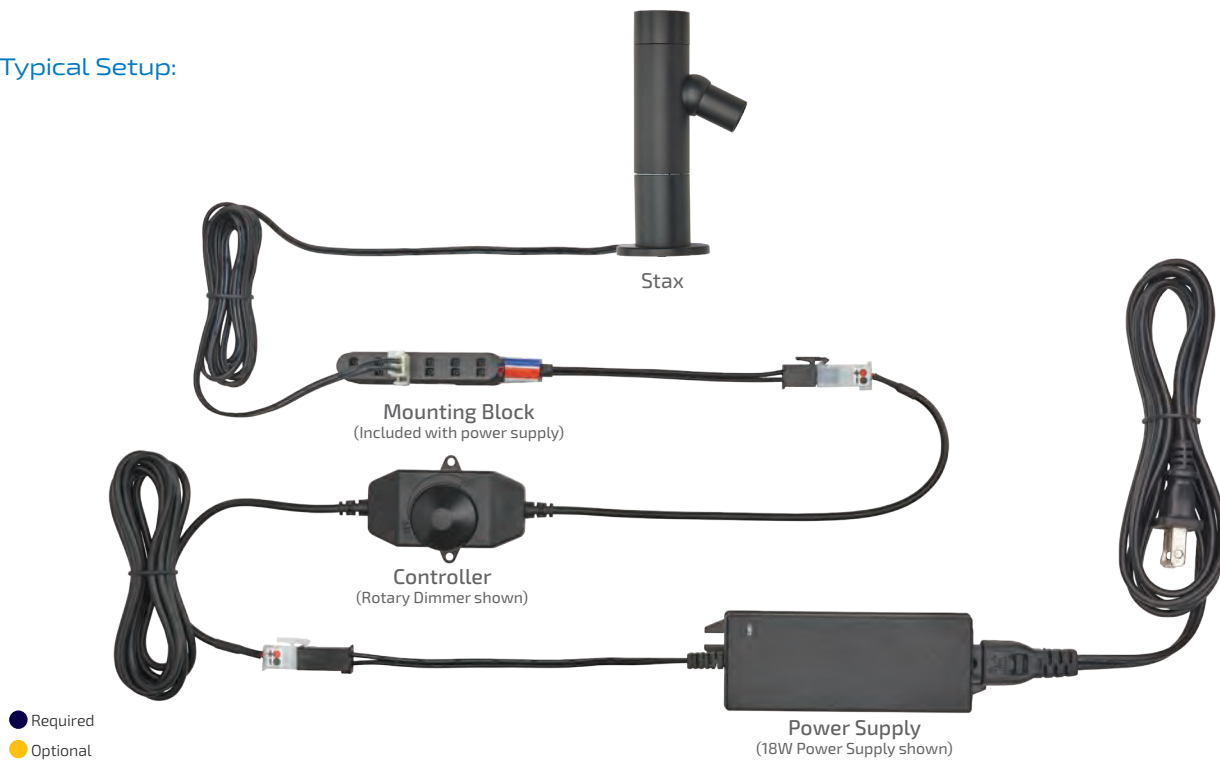

Typical Setup:



Accessories:

- Required

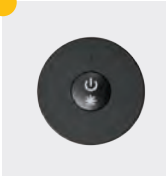
Power Supplies
 see power supply section
- Required

Stax Light Starter Kit
 L-STX-SKIT-WBL-1
 L-STX-SKIT-WNI-1
 L-STX-SKIT-CBL-1
 L-STX-SKIT-CNI-1
- Optional

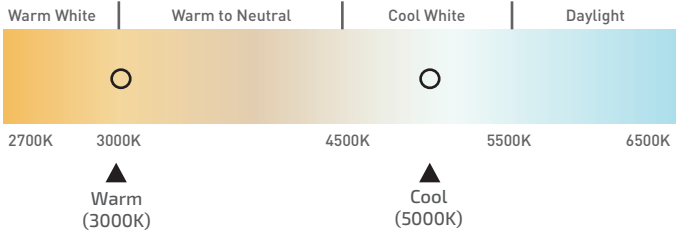
Stax Light Module
 L-STX-LITE-WBL-1
 L-STX-LITE-WNI-1
 L-STX-LITE-CBL-1
 L-STX-LITE-CNI-1
- Optional

Stax Blank Module
 L-STX-BLNK-BL-1
 L-STX-BLNK-NI-1
- Optional

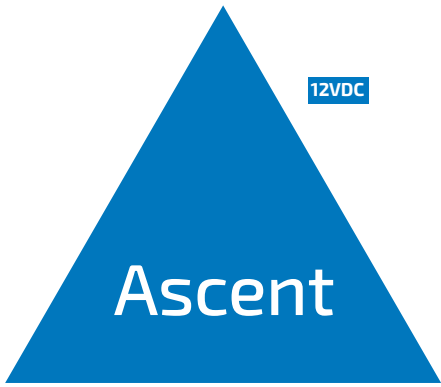
Controllers
 see controller section

Specifications:

Wattage	Lumens	Efficacy (lm/W)	Input Voltage	Diode Life	Max Per 60W Power Supply	Max Continuous Run	Mounting	Warranty	Beam Angle
1.5W per LED light module	70 per LED light module	46.7	12VDC	30,000 Hours	40 light modules	N/A	Surface	3 Year	
Color Temperature									
									

See page 139 for part numbers and descriptions



1W

41 Lumens



Let Ascent guide the way. Designed with the hotel industry in mind, it easily mounts to bed frames, nightstands, armoires and more. The featured time-adjustable PIR sensor illuminates for up to five minutes ensuring plenty of time to move about safely.

Features:

- 12VDC; 1W
- Integrated motion sensor
- Adjustable motion sensor operating time (30 seconds – 5 minutes)
- 2 mounting brackets included (90° and 116°)

Typical Applications:

- Under the bed
- Interior cabinets
- Nightstands
- Closets
- Armoires



Available Finishes:



Nickel NI



Perfect for under the bed



Motion sensor time adjustment dial



Shown with 90° Mounting bracket

Dimensions:

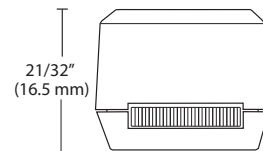
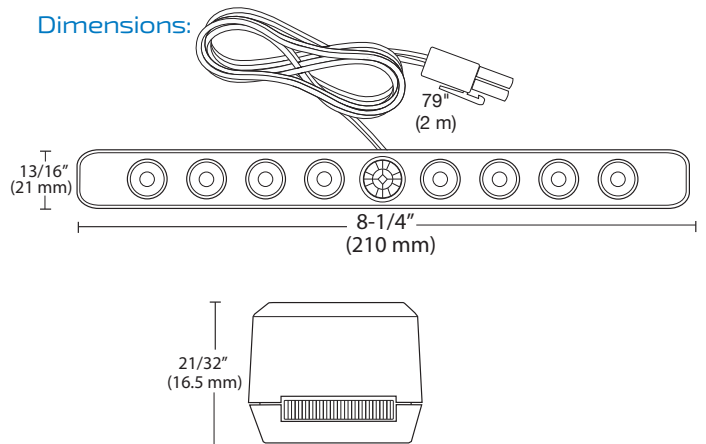

Typical Setup:

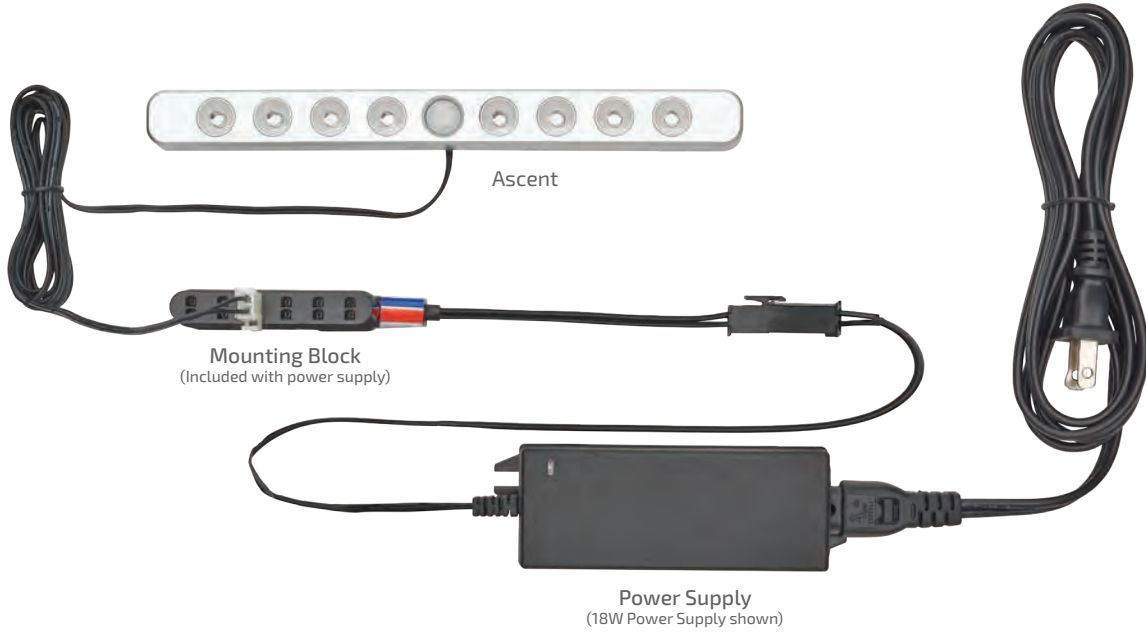

- Required
- Optional

Accessories:



Specifications:

Wattage	Lumens	Efficacy (lm/W)	Input Voltage	Diode Life	Max Per 60W Power Supply	Mounting	Warranty	Motion Detection Range	Motion Detection Angle	Beam Angle												
1W	41	41	12VDC	20,000 Hours	60 Fixtures	Surface	5 Year	79" (2 m)	110°													
Photometric Data					Color Temperature																	
<table border="1"> <thead> <tr> <th>Height</th> <th>Light Output</th> <th>Beam Area</th> </tr> </thead> <tbody> <tr> <td>1ft (.3 m)</td> <td>164.6Fc (1777.7lx)</td> <td>.3ft L x .3ft W (.09 m L x .09 m W)</td> </tr> <tr> <td>3ft (.9 m)</td> <td>18.29Fc (196.8lx)</td> <td>1ft L x 1ft W (.3 m L x .3 m W)</td> </tr> <tr> <td>6ft (1.8 m)</td> <td>4.57Fc (49.1lx)</td> <td>2ft L x 2ft W (.6 m L x .6 m W)</td> </tr> </tbody> </table> <p>L-HACNT-WNI-1 Tested</p>					Height	Light Output	Beam Area	1ft (.3 m)	164.6Fc (1777.7lx)	.3ft L x .3ft W (.09 m L x .09 m W)	3ft (.9 m)	18.29Fc (196.8lx)	1ft L x 1ft W (.3 m L x .3 m W)	6ft (1.8 m)	4.57Fc (49.1lx)	2ft L x 2ft W (.6 m L x .6 m W)	<p>Warm White Warm to Neutral Cool White Daylight</p> <p>2700K 3000K 4500K 5500K 6500K</p> <p>▲ Warm (3000K) ▲ Cool (5000K)</p>					
Height	Light Output	Beam Area																				
1ft (.3 m)	164.6Fc (1777.7lx)	.3ft L x .3ft W (.09 m L x .09 m W)																				
3ft (.9 m)	18.29Fc (196.8lx)	1ft L x 1ft W (.3 m L x .3 m W)																				
6ft (1.8 m)	4.57Fc (49.1lx)	2ft L x 2ft W (.6 m L x .6 m W)																				

See page 140 for part numbers and descriptions

12VDC Dual USB Charging Station

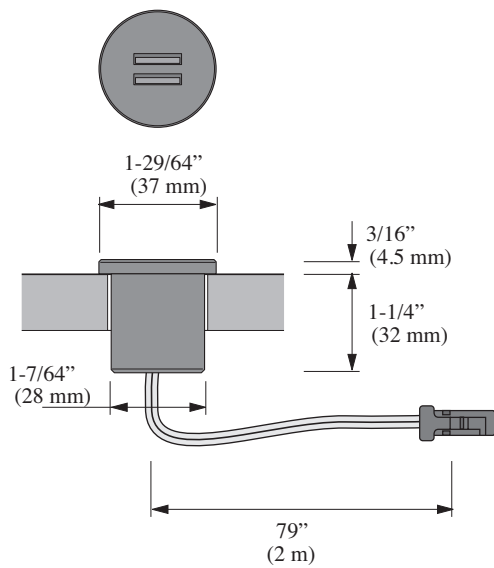

Features:

USB charging station that ties into the universal 12VDC Tresco system

79" (2 m) starter cord attached (connects to any Tresco 12VDC power supply)

Low profile recessed installation

Max. load capacity = 1 port x 2.1 Amp or 2 ports x 1.05 Amp

Two interchangeable face plates included (Black and Nickel)

Draws 10W at max capacity while charging

Has auto shut-off

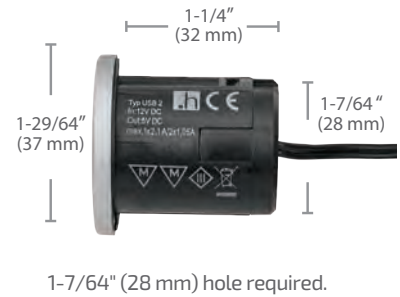

See page 140 for part numbers and descriptions

● 12VDC Stax Starter Kit

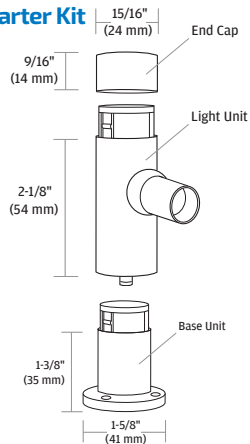

Part #	Description
L-STX-SKIT-WBL-1	Stax Starter Kit, 3000K Black
L-STX-SKIT-WNI-1	Stax Starter Kit, 3000K Nickel
L-STX-SKIT-CBL-1	Stax Starter Kit, 5000K Black
L-STX-SKIT-CNI-1	Stax Starter Kit, 5000K Nickel

Starter kit includes (1) end cap, (1) light unit module, (1) base unit. Maximum height of 18" (457 mm) or 9 blank/light modules.

● 12VDC Stax Light Module

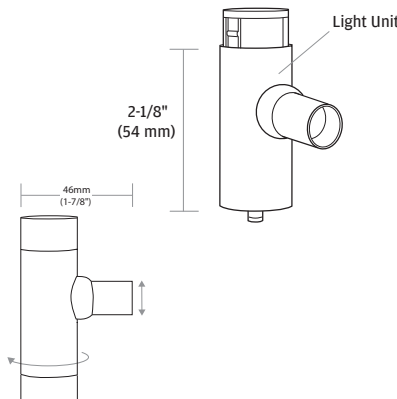

Part #	Description
L-STX-LITE-WBL-1	Stax 1.5W Light Module, 3000K Black
L-STX-LITE-WNI-1	Stax 1.5W Light Module, 3000K Nickel
L-STX-LITE-CBL-1	Stax 1.5W Light Module, 5000K Black
L-STX-LITE-CNI-1	Stax 1.5W Light Module, 5000K Nickel

Maximum height of 18" (457 mm) or 9 blank/light modules.

● 12VDC Stax Blank Module

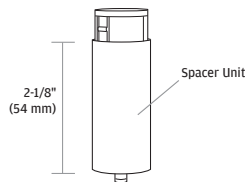

Part #	Description
L-STX-BLNK-BL-1	Stax Blank Module Black
L-STX-BLNK-NI-1	Stax Blank Module Nickel

● 12VDC Power Supplies



For details see
Power Supplies on
Page 142.

Part #	Description
L-DC-ELT18-CON-1	18W 12VDC Power Supply w/6 Snap Mounting Block*
L-DC-SLELT30-1	30W 12VDC Power Supply w/6 Snap Mounting Block*
L-DC-SLELT60-1	60W 12VDC Power Supply w/6 Snap Mounting Block*
L-DC-ELT6WP-CON-1	6W 12VDC Wall Mount Power Supply w/3 Snap Block*
L-DC-ELT15WP-CON-1	15W 12VDC Wall Mount Power Supply w/6 Snap Block*
L-DC-EQ30-1	30W 12VDC Equiline Power Supply w/6 Snap Block*
L-DC-EQ60-1	60W 12VDC Equiline Power Supply w/6 Snap Block*
L-DCE30D-CON-1	30W 12VDC Hardwire Dimmable LED Power Supply†
L-DCE60D-CON-1	60W 12VDC Hardwire Dimmable LED Power Supply†
L-12DCH60X1-1	60W 12VDC Commercial/Industrial Metal Hardwire Dimmable Power Supply§
L-12DCH60X3-1	180W 12VDC Commercial/Industrial Metal Hardwire Dimmable Power Supply§

* Dimmable on trailing edge (12VDC side). Mounting block and power cord are included.

† Dimmable by LED line voltage (120V) wall dimmers. Mounting block included.

§ Dimmable by LED line voltage (120V) wall dimmers. Mounting block not included

All hardwire power supplies require an electrician for install.



COMPONENTS: POWER SUPPLIES, CONTROLLERS AND MORE SEE PAGE 141.

- Required
- Optional

● 12VDC Ascent

Part #	Description
L-HACNT-WNI-1	12VDC 1W Ascent, 3000K, Nickel
L-HACNT-CNI-1	12VDC 1W Ascent, 5000K, Nickel

Ascent lights are not dimmable.
Includes starter cord 79" (2 m) and AMP connector with each light.

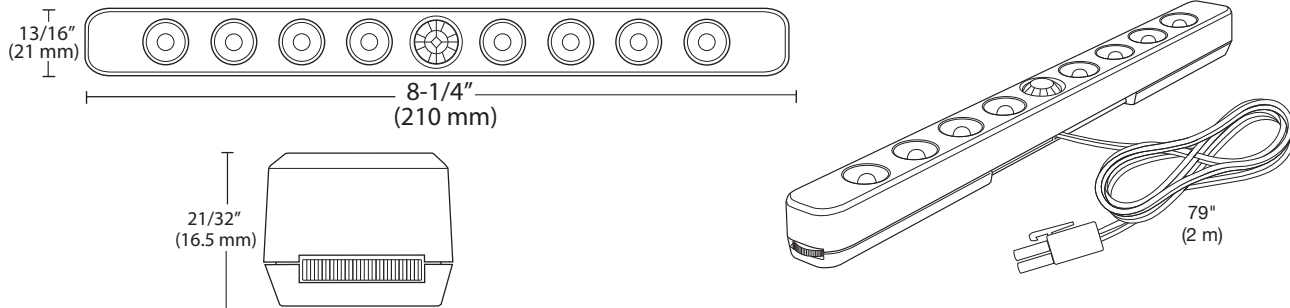

● 12VDC Power Supplies



For details see
Power Supplies on
Page 142.

Part #	Description
L-DC-ELT18-CON-1	18W 12VDC Power Supply w/6 Snap Mounting Block*
L-DC-SLELT30-1	30W 12VDC Power Supply w/6 Snap Mounting Block*
L-DC-SLELT60-1	60W 12VDC Power Supply w/6 Snap Mounting Block*
L-DC-ELT6WP-CON-1	6W 12VDC Wall Mount Power Supply w/3 Snap Block*
L-DC-ELT15WP-CON-1	15W 12VDC Wall Mount Power Supply w/6 Snap Block*
L-DC-EQ30-1	30W 12VDC Equiline Power Supply w/6 Snap Block*
L-DC-EQ60-1	60W 12VDC Equiline Power Supply w/6 Snap Block*
L-DCE30D-CON-1	30W 12VDC Hardwire Dimmable LED Power Supply†
L-DCE60D-CON-1	60W 12VDC Hardwire Dimmable LED Power Supply†
L-12DCH60X1-1	60W 12VDC Commercial/Industrial Metal Hardwire Dimmable Power Supply‡
L-12DCH60X3-1	180W 12VDC Commercial/Industrial Metal Hardwire Dimmable Power Supply‡

* Dimmable on trailing edge (12VDC side). Mounting block and power cord are included.

† Dimmable by LED line voltage (120V) wall dimmers. Mounting block included.

‡ Dimmable by LED line voltage (120V) wall dimmers. Mounting block not included
All hardwire power supplies require an electrician for install.

12VDC Dual USB Charging Station

● 12VDC Dual USB Charging Station

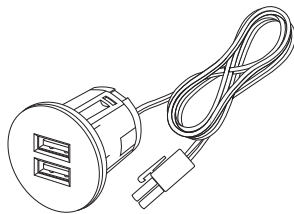

Part #	Description
L-HUSB2-BLNI-1	12VDC Dual USB Charging Station

1-7/64" (28 mm) hole required.



12VDC
24VDC
120V

COMPONENTS

Power Supplies
Controllers
Install Accessories

Power Supplies

12VDC Commercial Plug-in Power Supplies

18W 12VDC
100V - 240V

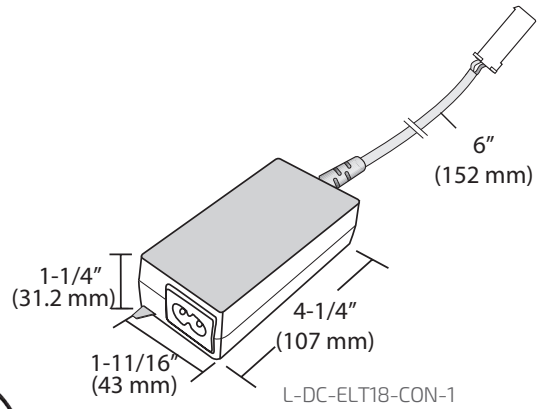

L-DC-ELT18-CON-1

Cord

Hole Size, if Needed:
5/8\"/>

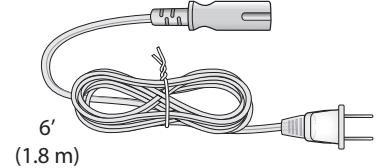

Mounting Block



Features:

12VDC constant voltage output

Short circuit protection*

Overcurrent protection

Overload protection*

RFI protection

Dimmable on trailing edge (12VDC side)

* Automatic reset (no fuses)

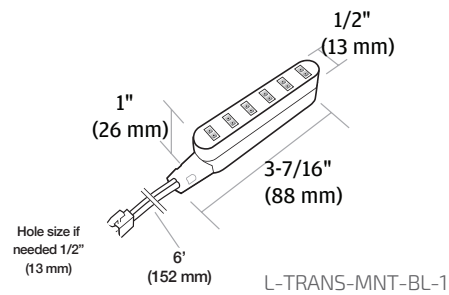

L-TRANS-MNT-BL-1

✓ Compatible with all Tresco® low voltage dimmers

✗ NOT compatible with hardwire wall dimmers

Part #	Description
L-DC-ELT18-CON-1	18W 12VDC Power Supply w/6 Snap Mounting Block
L-TRANS-MNT-BL-1	Extra 6 Snap Mounting Block

NEW!

30W 12VDC
100V - 277V

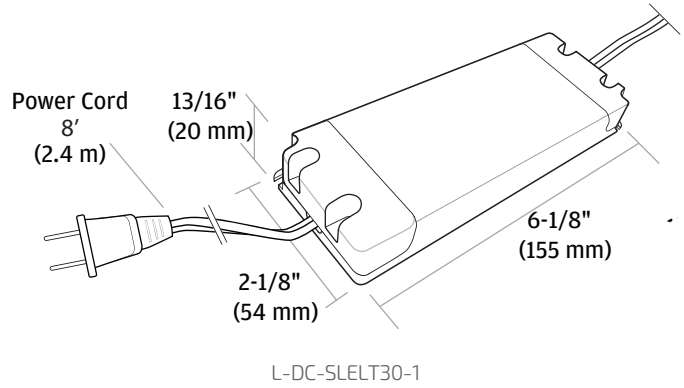

NEW!

60W 12VDC
100V - 277V

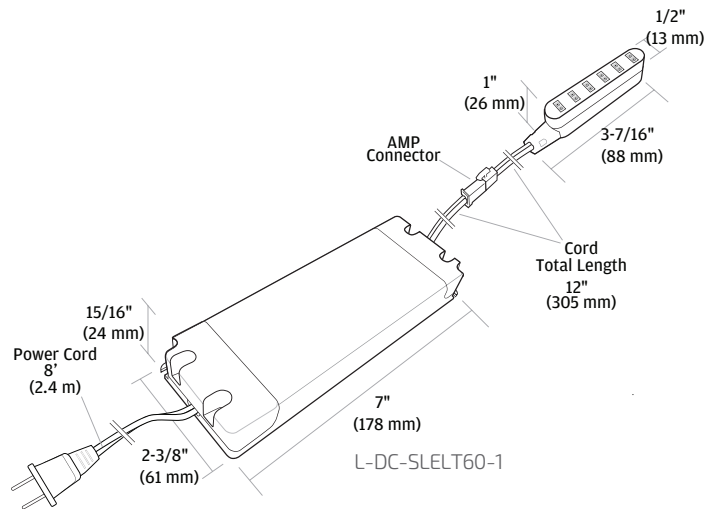

Features:

Slim design, under 1" height

(2) configurations: 30W or 60W

12VDC constant voltage output

High power factor (Pf > .95)

Short circuit protection*

Overcurrent protection

Overload protection*

RFI protection

Dimmable on trailing edge (12VDC side)

Class 2



✓ Compatible with all Tresco low voltage dimmers

⊘ NOT compatible with hardwire wall dimmers

Part #	Description
L-DC-SLELT30-1	30W 12VDC Power Supply w/6 Snap Mounting Block
L-DC-SLELT60-1	60W 12VDC Power Supply w/6 Snap Mounting Block
L-TRANS-MNT-BL-1	Extra 6-Snap Mounting Block

* Automatic reset (no fuses)

Economy Series

12VDC EquiLine Plug-in Power Supplies

6W 12VDC
100V - 240V

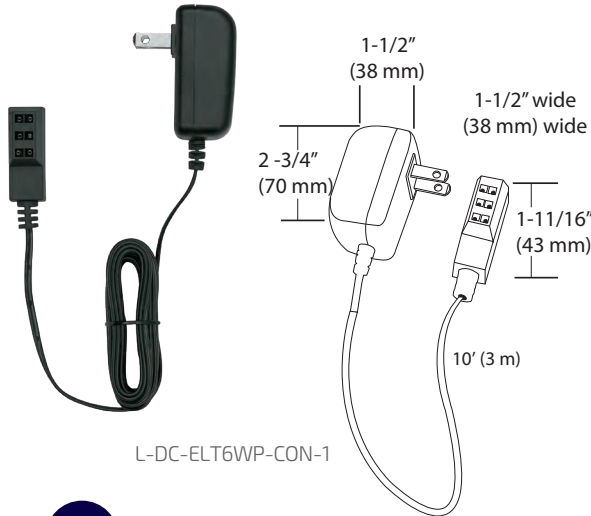

L-DC-ELT6WP-CON-1

15W 12VDC
100V - 240V

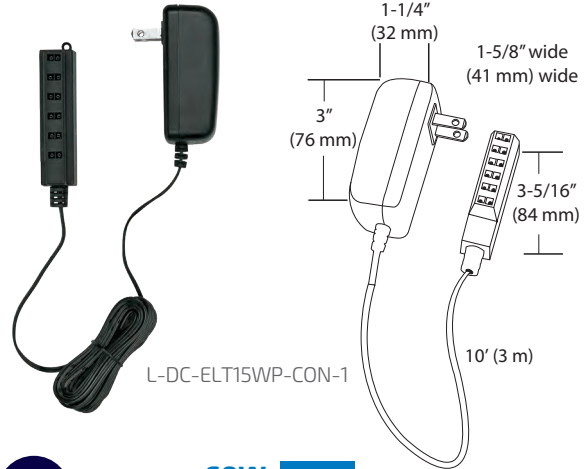

L-DC-ELT15WP-CON-1

NEW!

30W 12VDC
100V - 277V

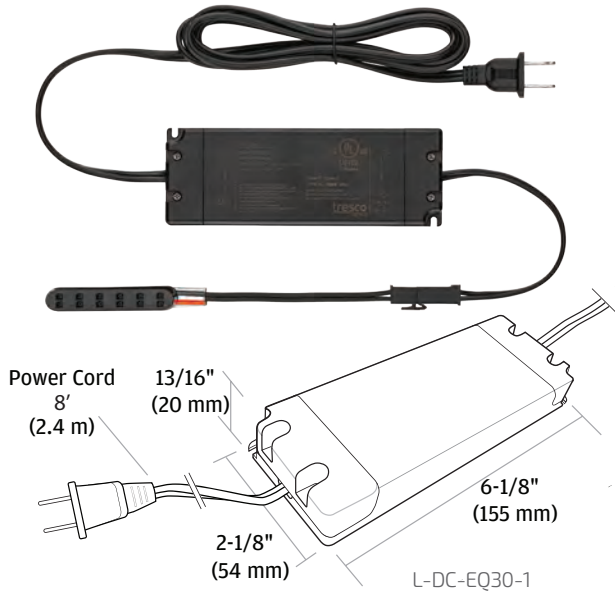

L-DC-EQ30-1

NEW!

60W 12VDC
100V - 277V

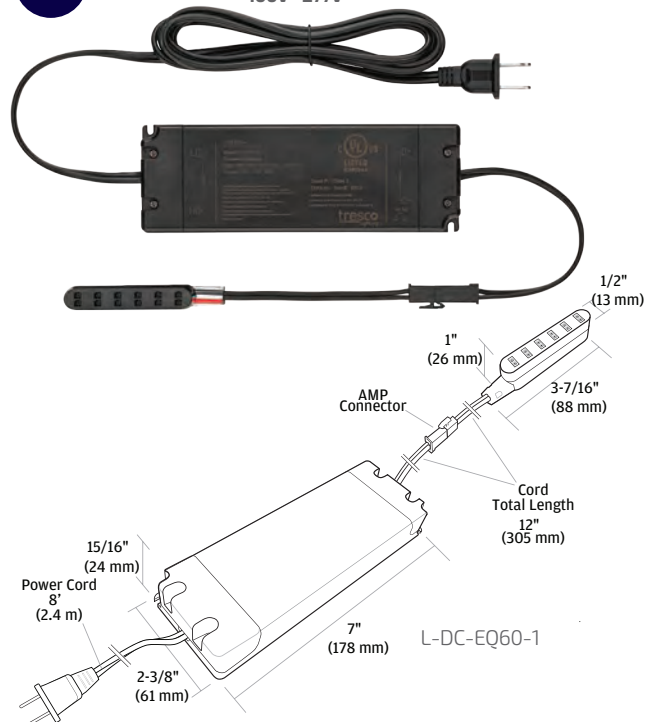

L-DC-EQ60-1



✓ Compatible with all Tresco® low voltage dimmers
 ✗ NOT compatible with hardwire wall dimmers

Part #	Description
L-DC-ELT6WP-CON-1	6W 12VDC Wall Mount Power Supply w/3 Snap Block
L-DC-ELT15WP-CON-1	15W 12VDC Wall Mount Power Supply w/6 Snap Block
L-DC-EQ30-1	30W 12VDC EquiLine Power Supply w/6 Snap Block
L-DC-EQ60-1	60W 12VDC EquiLine Power Supply w/6 Snap Block
L-TRANS-MNT-BL-1	Extra 6-Snap Mounting Block

Features:

- (4) Configurations: 6-60 Watt
- 12VDC constant voltage output
- Short circuit protection*
- Overload protection*
- RFI Protection
- Dimmable on trailing edge (12VDC side)
- Class 2
- 2-Year warranty

*Automatic Reset (no fuses)

12VDC Commercial Wall Dimmable Hardwire Power Supplies

30W 12VDC
100V - 277V



60W 12VDC
100V - 277V



Features:

- Under 1" height
- (2) configurations: 30W or 60W
- 12VDC constant voltage output
- High power factor (Pf > .95)
- Dimmable by standard LED wall dimmers
- Continuous smooth dimming
- Wire directly into unit
- Electronic units are lower profile and generate less heat than magnetic transformers
- Quiet operation
- Works with all Tresco® 12VDC dimmable LED fixtures
- One 6-snap mounting block included
- RFI Protection
- Class 2 with short circuit and automatic reset

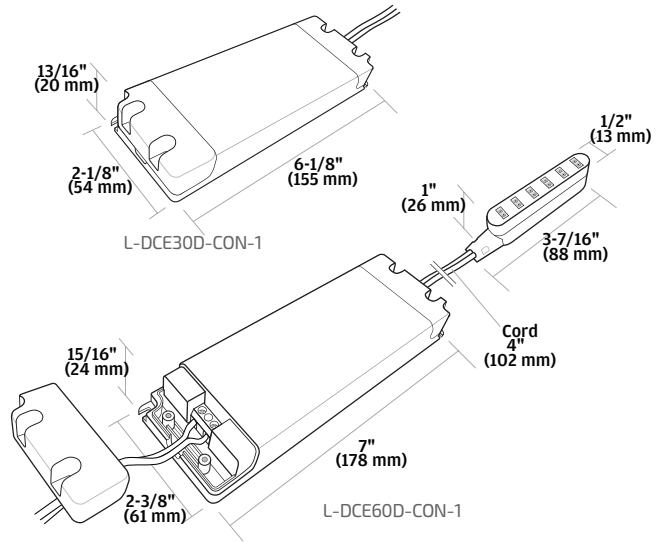

- ✓ Compatible with all Tresco® low voltage dimmers
- ✓ Compatible with hardwired LED wall dimmers

L-DCE60D-CON-1

Class 2

Part #	Description
L-DCE30D-CON-1	30W 12VDC Hardwire Dimmable LED Power Supply
L-DCE60D-CON-1	60W 12VDC Hardwire Dimmable LED Power Supply
L-TRANS-MNT-BL-1	Extra 6-Snap Mounting Block

Compatible Tresco Wall Dimmers (page 149).



Dimmable by LED compatible line voltage (120V) wall dimmers. Mounting block included. Requires electrician to install.

NEW!

12VDC Industrial Wall Dimmable Hardwire Power Supplies

(1x 60W output)

60W 12VDC
100V - 277V



(3x 60W output)

180W 12VDC
100V - 277V

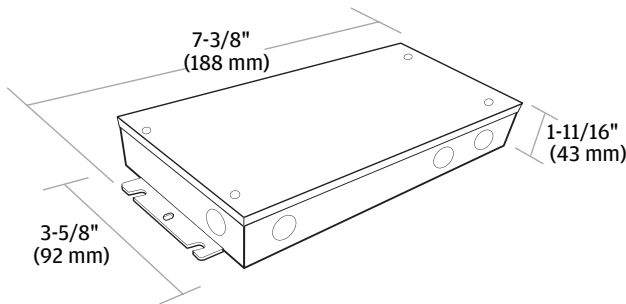

L-12DCH60X1-1

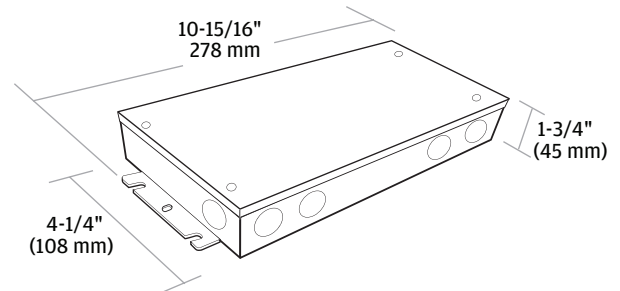

L-12DCH60X3-1



Features:

- Slim design, under 2" height
- (2) configurations: 60W or 180W
- 12VDC constant voltage output
- High power factor (Pf > .95)
- Built-in hardwire compartment
- All metal construction
- Short circuit protection*
- Overcurrent protection
- Overload protection*
- RFI protection
- Dimmable by standard LED wall dimmers
- Class 2

- ✓ Compatible with all Tresco® low voltage dimmers
- ✓ Compatible with hardwired LED wall dimmers

* Automatic reset (no fuses)

Part #	Description
L-12DCH60X1-1*	60W 12VDC Commercial/Industrial Metal Hardwire Dimmable Power Supply
L-12DCH60X3-1*	180W 12VDC Commercial/Industrial Metal Hardwire Dimmable Power Supply
L-TRANS-MNT-BL-1	Extra 6-Snap Mounting Block

* Does not include 6-snap mounting block
Dimmable by LED line voltage (120V) wall dimmers. Mounting block not included
Requires electrician to install.

Compatible Tresco Wall Dimmers (page 149).



24VDC Commercial Plug-in Power Supplies

NEW!

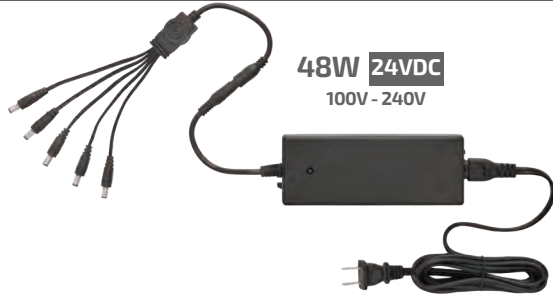

48W 24VDC
100V - 240V

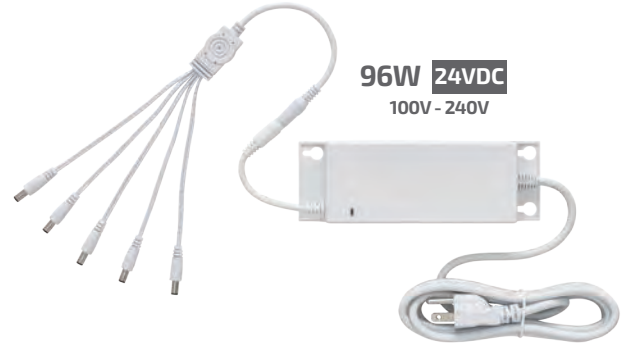
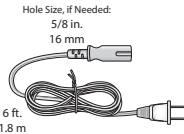

96W 24VDC
100V - 240V

Class 2

Features:

- Slim design, under 1.6" height
- 24VDC constant voltage output
- High power factor (Pf > .95) **96W only**
- (5) barrel output (included)
- Short circuit protection*
- Overcurrent protection
- Overload protection*
- RFI protection
- Dimmable on trailing edge (24VDC side)
- Class 2
- * Automatic reset (no fuses)

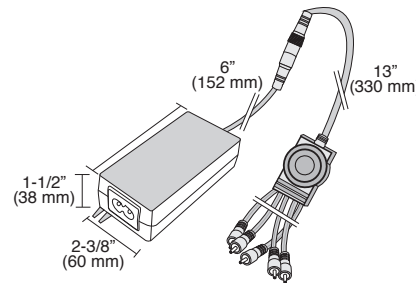

L-24DCELT48-BL-1

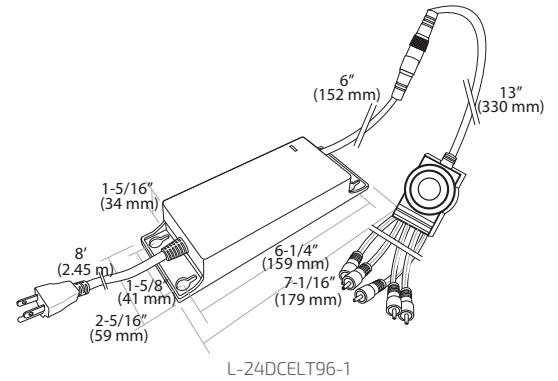

L-24DCELT96-1

Compatible with all Tresco low voltage dimmers
 NOT compatible with hardwire wall dimmers

Part #	Description
L-24DCELT48-BL-1	48W 24VDC Power Supply w/ 5 Barrel Out - Black
L-24DCELT96-1	96W 24VDC Power Supply w/ 5 Barrel Out - White
L-1BRL5-1	Extra 5 Output Barrel Splice

Economy Series

24VDC EquiLine Plug-in Power Supply

NEW!

15W 24VDC
100V - 240V

Features:

- 24VDC constant voltage output
- Fully enclosed wall mount plastic case
- Single barrel connector output
- Short circuit protection*
- Overcurrent protection
- Overload protection*
- RFI protection
- Dimmable on trailing edge (24VDC side)
- Class 2
- 2-Year warranty

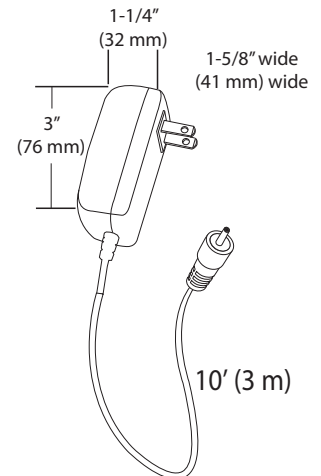

*Automatic Reset (no fuses)

Class 2

Part #	Description
L-24DCELT15WP-1	15W 24VDC Wall Mount Power Supply w/ barrel connector
L-1BRL5-1	Extra 5 Output Barrel Splice

Compatible with all Tresco low voltage dimmers
 NOT compatible with hardwire wall dimmers

NEW!

24VDC Industrial Wall Dimmable Hardwire Power Supplies

(1x 96W output)

96W 24VDC
100V - 277V

(3x 96W output)

288W 24VDC
100V - 277V

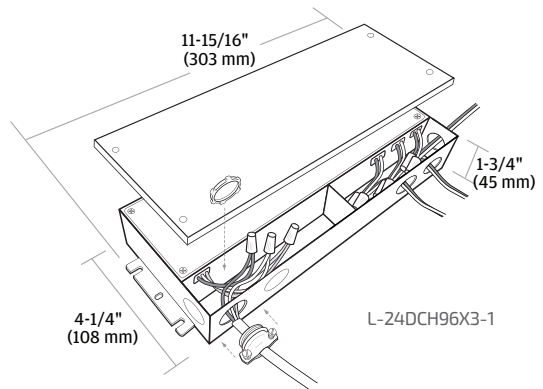
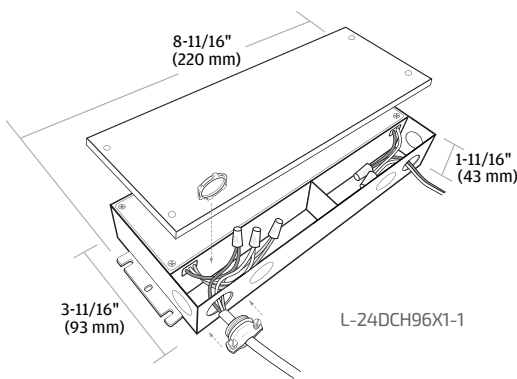

Features:

- Slim design, under 2" height
- 24VDC constant voltage output
- High power factor (PF>.95)
- Built-in hardwire compartment
- All metal construction
- Short circuit protection*
- Overcurrent protection
- Overload protection*
- RFI protection
- Dimmable by standard LED wall dimmers
- Class 2
- * Automatic reset (no fuses)



- ✓ Compatible with all Tresco® low voltage dimmers
- ✓ Compatible with hardwired LED wall dimmers

Part #	Description
L-24DCH96X1-1*	24VDC 96W Commercial/Industrial Metal Hardwire Dimmable Power Supply
L-24DCH96X3-1*	24VDC 288W Commercial/Industrial Metal Hardwire Dimmable Power Supply
L-1BRLS-1	Extra 5 Output Barrel Splice

*Does not include 5 Output Barrel.
Dimmable by LED line voltage (120V) wall dimmers.
Mounting block not included
Requires electrician to install.

Compatible Tresco Wall Dimmers (page 149).



120V LED Wall Dimmers

120V

Lutron Diva® C-L™ Dimmer

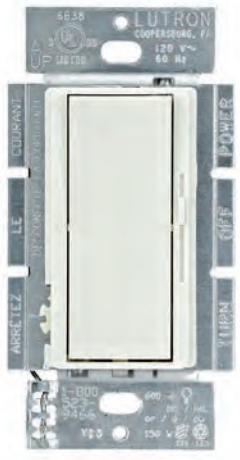

150W

Lutron Skylark Contour C-L™ Dimmer



150W

Leviton Decora® 300W LED Dimmer



300W

Lutron Diva® C-L™ Dimmer 150W

- Large paddle switch with a captive linear-slide dimmer for a standard designer wall plate opening
- Switch returns light to preset light level
- Offers more reliable dimming performance over standard dimmers
- HED™ technology with advanced dimming circuitry designed for compatibility with most high-efficiency light bulbs
- Adjustment switch to modify the minimum light level in order to maximize the dimming range if flickering occurs at lower dimming levels

Lutron Skylark Contour C-L™ Dimmer 150W

- On/off rocker switch with a captive linear-slide dimmer for a standard designer wallplate opening
- Switch returns light to preset light level
- Offers more reliable dimming performance over standard dimmers
- HED™ technology with advanced dimming circuitry designed for compatibility with most high-efficiency light bulbs
- Low-end adjustment dial

Leviton Decora® 300W

- Large paddle switch with a captive linear-slide dimmer for a standard designer wall plate opening
- Packaged with White, Ivory, and Light Almond color change kits
- Switch returns light to preset light level
- No neutral wire required for installation
- Adjustment switch to modify the minimum light level in order to maximize the dimming range if flickering occurs at lower dimming levels

Part #	Description
L-DVCL-153P-WH-1	Lutron Diva® 150W C-L™ Dimmer w/out plate
L-CTCL-153P-WH-1	Lutron Skylark Contour C-L™ 150W Dimmer w/out plate
L-DSL06-1LZ-1	Leviton® Decora® 300W LED Dimmer w/WH-IV-LA Kit

Compatible with Tresco 12VDC and 24VDC Wall Dimmable Power Supplies (previous pages)

Controllers

Single color control

FREEDiM

WIRELESS CONTROL



FREEDiM Series Universal Receiver

12VDC
24VDC

Features:

60W Capacity (12VDC); 96W Capacity (24VDC)

- Power failure memory
- Multiple receivers can be used in a single power supply or within a room to achieve multiple zones of control
- Simple one button pairing with dimmers

Compatible with all single color FREEDiM Series controllers



Deco Wall Dimmers

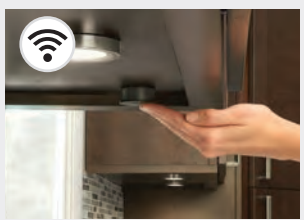

Mirco Dimmers

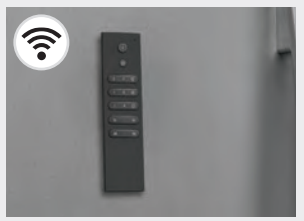

3 Zone Remote

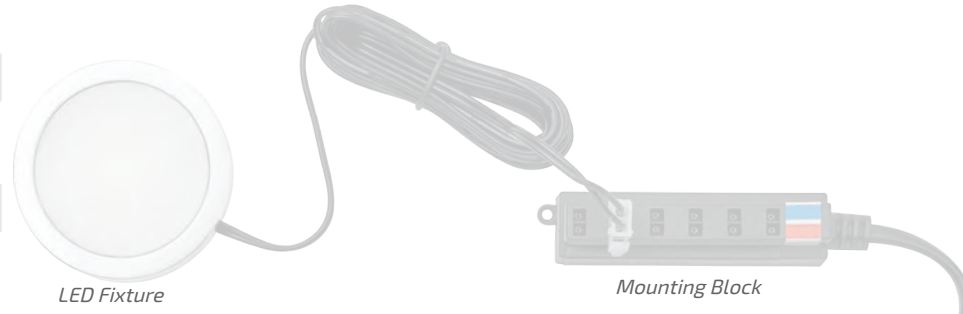

LED Fixture

Mounting Block



Universal FREEDiM Series Receiver
L-WLD-1REC-1

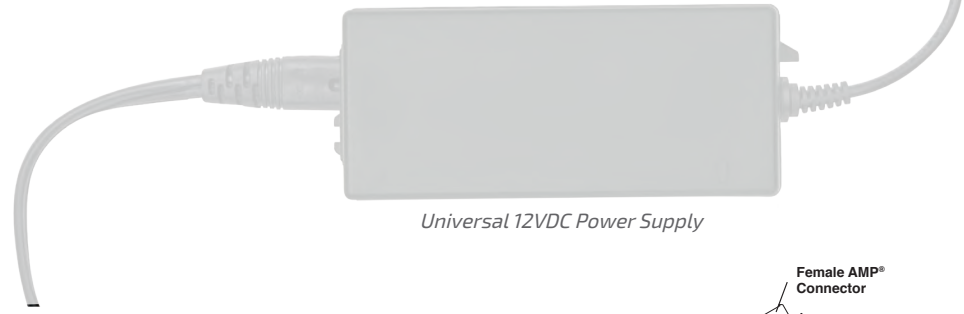

Universal 12VDC Power Supply

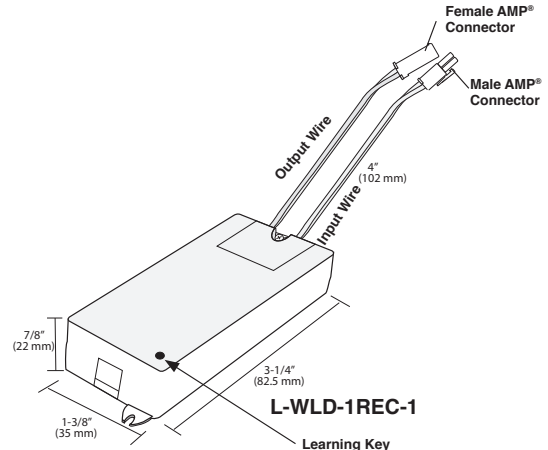

Part #	Description
L-WLD-1REC-1	12/24VDC FREEDiM Series Receiver

A single receiver can be programmed to up to 8 different FREEDiM Series remotes/dimmers

All product dimensions and specifications are subject to change without prior notice.

Single Color Controllers

PATENT NO. 9,818,559 B2

FREEDiM Series Deco Wall Dimmer

Features:

Available in single and 2-zone

Can be programmed to multiple receivers for more lighting control

Black, white, or light almond finish

Fits Decora® style wall plates

65 ft. range of control from dimmer to receiver

Controls all Tresco® 12/24VDC dimmable low voltage lights

Unlike traditional hardwire dimmers, you can control the same set of lights from multiple Deco Wall Dimmers

FREEDiM

WIRELESS CONTROL

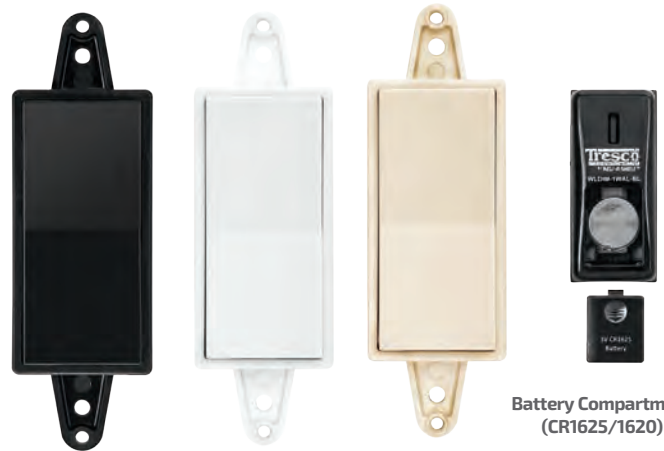

Battery Compartment (CR1625/1620)



Easily remove switch from docking tray to replace batteries or use as a remote dimmer

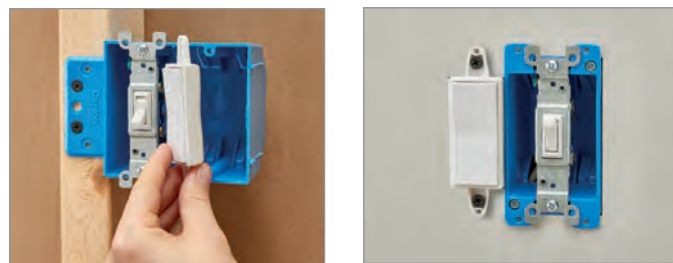

Can be mounted to standard wall electrical boxes or to drywall

Also available in 2-Zone:

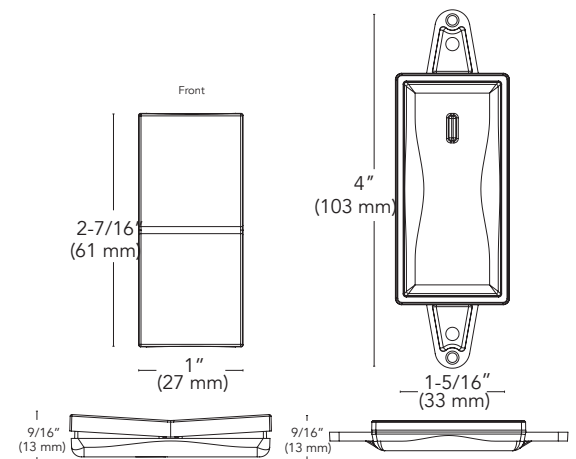
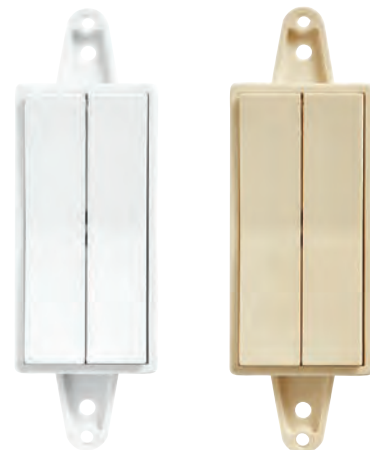

Part #	Description
L-WLD-1WAL-**-1	FREEDiM Series Deco Wall Dimmer
L-WLD-2WAL-**-1	FREEDiM Series Two-Zone Deco Wall Dimmer
L-WLD-1REC-1	12/24VDC FREEDiM Series Receiver

**Insert BL for Black (only available in single zone), WH for White, LA for Light Almond

A single dimmer can be programmed to up to 10 different receivers.

Must have at least one receiver (L-WLD-1REC-1) to operate

A single receiver can be programmed to up to 8 different FREEDiM Series remotes/dimmers

FREEDiM Series Wireless Controllers



FREEDiM Series Micro Dimmer

Features:

Single zone wireless dimmer

Black or Nickel finish

Easy to replace, long life lithium battery

65 ft. (20 m) range of control from dimmer to receiver

Controls all Tresco® 12VDC/24VDC dimmable low voltage lights

Recess or surface mount



Integrated Magnet

Battery Compartment (CR2025)

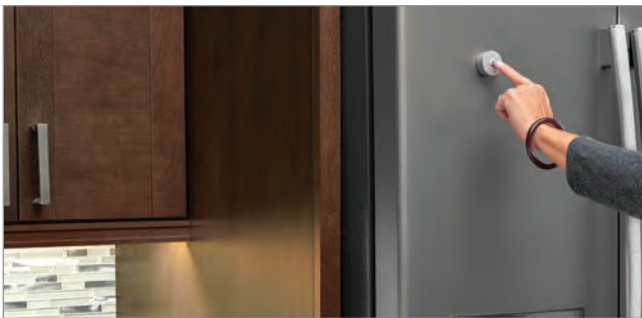

Integrated magnet allows for mounting to refrigerator or other metallic surfaces



Easy 2 screw installation

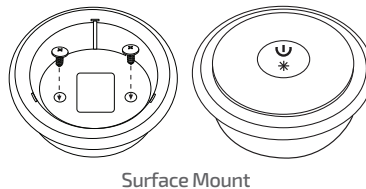
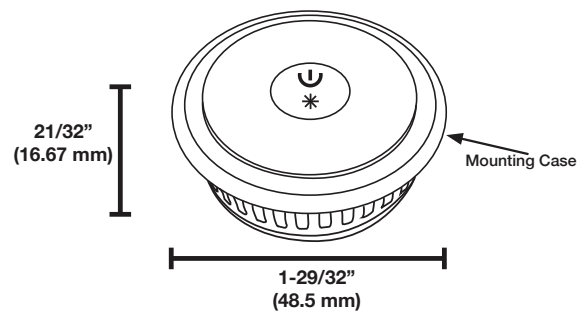

Surface Mount

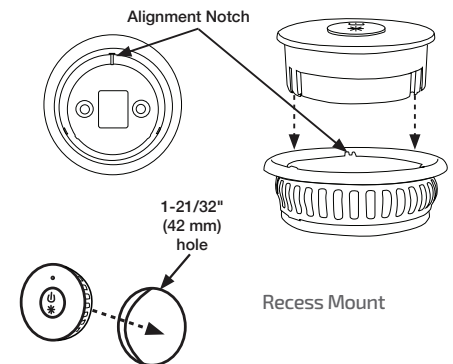

Recess Mount

Part #	Description
L-WLD-1RND-BL-1	FREEDiM Series Micro Dimmer, Black
L-WLD-1RND-NI-1	FREEDiM Series Micro Dimmer, Nickel
L-WLD-1REC-1	12/24VDC FREEDiM Series Receiver

A single dimmer can be programmed to up to 10 different receivers.
Must have at least one receiver (L-WLD-1REC-1) to operate

A single receiver can be programmed to up to 8 different FREEDiM Series remotes/dimmers
 Must purchase 12VDC to 24VDC Controller Adaptor Cord Set for 24VDC LED fixtures.

FREEDiM Series 3 Zone Remote

Features:

Independent control of 3 lighting zones from single remote

Program additional receivers to separate the lighting in a room into multiple zones that you can control independently

Set brightness levels of all of the zones to a desired level then save as a "scene"

65 ft. (20 m) range of control from remote to receiver

Controls all Tresco® 12/24VDC dimmable low voltage lights



Integrated magnet allows for mounting to refrigerator or other metallic surfaces.



Docking tray can be screw mounted. Remotes attach to tray magnetically.

FREEDiM
WIRELESS CONTROL



3-Zone
(CR2032 Battery)



Battery Compartment
(CR2032 Battery)

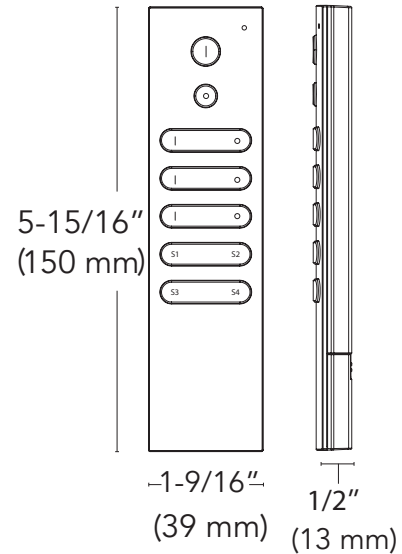

Part #	Description
L-WLD-3RMT-BL-1	FREEDiM Series 3-Zone remote, Black
L-WLD-1REC-1	12/24VDC FREEDiM Series Receiver

Must have at least one receiver (L-WLD-1REC-1) to operate

A single receiver can be programmed to up to 8 different FREEDiM Series remotes/dimmers

NEW!

Wireless Door Sensor Receiver

12VDC
24VDC

FREEDiM
WIRELESS CONTROL

Features:

- 60W capacity (12VDC); 96W capacity (24VDC)
- Power failure memory
- Install inline between power supply and lights
- Simple one button pairing with Wireless Door Sensors
- Single receiver can be programmed with up to (4) sensors
(Allows for up to 4 doors to control the same light fixtures.)

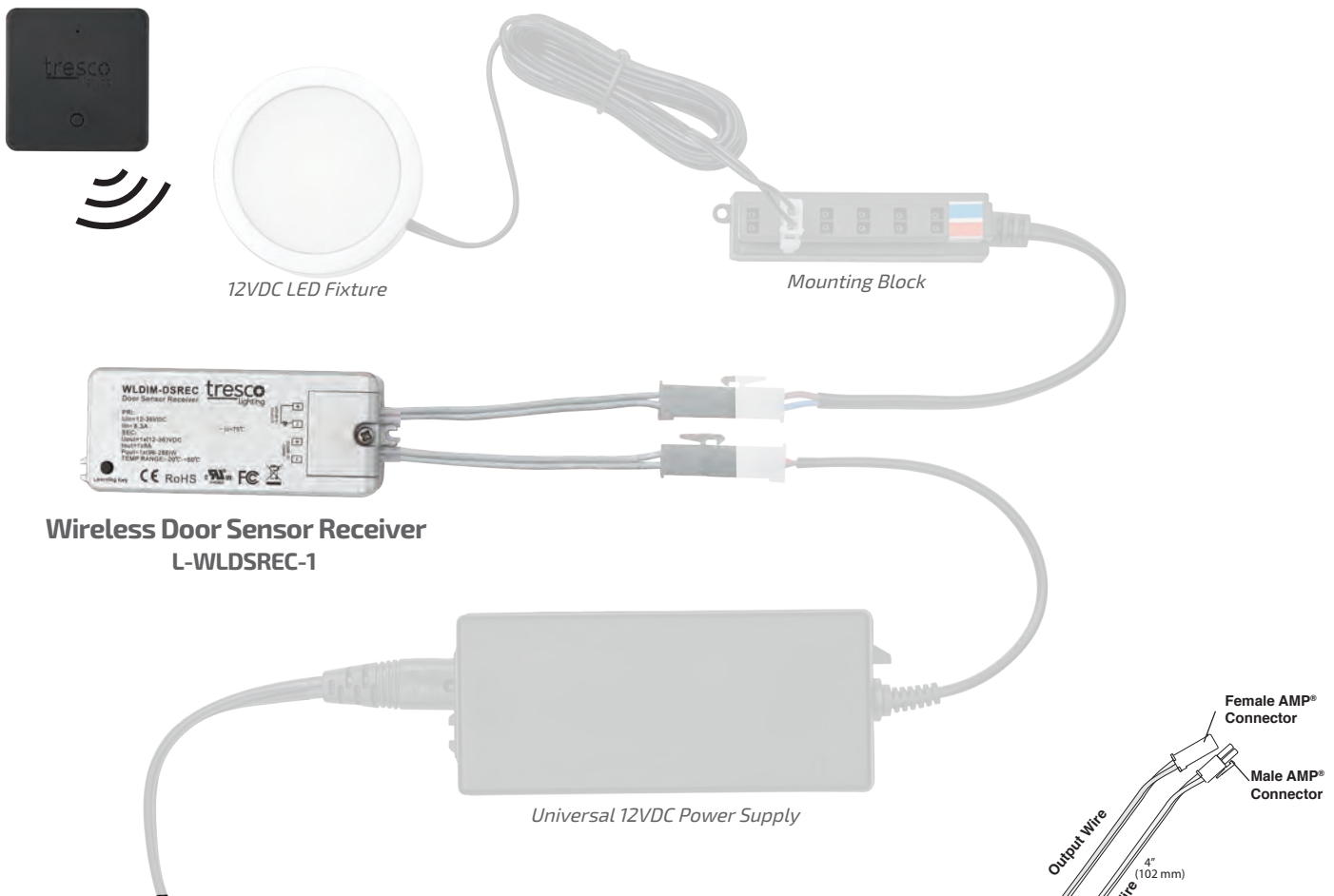
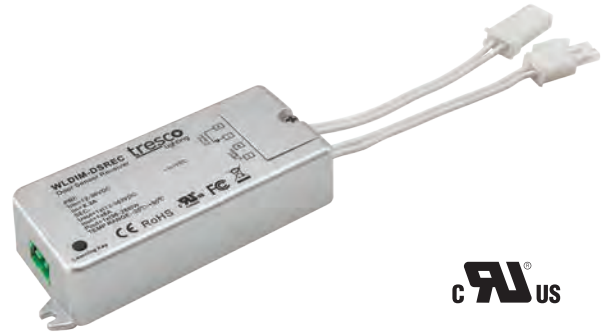

Wireless Door Sensor Receiver
L-WLDSREC-1

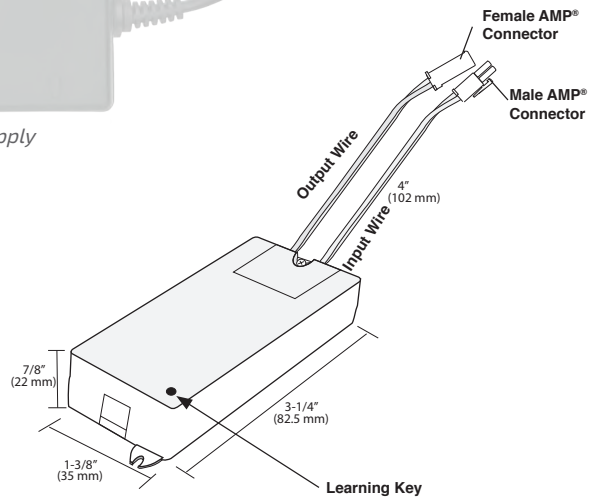

Part #	Description
L-WLDSREC-1	12/24VDC Wireless Door Sensor Receiver

Single receiver can be programmed with up to 4 door sensors.

NEW!

Wireless Door Sensor

Features:

Allows light to be controlled by multiple doors

Black or Nickel

Simple push-button pairing with receiver (sold separately)

Program up to (4) sensors to a single L-WLDSREC-1 receiver

No cumbersome, messy wires to have to hide inside your cabinetry

Mounting hardware (included)



Activated by a magnet; simply adhere to the inside of cabinet door with included double-stick adhesive



Comes with (3) stick-on magnet covers in black, brown and white

Part #	Description
L-WLDS-BL-1	FREEDiM Black Wireless Door Sensor
L-WLDS-NI-1	FREEDiM Nickel Wireless Door Sensor

Must have at least one receiver (L-WLDSREC-1) to operate

FREEDiM

WIRELESS CONTROL



Long-lasting CR2025 battery

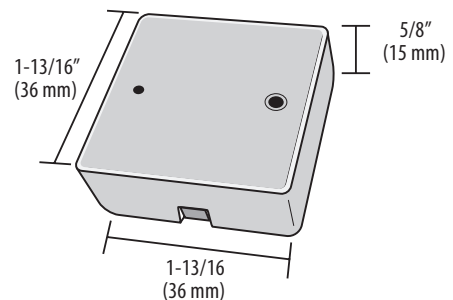
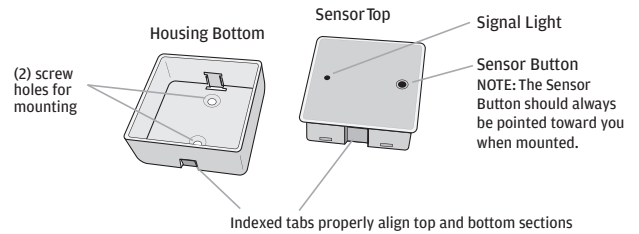

NEW!
**RGB-CCT
 Controller/Receivers**

12VDC
 24VDC



Features:

- 60W capacity (12VDC); 96W capacity (24VDC)
- Digital user interface
- Power failure memory
- Simple one-button programming of FREEDiM Series wireless controls
- Compatible Tresco® FREEDiM series RGB or CCT hand and wall controllers (sold separately)
- Works with any 12/24VDC Tresco® RGB or CCT low voltage lights
- Complete with pigtails for RGB or CCT connection
- Tuning of the RGB or Color temperature from 2700K-6500K

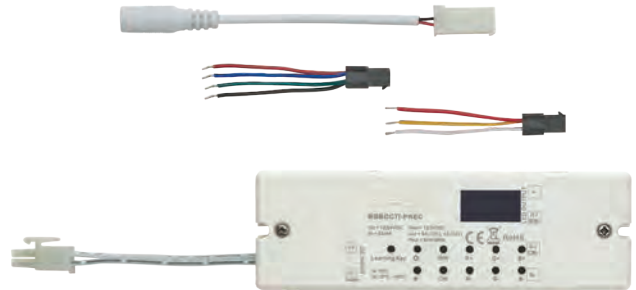

Parent Controller/Receiver
 L-RGBCCT1-PREC-1

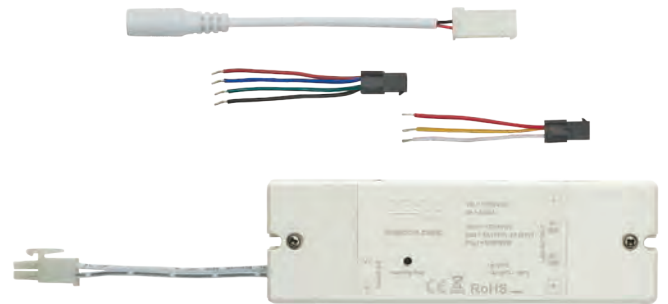

Child Controller/Receiver
 L-RGBCCT1-CREC-1

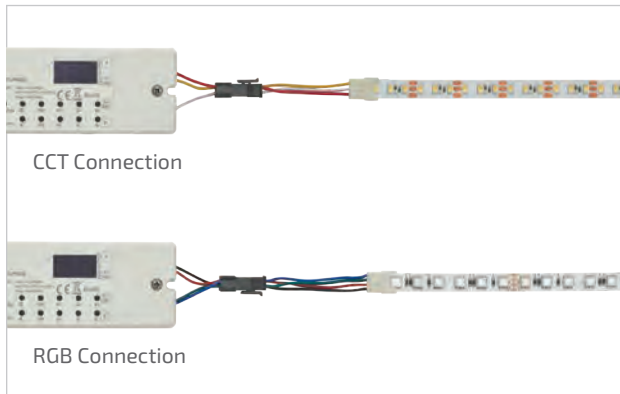

Display in RGB mode. RGB values can be tuned in increments of 1



Display in CCT mode. CCT values can be tuned in increments of 15-16K (Color temperature is range)

Part #	Description
L-RGBCCT1-PREC-1	12VDC/24VDC RGB-CCT Parent Controller/Receiver
L-RGBCCT1-CREC-1	12VDC/24VDC RGB-CCT Child Controller/Receiver

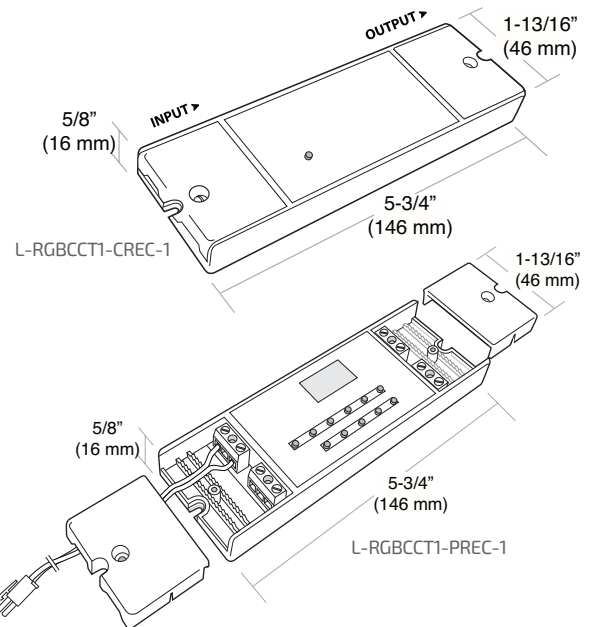

12VDC Setup

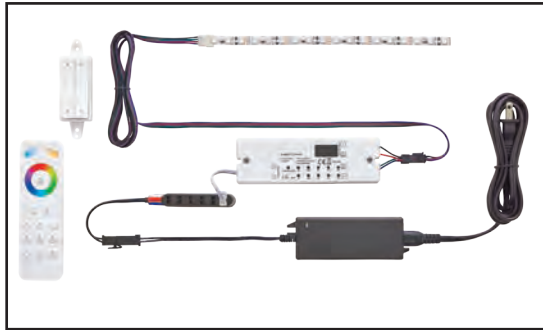

24VDC Setup

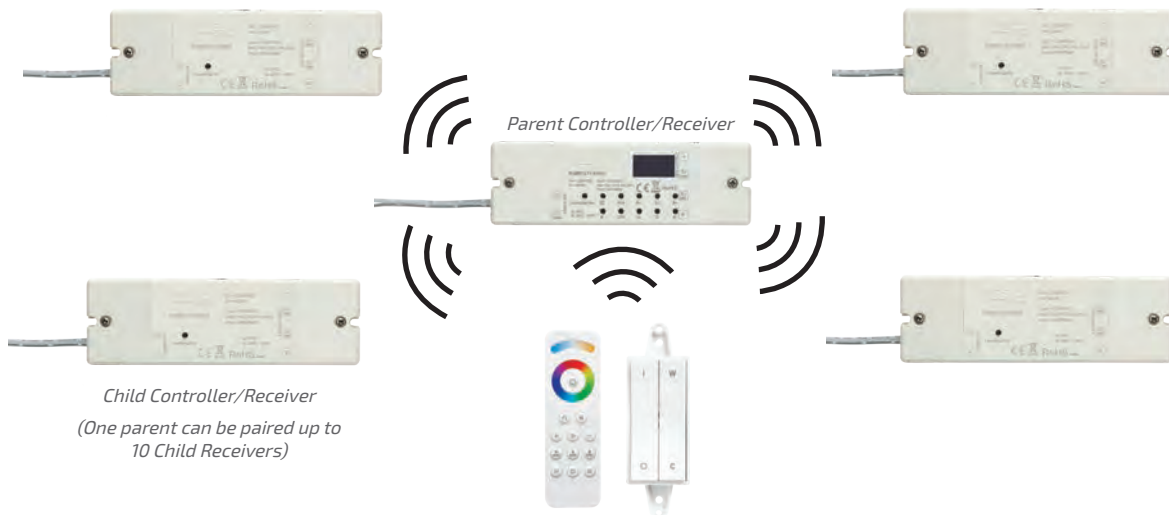
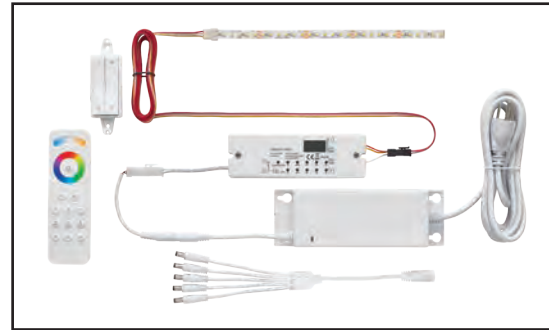

Child Controller/Receiver
(One parent can be paired up to 10 Child Receivers)

Wireless remote controls 1 parent per zone and 10 child receivers per parent

RGB-CCT Wall Controllers



PATENT NO. 9,818,559 B2

- (2) configurations: RGB or CCT (White tunable)
- Can be programmed with up to (1) parent and (10) child receivers
- Fits Decora® style wall plates
- 65 ft. (19 m) range of control from dimmer to receiver
- Controls all Tresco RGB or CCT low voltage lights
- RGB/CCT receivers required (sold separately)
- Long-lasting CR1625/1620 battery (included)

RGB

Easy touch Red, Green, Blue and on/off/dimming controls

CCT - White tunable

Easy touch warm 2700K to daylight 6500K and on/off/dimming controls



Part #	Description
L-WLD-CCT-WH-1	CCT FREEDiM Deco Wall Dimmer White
L-WLD-RGB-WH-1	RGB FREEDiM Deco Wall Dimmer White

NEW!

RGB-CCT Wireless Remote



Features:

Intuitive and ergonomic design

Can control RGB and CCT

Touch control for color mixing

Quick set buttons for common CCT and static RGB values

Program up to (2) separate zones and control independently

(10) preset RGB sequences with speed control (i.e. fade in, fade out)

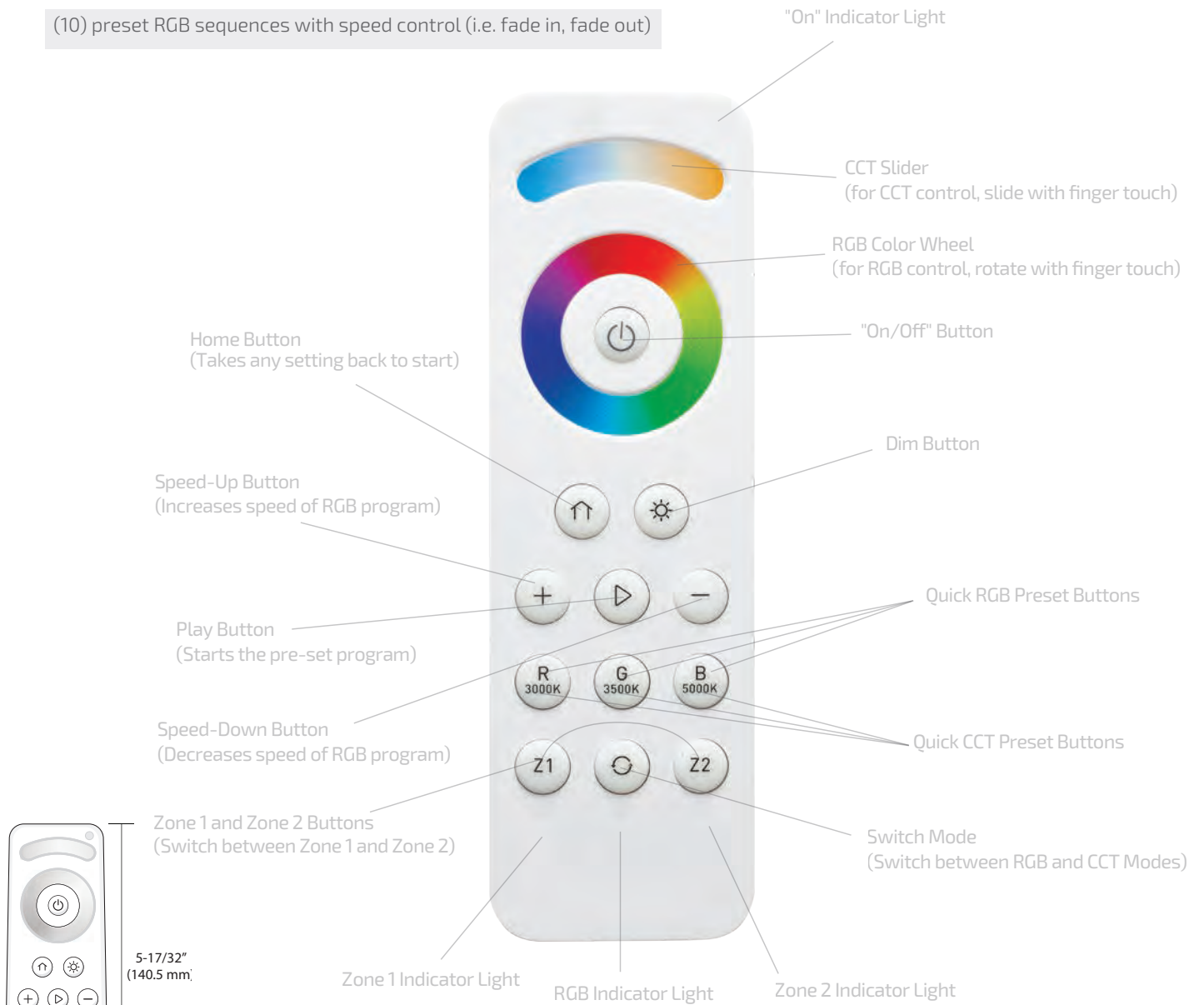

Part #	Description
L-RGBCCT-RMT-1	RGB-CCT Wireless Hand Remote

A single remote can control 1 parent and 10 child receivers per zone

1-23/32"
(44 mm)

Wireless Remote Control Dimmers

12VDC
24VDC

Remote Control LED Dimmers feature radio-frequency, remote-control dimming to adjust lights from anywhere in the room up to 30' (9 m). The remote control provides on/off power and dims lights from 100%-1%.



Universal Remote Dimmer

Controls up to 12VDC/60W or 24VDC/96W of LED lighting

Features a built-in memory that recalls the last setting when turned on

Comes with two remote controls (one as a backup)

No line of sight required

Can control multiple dimmers in same room with single remote control for universal dimming

Dims lights from 100%-1%

Dedicated Remote Control Dimmer

Controls up to 12VDC/60W or 24VDC/96W of LED lighting

Features a built-in memory that recalls the last setting when turned on

No line of sight required

Comes with two remote controls (one extra, as a backup) that are synchronized to control the same dimmer

Can use multiple independently controlled dimmers in the same room

Dims lights from 100%-1%

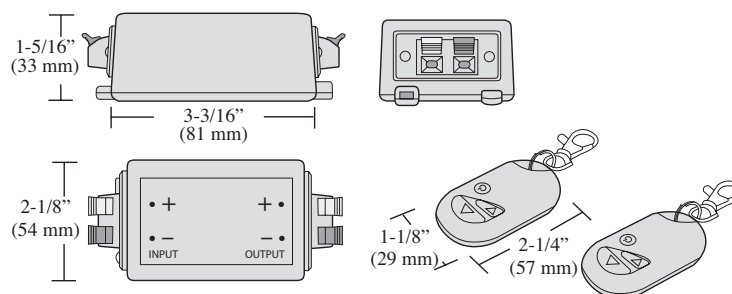

Part #	Description
L-LED-DIMRMT-12V8A-1	LED Dedicated Remote Control Dimmer, 12/24VDC
L-LED-DIMRMT-12V8A-U-1*	LED Universal Remote Control Dimmer, 12/24VDC
L-24VDC3INADP-WH-1	12VDC to 24VDC Controller Adaptor Cord Set White
L-24VDC3INADP-BL-1	12VDC to 24VDC Controller Adaptor Cord Set Black

Adaptor Cord Set required for 24VDC operation.

***Recommended not to exceed 3 per room**

Placement of multiple dimmers in a room may be critical for proper function depending on set-up and obstacles.

Oval Controllers

12VDC

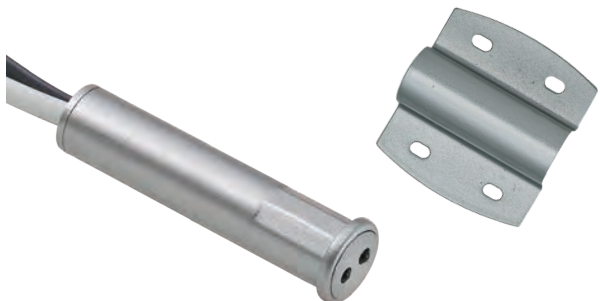

Door Sensor Controller

Door open, light on; door closed, light off

- Max wattage: 60W
- Sensor range: 1/4" - 2" (6 mm - 50 mm)
- Cable input: 79" (2 m)
- Cable output: 6" (152 mm)
- Finish: Black/Nickel

Motion Controller

Turns on when human motion is detected

- Max wattage: 60W
- Sensor range: 0-5' (1500 mm)
- Viewing degree: 100°
- Time on: 30 secs if no motion
- Cable input: 79" (2 m)
- Cable output: 6" (152 mm)
- Finish: Black/Nickel

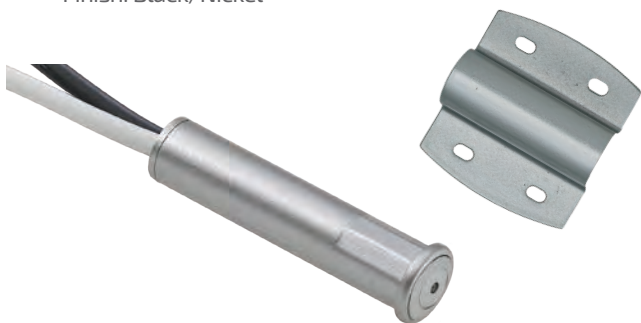

Dimmer Controller

Touch on/off and 0-100% dimming control

- Max wattage: 60W
- Cable input: 79" (2 m)
- Cable output: 6" (152 mm)
- Finish: Black/Nickel
- * Hold finger down for dimming

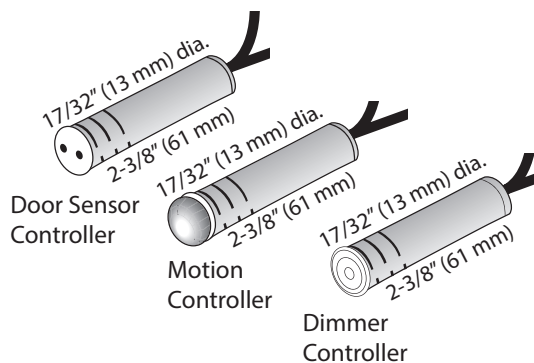

Part #	Description
L-LED-OVLTD-**-1	60W 12VDC Oval Recess/Surface Mnt. Touch Dimmer
L-LED-OVLDS-**-1	60W 12VDC Oval Recess/Surface Mnt. Door Sensor
L-LED-OVLMS-**-1	60W 12VDC Oval Recess/Surface Mnt. Motion Sensor
L-DB1732-1	17/32" (13.5 mm) Drill Bit for Recess Mount

**Available in Black (BL) and Nickel (NI)
Surface mount plate packaged with each controller.

NEW!

Profile Controllers

12VDC

24VDC



(5) profiles to choose from – angled, curved, recessed, round or square

Capacity: 12VDC/60W; 24VDC/96W

(2) configurations: Touch Dimmer and Touch Dimmer/Motion Combo

Power failure memory (retains last setting)

79" (2 m) input and 3" (76 mm) output

Controls all Tresco® dimmable low voltage lights

Various finishes available

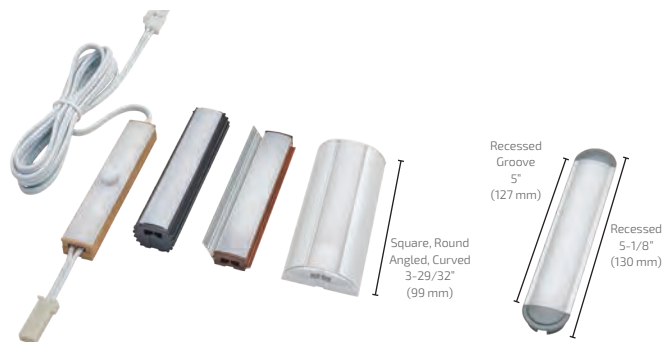

Touch Dimmer Controller

Touch ON/OFF

Gradual dimming from 100%-5%

Power failure memory (retains last setting)

10-hour automatic energy-saving shutoff

Touch Dimmer and Motion Controller Combo

Premium Panasonic motion sensor

Touch dimmer function 100/75/50/25/Off

(3) time settings: 30 seconds, 3 minutes, 30 minutes or customization available

Motion sensor can be bypassed

Dimming function works in motion sensor mode or stand-alone mode

10-hour automatic energy-saving shut off in dimmer only mode

*Motion sensor time can be customized by Tresco®

Part #	Description
L-XSQRDIMA-XX-1	Dimmer Module for Square Profile
L-XCRVDIMA-XX-1	Dimmer Module for Curved Profile
L-XANGDIMA-XX-1	Dimmer Module for Angled Profile
L-XRNDDIMA-XX-1	Dimmer Module for Round Profile
L-XRECDIMA-XX-1	Dimmer Module for Recessed Profile
L-XSQRCBOYY-XX-1	Dimmer/Motion Sensor Combo for Square Profile
L-XCRVCBOYY-XX-1	Dimmer/Motion Sensor Combo for Curved Profile
L-XANGCBOYY-XX-1	Dimmer/Motion Sensor Combo for Angled Profile
L-XRNDCCBOYY-XX-1	Dimmer/Motion Sensor Combo for Round Profile
L-XRECCBOYY-XX-1	Dimmer/Motion Sensor Combo for Recessed Profile

All controllers are 3-15/16" (100 mm) in length except recessed profiles which are 5-1/8" (130 mm)

XX= Insert SC for Satin Clear, BL for Black, WH for White, DC for Dark Cherry, NSM for Natural Soft Maple Round and recessed profiles only available in Satin Clear and Black

30 second, 3 minute, and 30 minute versions of Dimmer/Motion Sensor Combo available.

YY = 30S (30 second), 3M (3 minute) or 30M (30 minute)

Mounting:

(Mounting accessories are dependent upon the profile)

Square/Curved: Magnet mount (magnet already built-in) with metal plate and u-clips

Round: U-Clips

Angled: Screw-in

Recessed: Route a channel in wood 21/64" (8.33 mm) minimum depth x .75" (19 mm) width x 5" (127 mm) length and pressure fit this extrusion in place.

Manual In-Line Rotary Dimmer

12VDC
24VDC

Features:

Capacity: 12VDC/48W; 24VDC/96W

100-0% dimming and on/off power

79" (2 m) input lead and 8" (203 mm) output lead

(2) screws for mounting

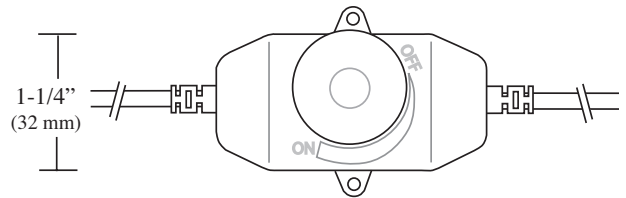
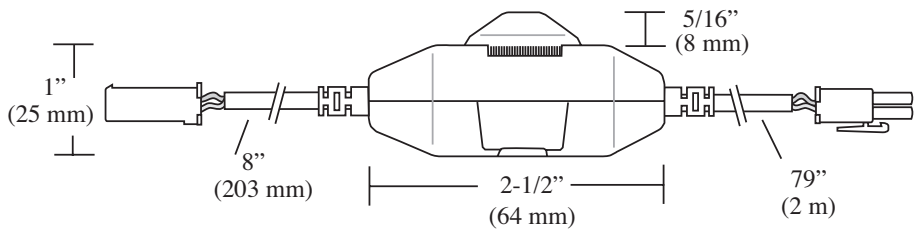

Part #	Description
L-LED-DIMCON-BL-1	LED Black Inline Rotary Dimmer, 12VDC/24VDC
L-LED-DIMCON-WH-1	LED White Inline Rotary Dimmer, 12VDC/24VDC
L-24VDC3INADP-BL-1	12VDC to 24VDC Controller Adaptor Cord Set Black
L-24VDC3INADP-WH-1	12VDC to 24VDC Controller Adaptor Cord Set White

Adaptor Cord Set required for 24VDC operation.

Round Switch

12VDC
24VDC

Capacity: 12VDC/60W; 24VDC/96W



Front View



Available in Black and White

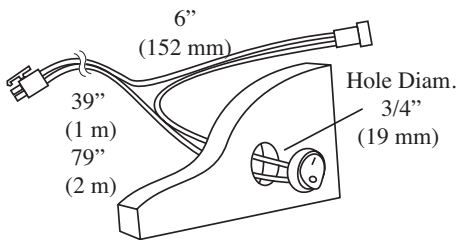
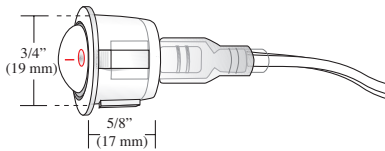
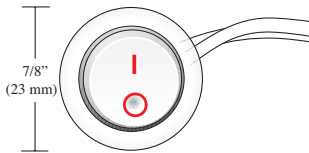

Part #	Description
L-RDSW-1M-BL-1	Black Rocker Switch w/ 39" (1 m) Lead, 12/24VDC
L-RDSW-1M-WH-1	White Rocker Switch w/ 39" (1 m) Lead, 12/24VDC
L-RDSW-2M-BL-1	Black Rocker Switch w/ 79" (2 m) Lead, 12/24VDC
L-RDSW-2M-WH-1	White Rocker Switch w/ 79" (2 m) Lead, 12/24VDC
L-24VDC3INADP-BL-1	12VDC to 24VDC Controller Adaptor Cord Set Black
L-24VDC3INADP-WH-1	12VDC to 24VDC Controller Adaptor Cord Set White

3/4" (19 mm) hole required.
Adaptor Cord Set required for 24VDC operation.

Touch On/Off Switch

120V

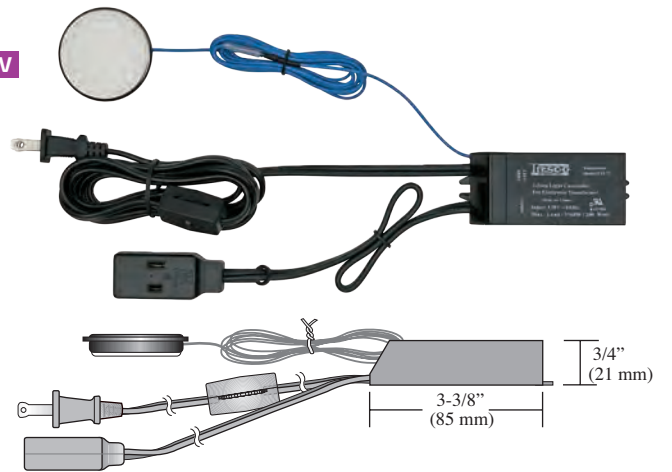
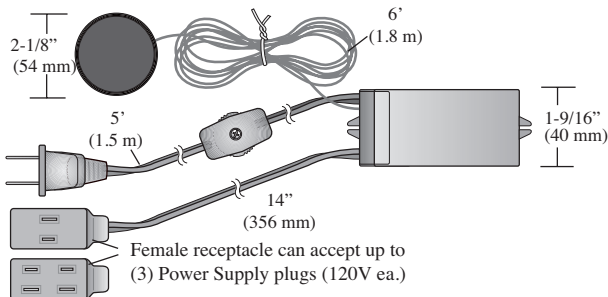

Part #	Description
L-TS2-72-1	Touch On/Off w/Cord And Touch Pad. Black, 200W

Controls 12VDC / 24VDC
Plug-in Power Supplies

On/off switch touch pad attaches to surface with adhesive backing. Power supply plugs into on/off switch.

Install Accessories

Wire Channel



Features:

Plastic channel for wire management

Available in (3) finishes: Black, Brown and White

Sold in 5' (1.5 m) lengths

Easily cut to size in the field

Durable adhesive mounting

Part #	Description
L-WM5-BL-1	5' (1.5 m) Wire Management Channel Black
L-WM5-BR-1	5' (1.5 m) Wire Management Channel Brown
L-WM5-WH-1	5' (1.5 m) Wire Management Channel White

12VDC/24VDC Class 2 Wire and DIY Connectors

Part #	Description
L-16CL2-WH50-1	50' (15 m) Roll 16 AWG 12/24VDC Class 2 Wire White
L-LED-WCON-WH-1	12/24VDC DIY Barrel Connectors White (1 bag of 10)
L-LED-WCON-BL-1	12/24VDC DIY Barrel Connectors Black (1 bag of 10)

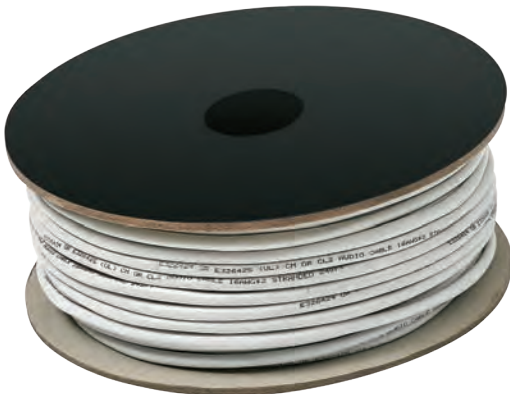

See Sales Support section (page# 178) for instructions on how to use Class 2 wire with Barrel Connectors.

Wire rated for low-voltage in-wall use



AMP® Connector and Extractor



Part #

- L-PINEXT-1
- L-MALE-AMP-10-1

Description

- AMP® Connector Extraction Tool
- AMP® Connector for Light Fixture (box of 10)

Pin Extractor safely removes AMP® Connectors.

VHB Tape



Part #

- L-VHBTPE-1134-1

Description

- 7/16" (11 mm) x 111-1/2' (34 m) VHB Adhesive Tape Roll

Automotive grade VHB tape can be used to mount all fixtures or as a base layer for mounting Tape LED products.

Starter/Extension Cord

Features:

Low-voltage wire

Used to extend the starter leads for any Tresco® lights

7 lengths (12VDC) 3 lengths (24VDC)

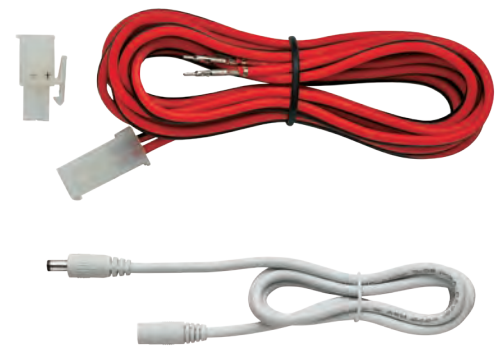

12VDC

Part #

- L-LED-LINKD-8-1
- L-LED-LINKD-15-1
- L-LED-LINKD-25-1
- L-LED-LINKD-60-1
- L-LED-LINKD-120-1
- L-LED-LINKD-180-1
- L-LED-LINKD-245-1

Description

- 8 cm (3") 12VDC Starter/Link/Extension Cord
- 15 cm (6") 12VDC Starter/Link/Extension Cord
- 25 cm (10") 12VDC Starter/Link/Extension Cord
- 60 cm (24") 12VDC Starter/Link/Extension Cord
- 120 cm (48") 12VDC Starter/Link/Extension Cord
- 180 cm (72") 12VDC Starter/Link/Extension Cord
- 245 cm (96") 12VDC Starter/Link/Extension Cord

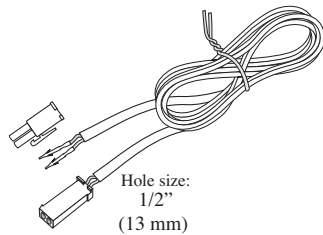

24VDC

Part #

- L-24BBEXT-1M-1
- L-24BBEXT-2M-1
- L-24BBEXT-3M-1

Description

- 1 m (39") 24VDC ML/FML Barrel Extension, White
- 2 m (79") 24VDC ML/FML Barrel Extension, White
- 3 m (119") 24VDC ML/FML Barrel Extension, White

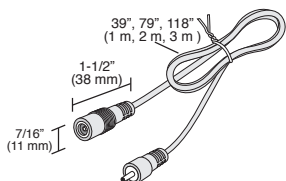

Drill Bit

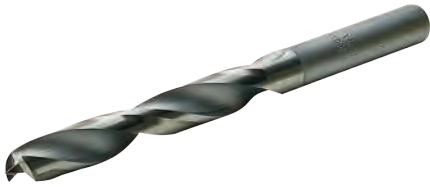

Part #	Description
L-DB1732-1	17/32" (13 mm) Drill Bit

For installing Oval Controllers

Phillips Screwdriver



Part #	Description
L-P1SCRWDR-1	#1 Phillips Screwdriver

Mini Flathead Screwdriver



Part #	Description
L-MFSCRWDR-1	Mini Flathead Screwdriver

Tools of the Trade Starter Kit



Starter Kit Includes:

2 mount blocks	Mini flathead screwdriver	(1) 17/32" drill bit
50' (15 m) roll of class 2 wire	AMP® extractor	VHB tape
10 AMP® connectors	10 barrel connectors	15" (381 mm) canvas bag
Phillips screwdriver	10 wire management clips	



Starter Kit:

Part #	Description
L-TOOLKIT-1	Tools of the Trade Tool Bag Starter Kit

Replacement Items:

Part #	Description
L-16CL2-WH50-1	50' (15 m) Roll 16 AWG 12/24VDC Class 2 Wire White
L-TRANS-MNT-BL-1	Extra 6-Snap Mounting Block
L-MALE-AMP-10-1	AMP® Connector for Light Fixture (1 bag of 10)
L-WCLP-WH-1	Wire Management Adhesive Clips White (1 bag of 10)
L-LED-WCON-WH-1	12/24VDC DIY Barrel Connectors White (1 bag of 10)
L-LED-WCON-BL-1	12/24VDC DIY Barrel Connectors Black (1 bag of 10)
L-DB1732-1	17/32" (13 mm) Drill Bit
L-P1SCRWDR-1	#1 Phillips Screwdriver
L-MFSCRWDR-1	Mini Flathead Screwdriver
L-PINEXT-1	AMP® Connector Extraction Tool
L-VHBTPE-1134-1	7/16" (11 mm) x 111-1/2' (34 m) VHB Adhesive Tape Roll





BATTERY

Battery

Alpha

Battery



Available Finishes:



Nickel (NI)

.8W	26 Lumens	53°
------------	------------------	------------

Enlightenment begins with Alpha. The hassle-free wireless installation, high capacity USB rechargeable battery and slim profile of this all-purpose ecological light allows illumination of areas that are frequently left in the dark. The Alpha light is perfect for utility closets, drawers, and cabinets.

Dimensions:

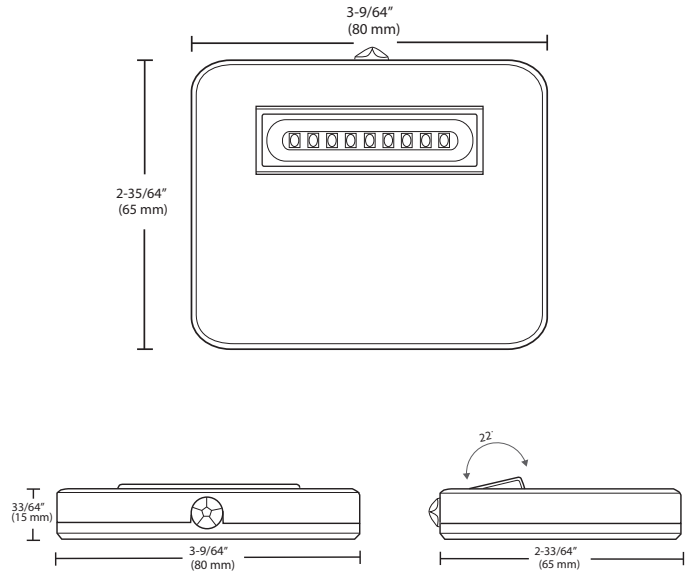

Specifications:



Wattage	Lumens	Battery	Diode Life	Mounting	Motion Detection Range	Motion Detection Angle	"On" Time	Warranty	Beam Angle
.8W	26	5VDC Mini USB Rechargeable	20,000 Hours	Surface	79" (2 m)	50°	10 Seconds	3 Year	53°

Photometric Data			Color Temperature	
	Height	Light Output	Beam Area	
	1ft (.3 m)	12.50Fc (134.5lx)	1.7ft L x 3ft W (.5 m L x .9 m W)	
	3ft (.9 m)	1.39Fc (14.9lx)	3ft L x 3ft W (.9 m L x .9 m W)	
6ft (1.8 m)	0.35Fc (3.7lx)	10.3ft L x 18.2ft W (3.1 m L x 5.5 m W)		
			<p>Warm White Warm to Neutral Cool White Daylight</p> <p>2700K 3000K 4500K 5500K 6500K</p> <p>▲ Warm (3000K) ▲ Cool (5000K)</p>	

L-HALPHA-WNI TESTED

See page 172 for part numbers and descriptions

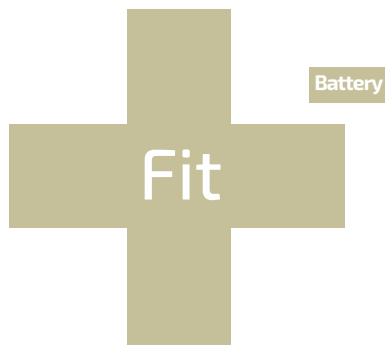

.8W

32 Lumens



Fit is the light that epitomizes form and function with its slim profile. Recessed in a depth of just 29/64" (10 mm), it blends into the cabinet creating a clean appearance uncommon in other wireless fixtures, making it the picture perfect light that begs to be seen.



Available Finishes:



Nickel (NI)

Dimensions:

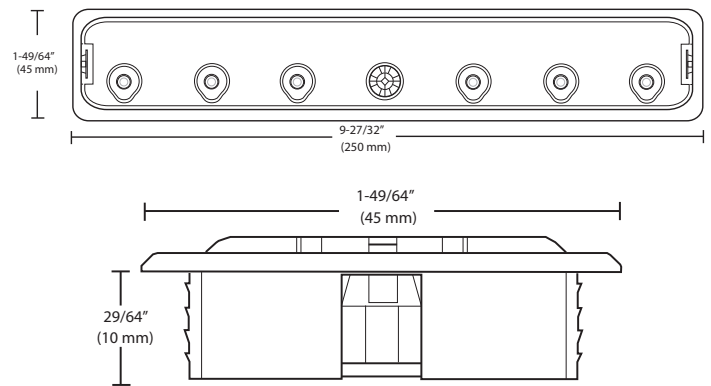

Specifications:



Wattage	Lumens	Battery	Diode Life	Mounting	Motion Detection Range	Motion Detection Angle	"On" Time	Warranty	Beam Angle
.8W	32	AAA x 5	20,000 Hours	Recess	79" (2 m)	110°	10 Seconds	3 Year	

Photometric Data				Color Temperature	
	Height	Light Output	Beam Area		
	1ft (.3 m)	52.70Fc (1777.7lx)	.7ft L x .7ft W (.09 m L x .09 m W)		
	3ft (.9 m)	5.86Fc (196.8lx)	2.2ft L x 2.2ft W (.3 m L x .3 m W)		
6ft (1.8 m)	1.46Fc (49.1lx)	4.4ft L x 4.3ft W (.6 m L x .6 m W)			

L-HFIT-CNI Tested

See page 172 for part numbers and descriptions

● Required
● Optional

Battery Alpha Series

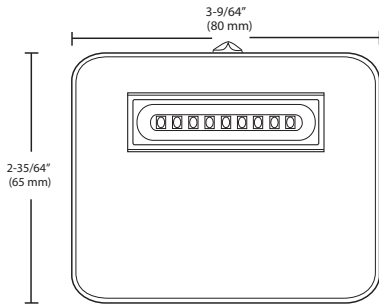

Part

Description

L-HALPHA-WNI-1	Battery Powered Light w/ Motion Sensor 3000K, Nickel
L-HALPHA-CNI-1	Battery Powered Light w/ Motion Sensor 5000K, Nickel

Includes mounting bracket and USB cord for re-charging

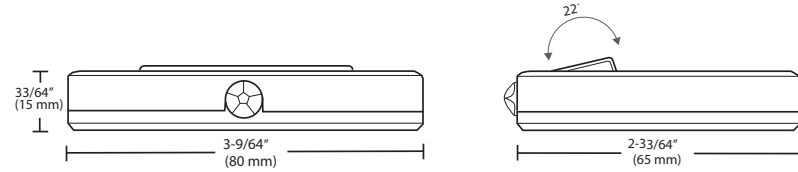

Battery Fit

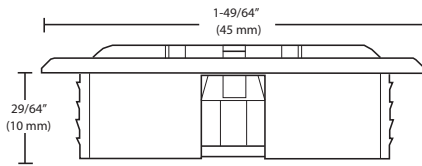

Part

Description

L-HFIT-CNI-1	Battery Powered Fit light w/ motion sensor, 5000K, Nickel
--------------	---

5 x AAA Batteries included

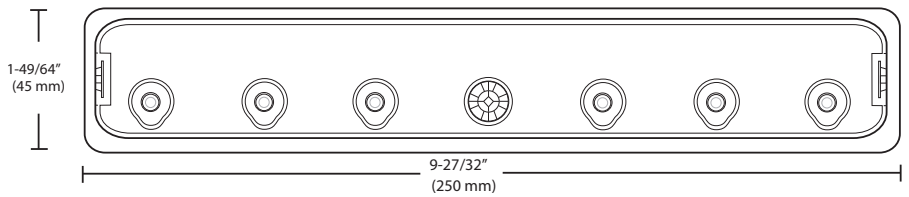



Basic Specifications to Install Tresco 12VDC Lights With a PLUG-IN Power Supply

To control each light individually, use [Option 1](#).

To control all lights at the same time, use [Option 2](#).

Note: Before making final connections, make sure to add up all the wattage of the lights used. Do not exceed the wattage rating of the Power Supply and each Controller.

Note: 12VDC plug-in Power Supplies are dimmable on the 12VDC side only.

- LEGEND:**
- A. Power Supply**
Select a Plug-In Power Supply.
For example: an 18W Power Supply can power up to (18) 1W Lights or (6) 3W Lights.
 - B. Mounting Block**
(1) Mounting Block is included with each plug-in Power Supply.
Up to (6) Controllers and/or Lights can plug into (1) Mounting Block.
 - C. Controllers**
Select from several different types of Tresco Controllers.
 1. Remote Control Dimmer
 2. Manual Rotary Dimmer
 3. Motion Sensor Controls
 4. Touch Dimmer Controls
 5. Door Sensors
 - D. Tresco Lights**
12VDC LED Lights

Option 1: Up to six Controllers plugged into (1) Mounting Block

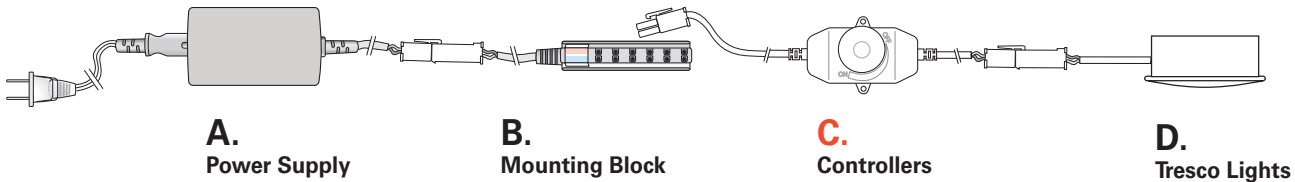

Option 2: One Controller plugged in before the Mounting Block

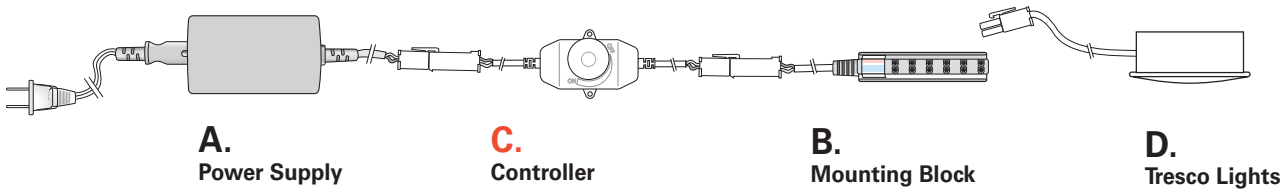

Typical Installation Showing One Controller for All Lights (Linear vs. Puck)

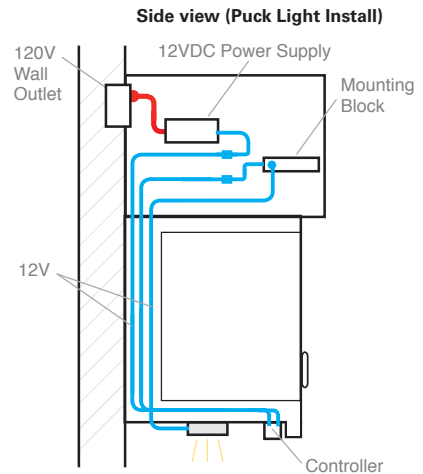
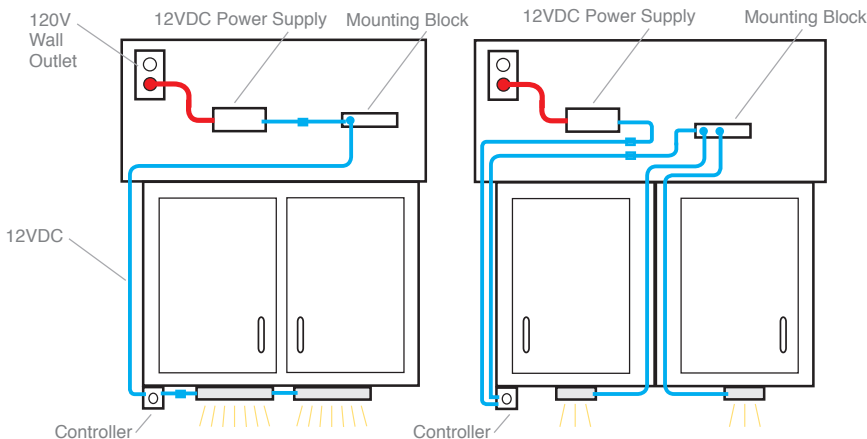

Basic Specifications to Install Tresco 12VDC Lights With a HARDWIRE Power Supply

To turn all lights on/off at the same time, use a [Wall Switch](#).

To control (dim) all lights at the same time, use a [Wall Dimmer](#).

Note: Before making final connections, make sure to add up all the wattage of the lights used. Do not exceed the wattage rating of the Power Supply.

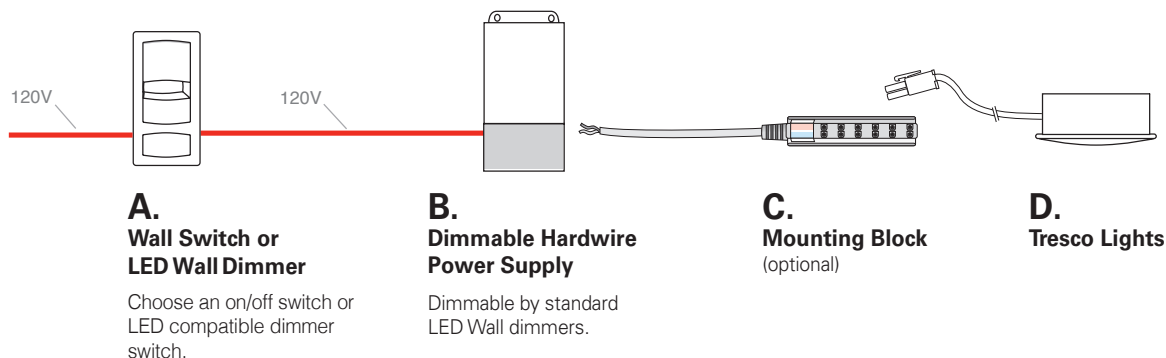

Caution: DO NOT dim a receptacle. This is a potential hazard and can cause lights to flicker as well as damage Power Supply.

Typical Hardwire Installation for 12V Pocket® Lights

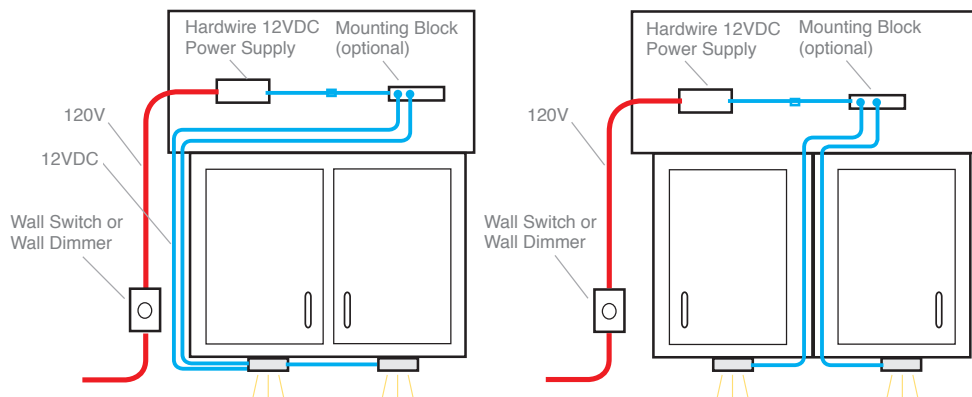

LEGEND:
Red = 120V Wiring
Blue = 12VDC Wiring

Typical Hardwire Installation for 12V Linear Lights

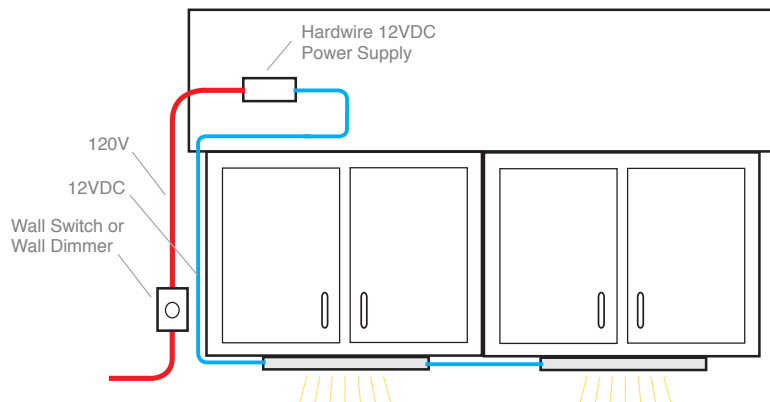

Side view (Linear Install)

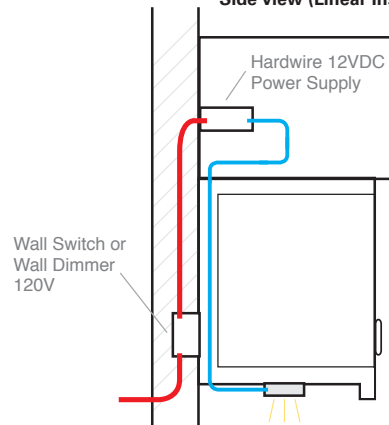

How to Wire a Kitchen with Tresco 12VDC Lights for Frameless or Framed Cabinets

Wires that are attached to or accompany Tresco® lighting systems are not approved for in-wall use. Class 2 wire must be used (purchased separately). Class 2, 16-gauge wire is the minimum for in-wall applications.

For in-wall wiring – typically used for frameless cabinets – use 16-gauge Class 2 wire (minimum) to route wire through kitchen walls (see 1st illustration below).

For outside of wall wiring – typically used for framed cabinets – use wires provided with Tresco lighting fixtures with appropriate link and extension leads (LINKD series) that are available in several lengths.

- To wire a kitchen with Tresco 12V lights, first roughly lay out lighting system to help verify final positioning of all components. Make sure to add up all the wattage of the lighting system. Do not exceed the wattage rating of the Power Supply. If using a Tresco D.I.Y. Controller, do not exceed the wattage of the Controller.

IN-WALL Wiring:

Typical for FRAMELESS Cabinets

(example installation of 12VDC Linear Lights)

Note: A licensed electrician should be consulted for wiring through walls and other permanent structures. When mounting and wiring a light system, follow all local electric codes and the National Electrical Code (NEC).

LEGEND:
Red = 120V
Purple = Class 2 Wire
Blue = 12VDC

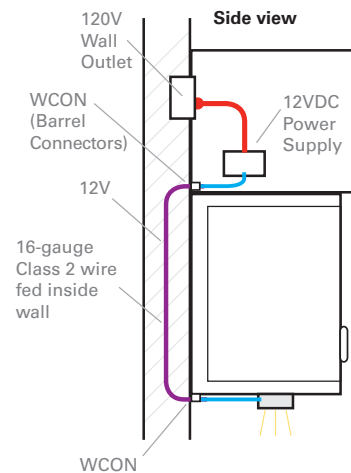
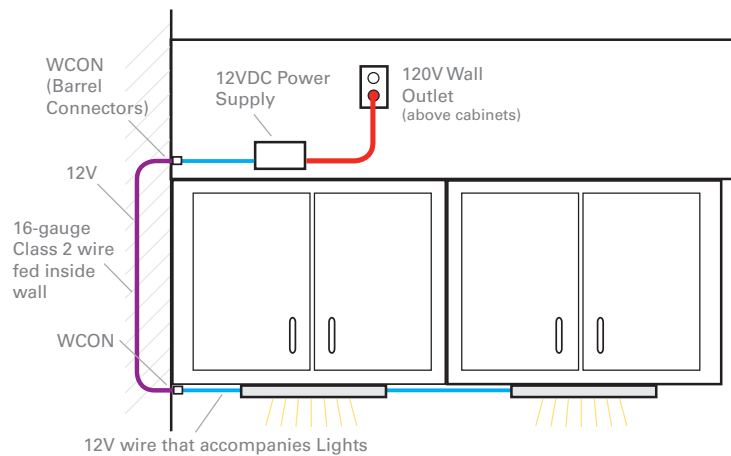

OUTSIDE of Wall Wiring:

Typical for FRAMED Cabinets

(example installation of 12VDC Pocket® Lights)

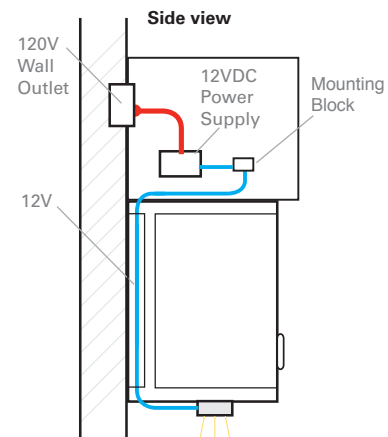
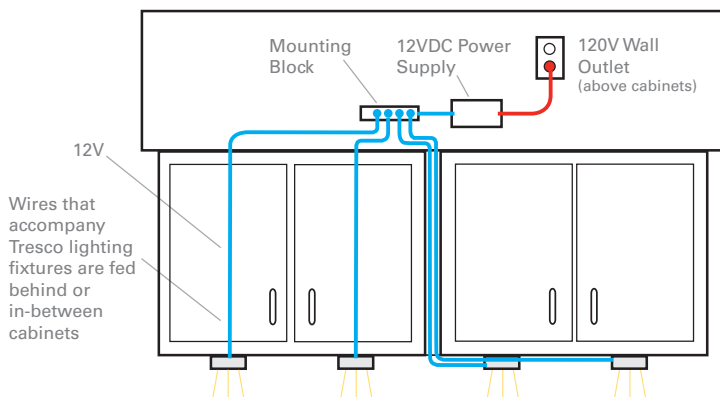

Length of Wire from Power Supply to Run of Lights

This is a general guide based on a 60 Watt/5 Amp load:

- Recommended maximum length using Class 2, 16-gauge (AWG) wire = 7.6 meters (25 ft.)
- Recommended maximum length using links/extensions that accompany Tresco lights = 4.6 meters (15 ft.)

Use D.I.Y. Connectors with Class 2 Wire For Making Junction Between In-Wall Wiring and Light Fixture Wire

Note: A licensed electrician should be consulted for wiring through walls and other permanent structures. When mounting and wiring a light system, follow all local electric codes and the National Electrical Code (NEC).

- Wires that are attached to or accompany Tresco lighting systems are not approved for in-wall use. Class 2, 16-gauge wires must be used (purchased separately). Class 2, 16-gauge wire is the minimum for in-wall applications.

Items required for in-wall installation:

- (10) Barrel Connectors White L-LED-WCON-WH-1
Black L-LED-WCON-BL-1
- Class 2, 16 AWG wire White, 15.2 m (50 ft.) roll . . . L-16CL2-WH50-1
- Small screwdriver Black, mini slotted L-MFSCRWDR-1

Note: Make sure electrical polarity (positive and negative) is correctly maintained when making junction between Class 2 wire and Light Fixture wire.

- (+) Red to (+) Red
- (-) Black to (-) Black

Note: Fixture wires are tagged (+) (-) when red- and black-colored wires are not utilized.

WCON - Barrel Connectors

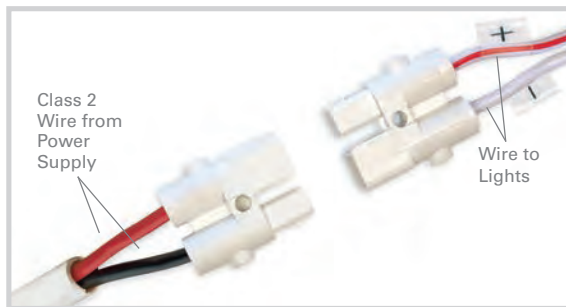

Class 2 Wire



Typical IN-WALL Wiring with Kitchen Cabinets

(example installation of 12V Linear Lights)

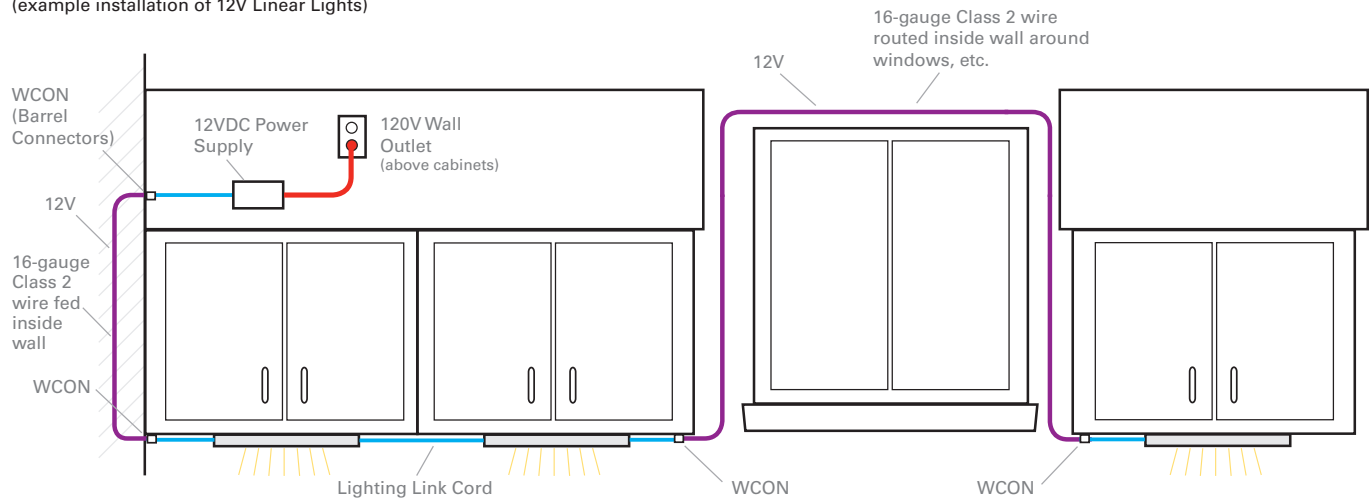

Understanding Voltage Drop

When Installing Tresco 12VDC Lighting Pockit® (Puck) Light Series

- **Note:** The information provided for measuring voltage drop is a general guide only based on the length of the run and assuming 50% load (30W). Voltage drop goes down with less load and voltage drop goes up with more load. Other factors may influence voltage drop. All measurements and calculations are approximate.
- **In-wall wiring:** Wires that are attached to or accompany Tresco lighting systems are not approved for in-wall use. Class 2, 16-gauge (AWG) wires must be used (purchased separately).
- All Tresco Power Supplies can be applied to the information provided herein on voltage drop.

Ideally, Voltage Drop variance should be within 5%. Absolute maximum should never exceed 8%.

- Recommended maximum length using links/extensions that accompany Tresco lights = 4.6 meters (15 ft.).
- Recommended maximum length using Class 2, 16-gauge wire = 7.6 meters (25 ft.).

Voltage drop is the amount of electric current lost due to the resistance of the conductors (wires).

On most installations – even larger installations – voltage drop is not an issue, but excessive voltage drop could result in diminished light output. Keeping wire length in mind is a best practice to ensure optimum light performance.

For instance, if specifications recommend that the maximum length from Power Supply to the first Light not exceed 5 meters (16 ft.), **the light will still work if you exceed that length!** Again the loss is gradual, but an excessive length could result in dimmer light.

Other factors also influence voltage drop, including the number of connectors, quality of the conductor (aluminum vs. copper wires), and cross-sectional area (gauge).

All Tresco wires and cords provided are specifically for wiring **outside of walls** and have a 4.6 meters (15 ft.) maximum length recommendation.

For **in-wall wiring**, stranded Class 2, 16-gauge wires must be used (purchased separately). Also if needed, lower gauge (which means larger wire) helps reduce voltage drop by lowering overall resistance.

12V Pockit® Lights (Puck)

Example 1:

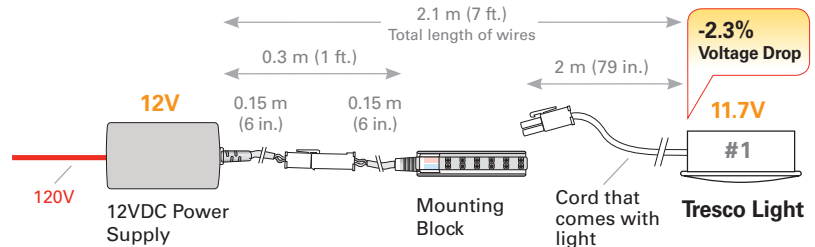

Example 2:

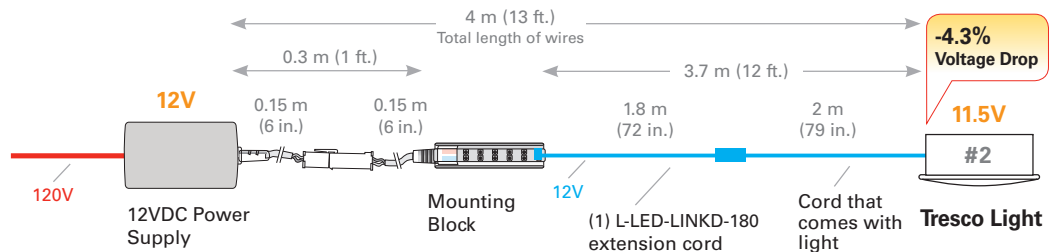

Example 3:

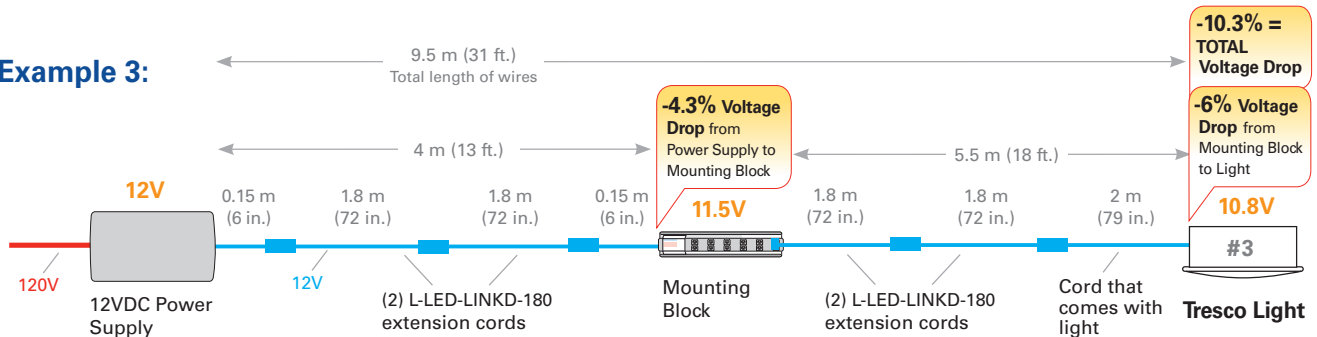

Note: The overall Voltage Drop variance between Light #1 and Light #3 is **8%**, which is noticeable.

Understanding Voltage Drop

When Installing Tresco 12VDC Lighting Linear Linkable Series

Tresco's longest linking cords are 2 meters (79 in.) which is only a 2% voltage drop – without a noticeable difference in light output.

- **Note:** The information provided for measuring voltage drop is a general guide only based on the length of the run and assuming 50% load (30W). Voltage drop goes down with less load and voltage drop goes up with more load. Other factors may influence voltage drop. All measurements and calculations are approximate.

12V Linear Lights Linked in Series Using Link Cords

Linear Lights are typically within 1 meter (3 ft.) of each other without a noticeable voltage drop (less than 1%).

Example 1:

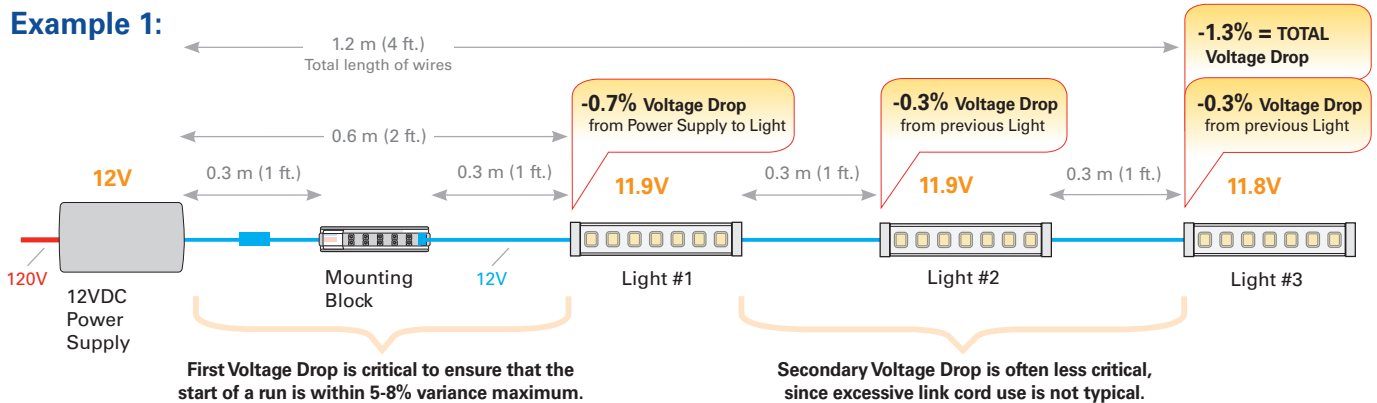

The total Voltage Drop is 1.3% with a variance between Light #1 and Light #3 of 0.6% which is not noticeable.

Example 2:

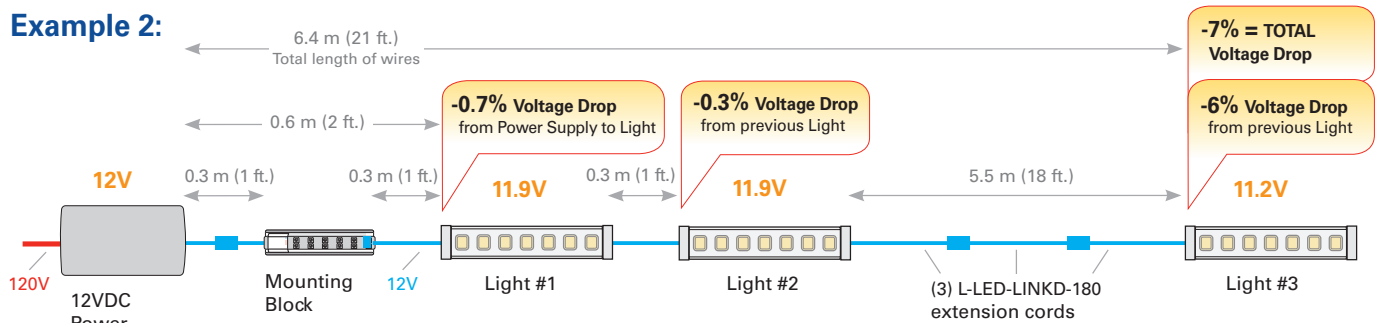

The total Voltage Drop is 7% with a variance between Light #1 and Light #3 of 6.3% which is not noticeable.

Example 3:

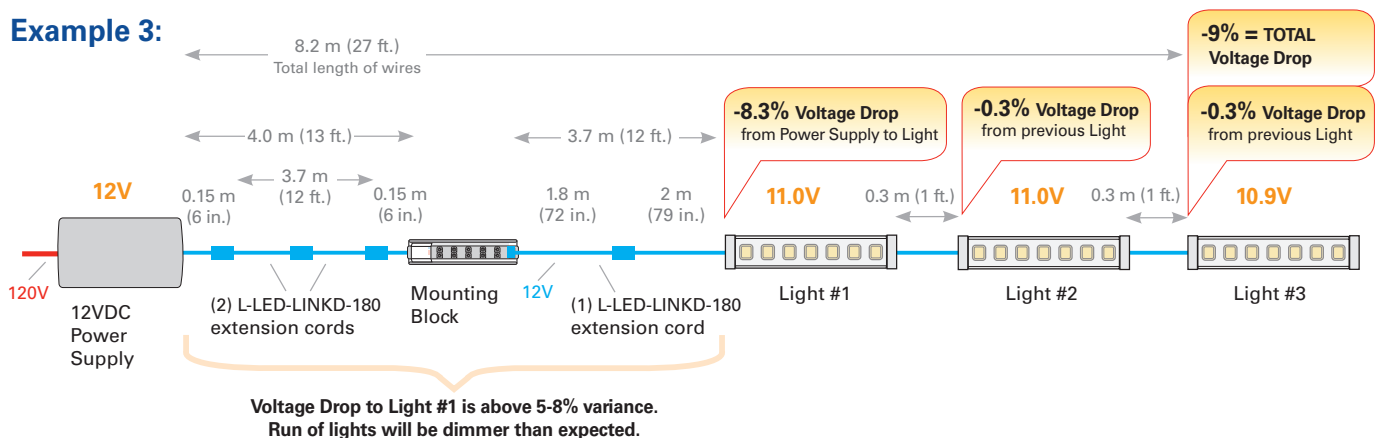

The total Voltage Drop is 9% with a variance between Light #1 and Light #3 of 0.7% which is not noticeable.

L-12DCH60X1-1.....	45, 67, 88, 139, 140	L-CTCL-153P-WH-1.....	47, 149	L-FLXCOB24-35RU-1.....	90
L-12DCH60X1-1*.....	146	L-DB1732-1.....	160, 166, 167	L-FLXCOB24-48RU-1.....	90
L-12DCH60X3-1.....	45, 67, 88, 139, 140	L-DC-ELT15WP-CON-1.....	45, 67, 88, 139, 140, 144	L-FLXCOB24-65RU-1.....	90
L-12DCH60X3-1*.....	146	L-DC-ELT18-CON-1.....	45, 67, 88, 139, 140, 142	L-FLXTPE-12CCT-1.....	102
L-16CL2-WH50-1.....	164, 167	L-DC-ELT6WP-CON-1.....	45, 67, 88, 139, 140, 144	L-FLXTPE-12RGB-1.....	103
L-1BRL5-1.....	90, 132, 147, 148	L-DC-EQ30-1.....	45, 67, 88, 139, 140, 144	L-FLXTPE-24CCT-1.....	102
L-24B2SPKT-2M-1.....	90, 117	L-DC-EQ60-1.....	45, 67, 88, 139, 140, 144	L-FLXTPE-24RGB-1.....	103
L-24B2SPKT-2M-TEE-1.....	90	L-DC-SLELT30-1.....	45, 67, 88, 139, 140, 143	L-FLXTPE-27EER-1.....	87
L-24BBEXT-1M-1.....	90, 132, 165	L-DC-SLELT60-1.....	45, 67, 88, 139, 140, 143	L-FLXTPE-27RU-1.....	86
L-24BBEXT-2M-1.....	90, 132, 165	L-DCE30D-CON-1.....	45, 67, 88, 139, 140, 145	L-FLXTPE-30RH-1.....	86
L-24BBEXT-3M-1.....	90, 132, 165	L-DCE60D-CON-1.....	45, 67, 88, 139, 140, 145	L-FLXTPE-30RS-1.....	86
L-24DCELT15WP-1.....	90, 132, 147	L-DSL06-1LZ-1.....	47, 149	L-FLXTPE-30RU-1.....	86
L-24DCELT48-BL-1.....	90, 132, 147	L-DVCL-153P-WH-1.....	47, 149	L-FLXTPE-30RV-1.....	86
L-24DCELT96-1.....	90, 132, 147	L-EUL-GTD-1.....	66	L-FLXTPE-35EER-1.....	87
L-24DCH96X1-1.....	90, 132	L-EUL11W-806CAL-1.....	66	L-FLXTPE-35RU-1.....	86
L-24DCH96X1-1*.....	148	L-EUL11W-806WAL-1.....	66	L-FLXTPE-48EER-1.....	87
L-24DCH96X3-1.....	90, 132	L-EUL15W-1111CAL-1.....	66	L-FLXTPE-48RU-1.....	86
L-24DCH96X3-1*.....	148	L-EUL15W-1111WAL-1.....	66	L-FLXTPE-65EER-1.....	87
L-24VDC3INADP-BL-1.....	159, 162, 163	L-EUL3W-197CAL-1.....	66	L-FLXTPE-65RU-1.....	86
L-24VDC3INADP-WH-1.....	159, 162, 163	L-EUL3W-197WAL-1.....	66	L-FLXTPE-CRV-1.....	86
L-24XPKT-2M-BL-1.....	117	L-EUL4W-273CAL-1.....	66	L-FLXTPE-DRV-1.....	86
L-24XPKT-2M-WH-1.....	117	L-EUL4W-273WAL-1.....	66	L-FLXTPE-NRV-1.....	86
L-4P60-1.....	103, 104	L-EUL7W-502CAL-1.....	66	L-FLXTPE-WRV-1.....	86
L-ACR6M-1X1-1.....	125	L-EUL7W-502WAL-1.....	66	L-FPOC-HWB-ADP-BL-1.....	47
L-ACR6M-2X2-1.....	125	L-EULNK-120-WH-1.....	66	L-FPOC-HWB-ADP-WH-1.....	47
L-ACR6M-4X4-1.....	125	L-EULNK-15-WH-1.....	66	L-FPOC-LINKA-120-BL-1.....	46
L-ACR6M-4X8-1.....	125	L-EULNK-180-WH-1.....	66	L-FPOC-LINKA-120-WH-1.....	46
L-ACR8M-1X1-1.....	125	L-EULNK-25-WH-1.....	66	L-FPOC-LINKA-180-BL-1.....	46
L-ACR8M-2X2-1.....	125	L-EULNK-60-WH-1.....	66	L-FPOC-LINKA-180-WH-1.....	46
L-ACR8M-4X4-1.....	125	L-EXTBTB10-1.....	117	L-FPOC-LINKA-25-BL-1.....	46
L-ACR8M-4X8-1.....	125	L-EXTMP-VHB-1.....	117	L-FPOC-LINKA-25-WH-1.....	46
L-ADJTKIT-BL-1.....	44	L-FLXCOB12-27RV-1.....	88	L-FPOC-LINKA-60-BL-1.....	46
L-ADJTKIT-NI-1.....	44	L-FLXCOB12-30RV-1.....	88	L-FPOC-LINKA-60-WH-1.....	46
L-ADJTKIT-WH-1.....	44	L-FLXCOB12-35RV-1.....	88	L-HACNT-CNI-1.....	140
L-BS4PBL-1.....	103, 104	L-FLXCOB12-48RV-1.....	88	L-HACNT-WNI-1.....	140
L-CCTEXT-120-1.....	102	L-FLXCOB12-65RV-1.....	88	L-HALPHA-CNI-1.....	172
L-CCTEXT-60-1.....	102	L-FLXCOB24-27RU-1.....	90	L-HALPHA-WNI-1.....	172
L-CCTWIRE25-1.....	103	L-FLXCOB24-30RU-1.....	90	L-HFIT-CNI-1.....	172

L-HUSB2-BLNI-1.....	140	L-LED-FLXTPE-WROLL-1.....	86	L-LED-STK8-WNI-1.....	64
L-HWB-BL-T5-1.....	47, 68	L-LED-LINKD-120-1.....	67, 165	L-LED-STKDIM-TD4-1.....	64
L-HWB-BL-T5-S-1.....	47, 68	L-LED-LINKD-15-1.....	67, 165	L-LED-STKLNK-120-1.....	64
L-HWB-WH-T5-1.....	47, 68	L-LED-LINKD-180-1.....	67, 165	L-LED-STKLNK-15-1.....	64
L-HWB-WH-T5-S-1.....	47, 68	L-LED-LINKD-245-1.....	67, 165	L-LED-STKLNK-180-1.....	64
L-LED-1EB-CBL-1.....	43	L-LED-LINKD-25-1.....	67, 165	L-LED-STKLNK-25-1.....	64
L-LED-1EB-CNI-1.....	43	L-LED-LINKD-60-1.....	67, 165	L-LED-STKLNK-5-1.....	64
L-LED-1EB-CWH-1.....	43	L-LED-LINKD-8-1.....	67, 165	L-LED-STKLNK-60-1.....	64
L-LED-1EB-WBL-1.....	43	L-LED-OVLDS-**-1.....	160	L-LED-TPELNK-120-1.....	89
L-LED-1EB-WNI-1.....	43	L-LED-OVLMS-**-1.....	160	L-LED-TPELNK-15-1.....	89
L-LED-1EB-WWH-1.....	43	L-LED-OVLTD-**-1.....	160	L-LED-TPELNK-180-1.....	89
L-LED-3DSP-CBL-1.....	43	L-LED-SMP12-CNI-1.....	65	L-LED-TPELNK-25-1.....	89
L-LED-3DSP-CNI-1.....	43	L-LED-SMP12-WNI-1.....	65	L-LED-TPELNK-5-1.....	89
L-LED-3DSP-WBL-1.....	43	L-LED-SMP22-CNI-1.....	65	L-LED-TPELNK-60-1.....	89
L-LED-3DSP-WNI-1.....	43	L-LED-SMP22-WNI-1.....	65	L-LED-TPELNK-CON90-1.....	89
L-LED-AGLPR-1016CAL-1.....	66	L-LED-SMP8-CNI-1.....	65	L-LED-TPELNK-TEE-1.....	89
L-LED-AGLPR-1016WAL-1.....	66	L-LED-SMP8-WNI-1.....	65	L-LED-TPEPKT-2M-1.....	88, 117
L-LED-AGLPR-250CAL-1.....	66	L-LED-SMPLNK-120-1.....	65	L-LED-TPEPKT-2M-TEE-1.....	88
L-LED-AGLPR-250WAL-1.....	66	L-LED-SMPLNK-15-1.....	65	L-LED-WCON-BL-1.....	164, 167
L-LED-AGLPR-406CAL-1.....	66	L-LED-SMPLNK-180-1.....	65	L-LED-WCON-WH-1.....	164, 167
L-LED-AGLPR-406WAL-1.....	66	L-LED-SMPLNK-25-1.....	65	L-LT5-HWBADP-BL-1.....	68
L-LED-AGLPR-559CAL-1.....	66	L-LED-SMPLNK-5-1.....	65	L-LT5-HWBADP-WH-1.....	68
L-LED-AGLPR-711CAL-1.....	66	L-LED-SMPLNK-60-1.....	65	L-LT5-LNK120-BL-1.....	68
L-LED-AGLPR-711WAL-1.....	66	L-LED-SMPMOT-1.....	65	L-LT5-LNK120-WH-1.....	68
L-LED-AGLPR-864CAL-1.....	66	L-LED-SMPD4-1.....	65	L-LT5-LNK15-BL-1.....	68
L-LED-DIMCON-BL-1.....	162	L-LED-SQPR-1016CAL-1.....	67	L-LT5-LNK15-WH-1.....	68
L-LED-DIMCON-WH-1.....	162	L-LED-SQPR-1016WAL-1.....	67	L-LT5-LNK180-BL-1.....	68
L-LED-DIMRMT-12V8A-1.....	159	L-LED-SQPR-250CAL-1.....	67	L-LT5-LNK180-WH-1.....	68
L-LED-DIMRMT-12V8A-U-1*.....	159	L-LED-SQPR-250WAL-1.....	67	L-LT5-LNK25-BL-1.....	68
L-LED-FLXTPE-BRHO-1.....	86	L-LED-SQPR-406CAL-1.....	67	L-LT5-LNK25-WH-1.....	68
L-LED-FLXTPE-BROLL-1.....	86	L-LED-SQPR-559CAL-1.....	67	L-LT5-LNK60-BL-1.....	68
L-LED-FLXTPE-CRHO-1.....	86	L-LED-SQPR-559WAL-1.....	67	L-LT5-LNK60-WH-1.....	68
L-LED-FLXTPE-CROLL-1.....	86	L-LED-SQPR-711CAL-1.....	67	L-LT514W-904C*-1.....	68
L-LED-FLXTPE-DRHO-1.....	86	L-LED-SQPR-711WAL-1.....	67	L-LT514W-904D*-1.....	68
L-LED-FLXTPE-DROLL-1.....	86	L-LED-SQPR-864CAL-1.....	67	L-LT514W-904W*-1.....	68
L-LED-FLXTPE-NRHO-1.....	86	L-LED-SQPR-864WAL-1.....	67	L-LT518W-1204C*-1.....	68
L-LED-FLXTPE-NROLL-1.....	86	L-LED-STK12-CNI-1.....	64	L-LT518W-1204D*-1.....	68
L-LED-FLXTPE-RRHO-1.....	86	L-LED-STK12-WNI-1.....	64	L-LT518W-1204W*-1.....	68
L-LED-FLXTPE-RROLL-1.....	86	L-LED-STK22-CNI-1.....	64	L-LT525W-1504C*-1.....	68
L-LED-FLXTPE-WRHO-1.....	86	L-LED-STK22-WNI-1.....	64	L-LT525W-1504D*-1.....	68
		L-LED-STK8-CNI-1.....	64		

L-LT525W-1504W*-1.....	68	L-POC-3EQFR-WBL-1.....	44	L-SMPHO12-WNI-1.....	65
L-LT53W-267C*-1.....	68	L-POC-3EQFR-WNI-1.....	44	L-SMPHO22-CNI-1.....	65
L-LT53W-267D*-1.....	68	L-POC-3LEDSFR-CAB-1.....	42	L-SMPHO22-WNI-1.....	65
L-LT53W-267W*-1.....	68	L-POC-3LEDSFR-CBL-1.....	42	L-SMPHO8-CNI-1.....	65
L-LT54W-343C*-1.....	68	L-POC-3LEDSFR-CCH-1.....	42	L-SMPHO8-WNI-1.....	65
L-LT54W-343D*-1.....	68	L-POC-3LEDSFR-CNI-1.....	42	L-SMR-2LED-BL-1.....	44
L-LT54W-343W*-1.....	68	L-POC-3LEDSFR-CWH-1.....	42	L-SMR-2LED-NI-1.....	44
L-LT57W-571C*-1.....	68	L-POC-3LEDSFR-NBL-1.....	42	L-SP15WA-30K-1.....	132
L-LT57W-571D*-1.....	68	L-POC-3LEDSFR-NNI-1.....	42	L-SP15WA-40K-1.....	132
L-LT57W-571W*-1.....	68	L-POC-3LEDSFR-WAB-1.....	42	L-SP15WA-50K-1.....	132
L-MALE-AMP-10-1.....	167, 165	L-POC-3LEDSFR-WBL-1.....	42	L-SP15WA-65K-1.....	132
L-MFSCRWDR-1.....	166, 167	L-POC-3LEDSFR-WCH-1.....	42	L-SP3TCS-1.....	132
L-MPOC-4W-120L-CBL-1.....	45	L-POC-3LEDSFR-WNI-1.....	42	L-SP6TCS-1.....	132
L-MPOC-4W-120L-CNI-1.....	45	L-POC-3LEDSFR-WORB-1.....	42	L-SP8WA-30K-1.....	132
L-MPOC-4W-120L-CWH-1.....	45	L-POC-3LEDSFR-WWH-1.....	42	L-SP8WA-40K-1.....	132
L-MPOC-4W-120L-WBL-1.....	45	L-POC-5ADJ-C-1.....	44	L-SP8WA-50K-1.....	132
L-MPOC-4W-120L-WNI-1.....	45	L-POC-5ADJ-W-1.....	44	L-SP8WA-65K-1.....	132
L-MPOC-4W-120L-WWH-1.....	45	L-POC-5LEDSCL-CBL-1.....	43	L-SP90BTB4-1.....	132
L-MPOC-4W-120NL-CBL-1.....	45	L-POC-5LEDSCL-CNI-1.....	43	L-SPBTB10-1.....	132
L-MPOC-4W-120NL-CNI-1.....	45	L-POC-5LEDSCL-CWH-1.....	43	L-SPLNK120-1.....	132
L-MPOC-4W-120NL-CWH-1.....	45	L-POC-5LEDSCL-WBL-1.....	43	L-SPLNK25-1.....	132
L-MPOC-4W-120NL-WBL-1.....	45	L-POC-5LEDSCL-WNI-1.....	43	L-SPLNK60-1.....	132
L-MPOC-4W-120NL-WNI-1.....	45	L-POC-5LEDSCL-WORB-1.....	43	L-SPLNK8-1.....	132
L-MPOC-4W-120NL-WWH-1.....	45	L-POC-5LEDSCL-WWH-1.....	43	L-SPPKT-1M-1.....	132
L-MPOC-PKT8-BL-1.....	46	L-RDSW-1M-120-BL-1.....	46	L-SPPKT-305MM-1.....	132
L-MPOC-PKT8-WH-1.....	46	L-RDSW-1M-120-WH-1.....	46	L-STKH012-CNI-1.....	64
L-P1SCRWDR-1.....	166, 167	L-RDSW-1M-BL-1.....	163	L-STKH012-WNI-1.....	64
L-PANELKIT-DO1.....	126	L-RDSW-1M-WH-1.....	163	L-STKH022-CNI-1.....	64
L-PANELKIT-DO2.....	126	L-RDSW-2M-120-BL-1.....	46	L-STKH022-WNI-1.....	64
L-PINEXT-1.....	165, 167	L-RDSW-2M-120-WH-1.....	46	L-STKH034-CNI-1.....	64
L-POC-1LEDSFR-CBL-1.....	42	L-RDSW-2M-BL-1.....	163	L-STKH034-WNI-1.....	64
L-POC-1LEDSFR-CNI-1.....	42	L-RDSW-2M-WH-1.....	163	L-STKH08-CNI-1.....	64
L-POC-1LEDSFR-CORB-1.....	42	L-RGBCCT-RMT-1.....	102, 104	L-STKH08-WNI-1.....	64
L-POC-1LEDSFR-CWH-1.....	42	L-RGBCCT1-CREC-1.....	156	L-STX-BLNK-BL-1.....	139
L-POC-1LEDSFR-WBL-1.....	42	L-RGBCCT1-CREC-1*.....	102, 104	L-STX-BLNK-NI-1.....	139
L-POC-1LEDSFR-WNI-1.....	42	L-RGBCCT1-PREC-1.....	102, 104, 156	L-STX-LITE-CBL-1.....	139
L-POC-1LEDSFR-WORB-1.....	42	L-RGBEXT-120-1.....	104	L-STX-LITE-CNI-1.....	139
L-POC-1LEDSFR-WWH-1.....	42	L-RGBEXT-60-1.....	104	L-STX-LITE-WBL-1.....	139
L-POC-3EQFR-CBL-1.....	44	L-RGBWIRE25-1.....	104	L-STX-LITE-WNI-1.....	139
L-POC-3EQFR-CNI-1.....	44	L-SMPHO12-CNI-1.....	65		

L-STX-SKIT-CBL-1.....	139	L-TPELNK60-CCT-1.....	103	L-XFL94-SC-1.....	116
L-STX-SKIT-CNI-1.....	139	L-TPELNK60-RGB-1.....	104	L-XLNLK-120-**-1.....	117
L-STX-SKIT-WBL-1.....	139	L-TPEPKT-2IN-1.....	88, 117	L-XLNLK-15-**-1.....	117
L-STX-SKIT-WNI-1.....	139	L-TPEPKT-2IN-RGB-1.....	103	L-XLNLK-180-**-1.....	117
L-TOOLKIT-1.....	167	L-TPEPKT-2M-RGB-1.....	103	L-XLNLK-25-**-1.....	117
L-TPE-BTB-CCT-1.....	102	L-TRANS-MNT-BL-1.....	142, 143, 144, 145, 146, 167	L-XLNLK-60-**-1.....	117
L-TPE-BTB-RGB-1.....	104	L-TR55-UCLP-M-1.....	68	L-XPKT-2IN-BL-1.....	117
L-TPEPKT-2IN-CCT-1.....	102	L-TS2-72-1.....	46, 163	L-XPKT-2IN-WH-1.....	117
L-TPEPKT-2M-CCT-1.....	102	L-VHBTPPE-1134-1.....	165, 167	L-XPKT-2M-BL-1.....	117
L-TPE6-12IN-**-K-1.....	125	L-WCLP-WH-1.....	167	L-XPKT-2M-WH-1.....	117
L-TPE6-24IN-**-K-1.....	125	L-WLD-1REC-1.....	150, 151, 152, 153	L-XREC72-BL-1.....	116
L-TPE6-48IN-**-K-1.....	125	L-WLD-1RND-BL-1.....	152	L-XREC72-SC-1.....	116
L-TPE6-96IN-**-K-1.....	125	L-WLD-1RND-NI-1.....	152	L-XREC94-BL-1.....	116
L-TPELED-24RGB-1.....	103	L-WLD-1WAL-**-1.....	151	L-XREC94-SC-1.....	116
L-TPELED-27HER-1.....	87	L-WLD-2WAL-**-1.....	151	L-XRECCBOYY-XX-1.....	161
L-TPELED-27SER-1.....	87	L-WLD-3RMT-BL-1.....	153	L-XRECDIMA-XX-1.....	161
L-TPELED-30HER-1.....	87	L-WLD-CCT-WH-1.....	102, 104, 157	L-XRECECP-BL-1.....	116
L-TPELED-30SER-1.....	87	L-WLD-RGB-WH-1.....	102, 104, 157	L-XRECECP-GY-1.....	116
L-TPELED-35HER-1.....	87	L-WLDS-BL-1.....	155	L-XRM42-155-1.....	117
L-TPELED-35SER-1.....	87	L-WLDS-NI-1.....	155	L-XRND-UCLP-1.....	117
L-TPELED-48HER-1.....	87	L-WLDSREC-1.....	154	L-XRND72-BL-1.....	116
L-TPELED-48SER-1.....	87	L-WM5-BL-1.....	164	L-XRND72-SC-1.....	116
L-TPELED-65HER-1.....	87	L-WM5-BR-1.....	164	L-XRND72-SC-1.....	116
L-TPELED-65SER-1.....	87	L-WM5-WH-1.....	164	L-XRND72-SC-1.....	116
L-TPELED2-27VER-1.....	87	L-X**-DIFF-CL-1.....	116	L-XRND72-SC-1.....	116
L-TPELED2-30VER-1.....	87	L-X**-DIFF-FR-1.....	116	L-XRND72-SC-1.....	116
L-TPELED2-35VER-1.....	87	L-X**-DIFF-MLK-1.....	116	L-XRND72-SC-1.....	116
L-TPELED2-48VER-1.....	87	L-XANG72-**-1.....	116	L-XRND72-SC-1.....	116
L-TPELED2-65VER-1.....	87	L-XANG72-SC-1.....	116	L-XRND72-SC-1.....	116
L-TPELNK-BTB-1.....	89	L-XANGCBOYY-XX-1.....	161	L-XRND72-SC-1.....	116
L-TPELNK120-CCT-1.....	103	L-XANGDIMA-XX-1.....	161	L-XRND72-SC-1.....	116
L-TPELNK120-RGB-1.....	104	L-XANGCECP-**-1.....	116	L-XRND72-SC-1.....	116
L-TPELNK15-CCT-1.....	103	L-XANGCECP-GY-1.....	116	L-XRND72-SC-1.....	116
L-TPELNK15-RGB-1.....	104	L-XCRV72-**-1.....	116	L-XRND72-SC-1.....	116
L-TPELNK180-CCT-1.....	103	L-XCRV72-SC-1.....	116	L-XRND72-SC-1.....	116
L-TPELNK180-RGB-1.....	104	L-XCRVCBOYY-XX-1.....	161	L-XRND72-SC-1.....	116
L-TPELNK25-CCT-1.....	103	L-XCRVDIMA-XX-1.....	161	L-XRND72-SC-1.....	116
L-TPELNK25-RGB-1.....	104	L-XCRVECP-**-1.....	116	L-XRND72-SC-1.....	116
L-TPELNK5-CCT-1.....	103	L-XCRVECP-GY-1.....	116	L-XRND72-SC-1.....	116
L-TPELNK5-RGB-1.....	104	L-XFL72-SC-1.....	116	L-XRND72-SC-1.....	116









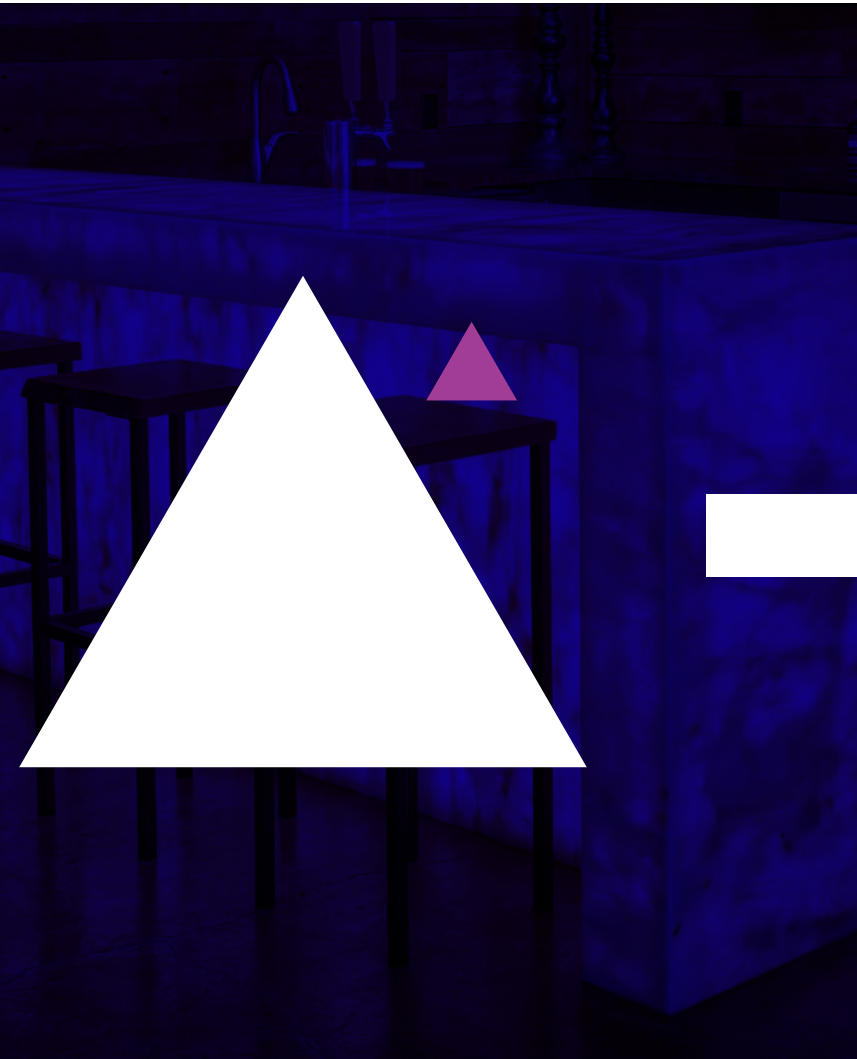

tresco
lighting

1-800-227-1171 | trescolighting.com

