

1W/Ft.

You can apply this twistable and flexible LED strip to a wide range of contoured designs. The low profile, low heat and high output of this product makes it ideal for use in confined applications.

Installation is simple, with either peel-and-stick adhesive or screw mount.

FlexBar

LED Lights you can stick

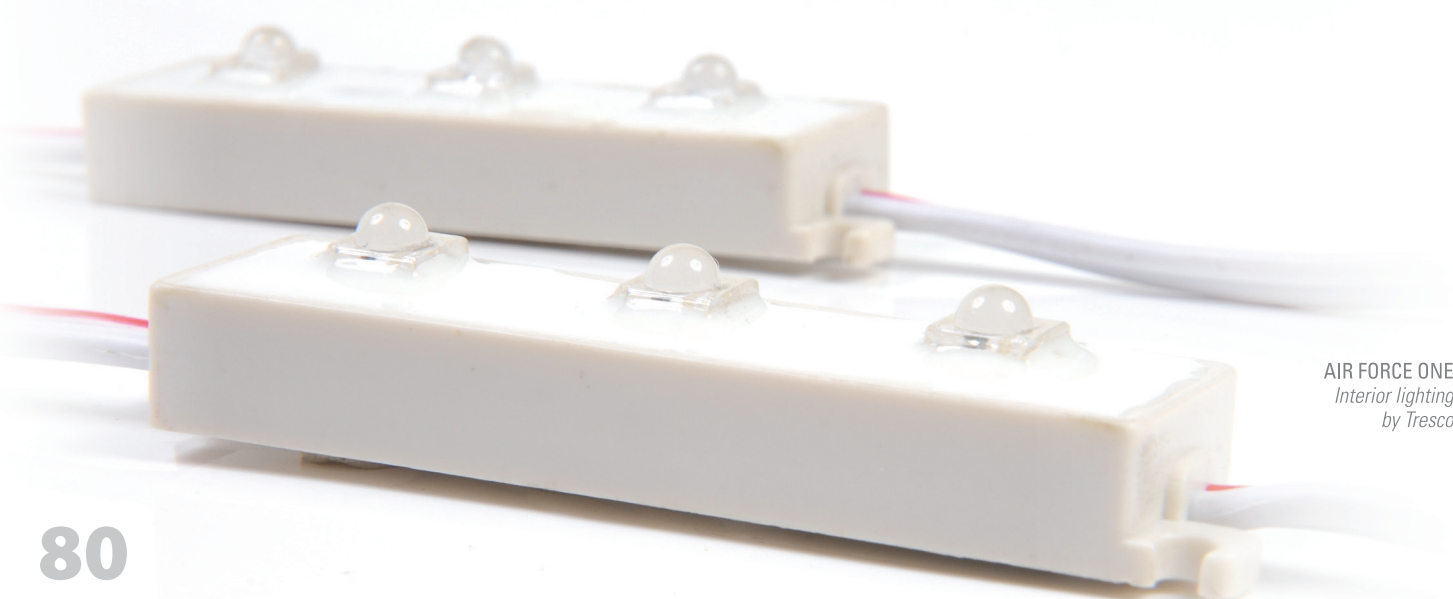

AIR FORCE ONE
Interior lighting
by Tresco



Features:

- Avg. rated life: 50,000 hrs.
- Available up to 100' ft. rolls
- 1W per foot
- Linkable/cuttable
- Strong adhesive backing or screw mount
- Waterproof
- Dimensions:
L: 2.75" x H: .375" x W: .75"

Applications:

- Toe kick
- Soffit
- Cove lighting
- Back lighting
- Accent lighting
- Edge lighting

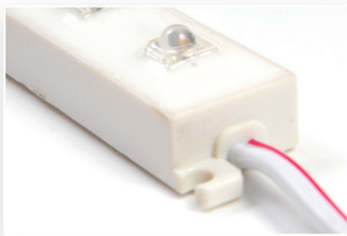

Mounting Tab

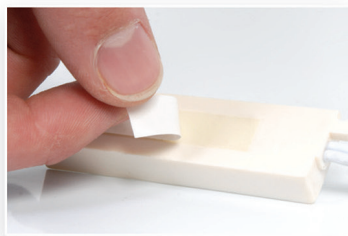

Adhesive Backing



Link Section to Section

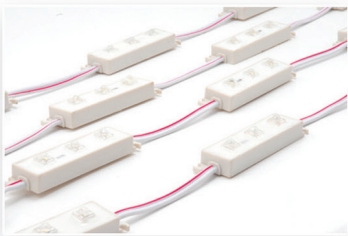

3" from module to module



ck virtually anywhere



Required Items

FlexBar LED Modules

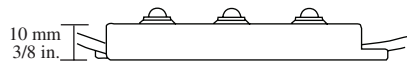

Part #	Description	Suggested List
L-LED-FLXBAR-WROLL25-1	25' 3000K FlexBar Roll	\$725.00
L-LED-FLXBAR-CROLL25-1	25' 4800K FlexBar Roll	\$725.00
L-LED-FLXBAR-DROLL25-1	25' 6500K FlexBar Roll	\$725.00
L-LED-FLXBAR-GROLL25-1	25' Green FlexBar Roll	\$725.00
L-LED-FLXBAR-RROLL25-1	25' Red FlexBar Roll	\$725.00
L-LED-FLXBAR-BROLL25-1	25' Blue FlexBar Roll	\$725.00

50,000 End of Life Hours 7.6cm (3 in.) Length Per Module. Also available in 50', and 100' rolls.
Maximum continuous run 50 feet to prevent voltage drop.

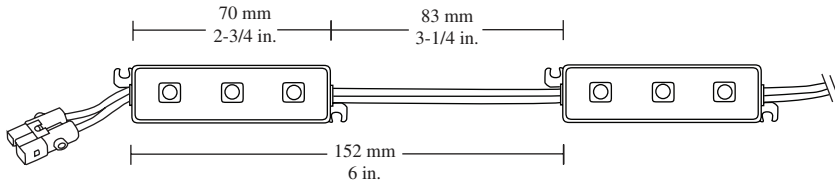

DC Power Supply - 18W

Electronic. Powers up to 4.6 m (15 ft.) of FlexBar.

Part #	Description	Suggested List
L-DC-ELT18-CON-1	18W 12VDC Power Supply w/6 Snap Mounting Block	\$61.20

Mounting Block and Power Cord are included with each Power Supply. Powers up to 4.6 m (15 ft.) of FlexBar.

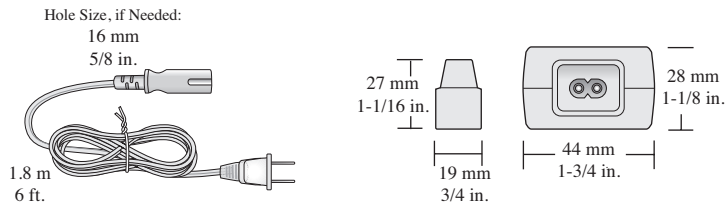
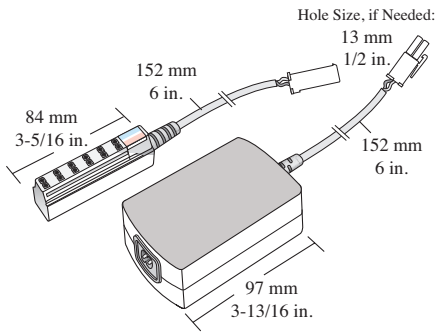

DC Power Supply - 60W

Electronic. Powers up to 15.2 m (50 ft.) of FlexBar.

Part #	Description	Suggested List
L-DC-ELT60-CON-1	60W 12VDC Power Supply w/6 Snap Mounting Block	\$73.80

Mounting Block and Power Cord are included with each Power Supply. Powers up to 15.2 m (50 ft.) of FlexBar.

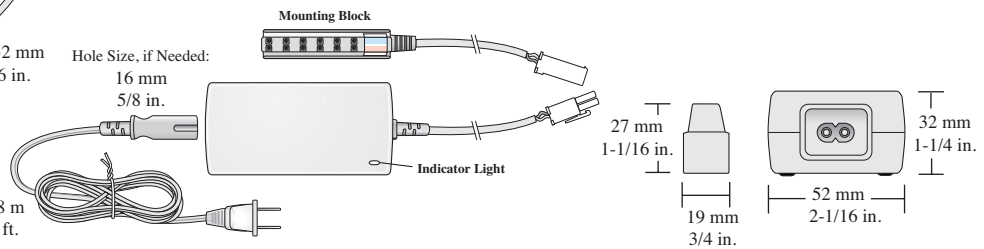
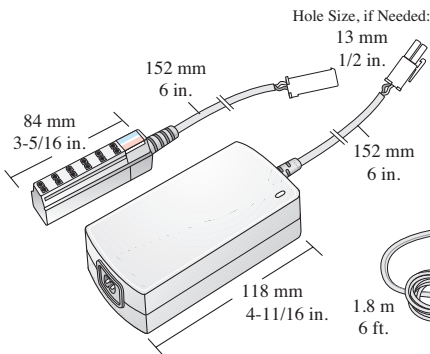

Power Kit/Starter Cord

Part #	Description	Suggested List
L-LED-PKT-FLXBAR-WH-1	FlexBar Starter Lead, 12VDC, 2m (79")	\$21.75

Maximum 15.2 m (50 ft.) of FlexBar per Starter Cord.

A Power Kit is used to build a Starter Cord of proper length. A Kit includes 2 m (79") of 18-gauge wire, two Barrel Connectors and a male AMP® connector.

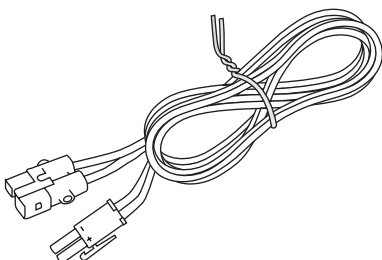

All product dimensions and specifications are subject to change without prior notice.



Optional Items

Touch On/Off Switch

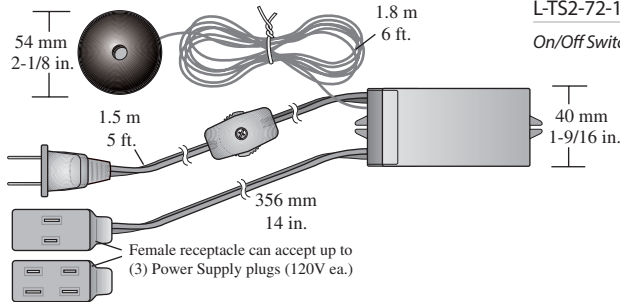

Part #	Description	Suggested List
L-TS2-72-1	Touch On/Off w/Cord And Touch Pad. Black.	\$48.45

On/Off Switch touch pad attaches to surface with adhesive backing. Power Supply plugs into On/Off Switch.

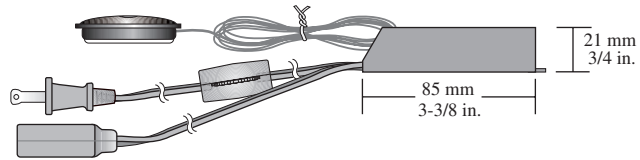

Round Switch - 12V

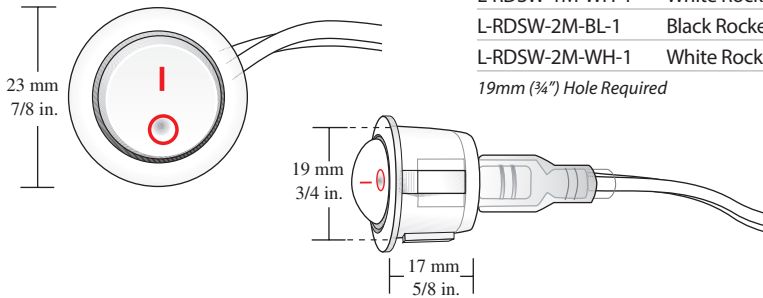

Part #	Description	Suggested List
L-RDSW-1M-BL-1	Black Rocker Switch w/1m (39") Lead, 12VAC/DC	\$16.40
L-RDSW-1M-WH-1	White Rocker Switch w/1m (39") Lead, 12VAC/DC	\$16.40
L-RDSW-2M-BL-1	Black Rocker Switch w/2m (79") Lead, 12VAC/DC	\$18.40
L-RDSW-2M-WH-1	White Rocker Switch w/2m (79") Lead, 12VAC/DC	\$18.40

19mm (3/4") Hole Required

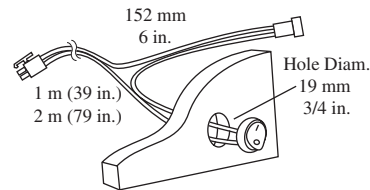

Roll Switch - 120V

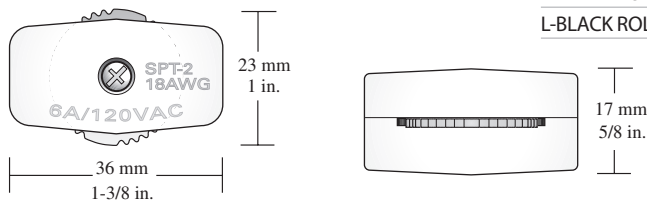

Part #	Description	Suggested List
L-WHITE ROLL SWITCH-1	120V White Roll Switch	\$2.45
L-BLACK ROLL SWITCH-1	120V Black Roll Switch	\$2.45

Remote Control LED Dimmer - 12V

w/ 2 Remote Controls

Part #	Description	Suggested List
L-LED-DIMRMT-12V8A-1	LED Dedicated Remote Control Dimmer, 12VDC 96W	\$80.05
L-LED-DIMRMT-12V8A-U-1	LED Universal Remote Control Dimmer, 12VDC 96W	\$80.05

Both models of the Remote Control LED Dimmer provide on/off power and dim lights from 1%–100%. The standard Remote Control independently controls one specific Dimmer in a room with other Dimmers. The Universal Remote Control (U) controls multiple Dimmers in a room.

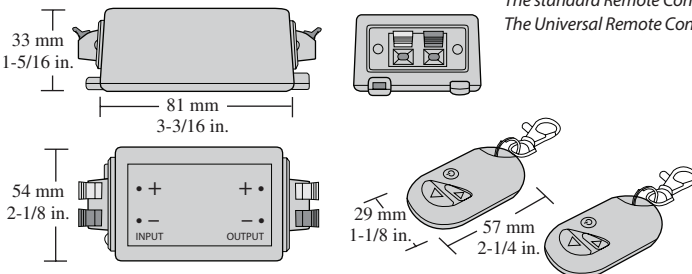

All product dimensions and specifications are subject to change without prior notice.

FLEXBAR LED
FLEXIBLE LIGHTING

Optional Items

Manual Rotary Dimmer

Part #	Description	Suggested List
L-LED-DIMCON-BL-1	LED Black Inline Rotary Dimmer, 12VDC 48W	\$50.05
L-LED-DIMCON-WH-1	LED White Inline Rotary Dimmer, 12VDC 48W	\$50.05

The Manual Rotary Dimmer provides on/off power and dims lights from 1%–100%.

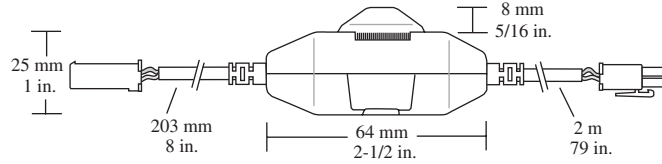
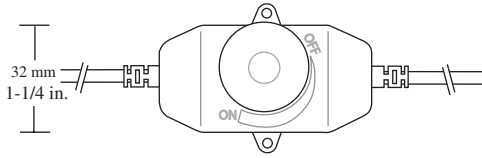

AMP® Connector

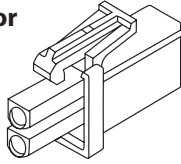

Part #	Description	Suggested List
L-MALE AMP	AMP® Connector for Light Fixture	\$10.15

AMP® Connector is included with each Light Fixture.

Extension Cord

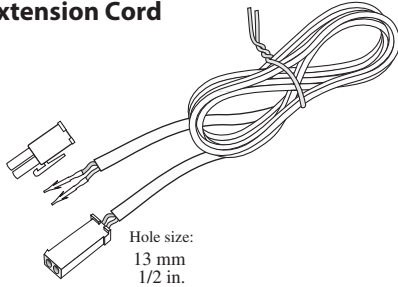

Part #	Description	Suggested List
L-LED-LINKD-15-1	15cm (6") 12VDC Starter/Link/Extension Cord	\$4.05
L-LED-LINKD-25-1	25cm (10") 12VDC Starter/Link/Extension Cord	\$5.95
L-LED-LINKD-60-1	60cm (24") 12VDC Starter/Link/Extension Cord	\$6.65
L-LED-LINKD-120-1	120cm (48") 12VDC Starter/Link/Extension Cord	\$8.25
L-LED-LINKD-180-1	180cm (72") 12VDC Starter/Link/Extension Cord	\$10.00

Used to extend Power Kit/Starter Cord.

D.I.Y. Jumper Kit

Requires Jumper Wire and (4) Barrel Connectors to build one DIY Jumper Cord to appropriate length.

Part #	Description	Suggested List
L-LED-SPT2-WH-1	10' SPT2 Wire (needed to create linking cords)	\$22.35

Use in conjunction with Barrel Connectors to make Jumpers or Links to length as needed.

Part #	Description	Suggested List
L-LED-WCON-WH-1	DIY Connectors (pack of 10, needed to create link cords)	\$52.80

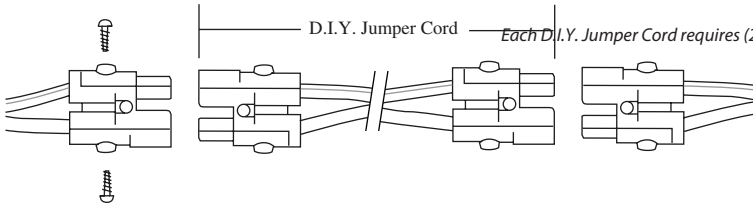

Magnet Switch Kit - 12V

Part #	Description	Suggested List
L-AUSW-MAG-BR-1	Brown Automatic Magnet Door Switch, 20W Max	\$27.55
L-AUSW-MAG-WH-1	White Automatic Magnet Door Switch, 20W Max	\$27.55

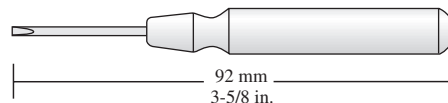
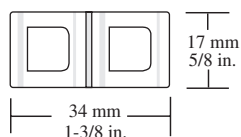
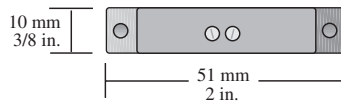

All product dimensions and specifications are subject to change without prior notice.



Optional Items

Control Modules

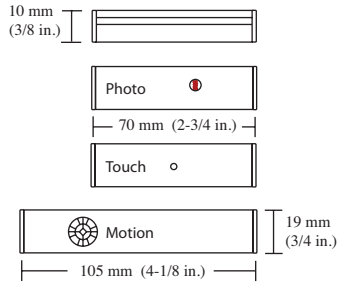

Part #	Description	Suggested List
L-LED-SMPMOT-1	27W SimpLED Inline Motion Sensor	\$70.75
L-LED-SMPPHOTO-1	27W SimpLED Inline Photo Sensor	\$45.40
L-LED-SMPTD4-1	27W SimpLED Inline Touch Dimmer	\$55.10
L-LED-SMPADP-5-1	5cm 12VDC SimpLED Adaptor	\$3.65
L-LED-SMPADP-15-1	15cm 12VDC SimpLED Adaptor	\$3.95
L-LED-SMPADP-25-1	25cm 12VDC SimpLED Adaptor	\$4.45
L-LED-SMPADP-60-1	60cm 12VDC SimpLED Adaptor	\$6.15
L-LED-SMPADP-120-1	120cm 12VDC SimpLED Adaptor	\$7.85
L-LED-SMPADP-180-1	180cm 12VDC SimpLED Adaptor	\$9.35

Controls up to 25 feet of FlexBar Lights.



FLEXBAR LED
FLEXIBLE LIGHTING

1.5/3W/Ft.

FlexTape

The most flexible
LED lights on earth



SPECS

- Height: 2.25 mm
- Width: 10 mm
- 1.5 W/foot (standard) 3 W/foot (H.O.)
- 40' max per trans (standard), 20' (H.O.)
- 20' max continuous run (standard), 16.4' (H.O)

Features:

- Avg. rated life: 25,000 Hrs
- Available in: Standard (1.5 W/ft) High Output (3 W/ft)
- Sold by the roll (20' roll, 16.4' HO roll)
- Low-Heat
- Strong 3M™ adhesive backing

Applications:

- Cove lighting
- Back lighting
- Accent lighting
- Edge lighting
- Toe Kick
- Soffit

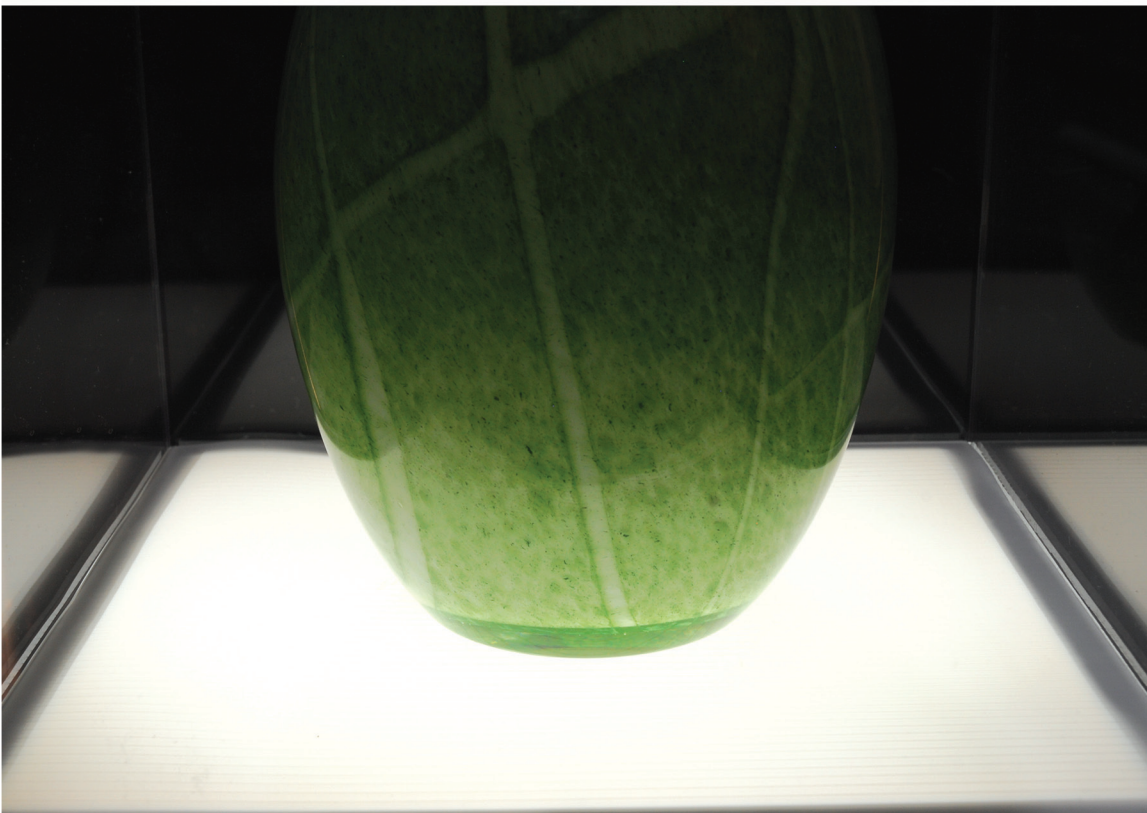

Museum piece under glass and lit by FlexTape from beneath



Peel & Stick It — Virtually Anywhere!

Starter Leads:



L-LED-TPEPKT-2M

Straight starter



L-LED-TPEPKT-2M-TEE

T Starter



Connectors:



L-LED-TPELNK-TEE

T-Link



L-LED-TPELNK-X X=LENGTH

Linking Cord 6" - 72"



L-LED-TPELNK-CON90

Right Angle

HIGH OUTPUT:

Spacing between diodes center to center 7mm



Cuttable every 1"

STANDARD OUTPUT:

Spacing between diodes center to center 16mm



Cuttable every 2"



*Tape back adhesive
No soldering-
Easy screw-on fittings*

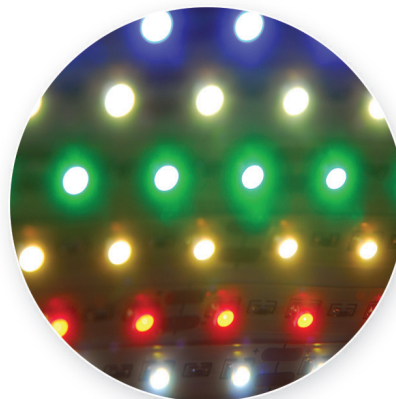

Available colors:

*Warm White, Cool White,
Daylight, Red, Green & Blue*





Required Items

FlexTape LED

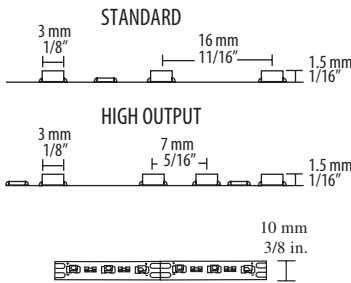
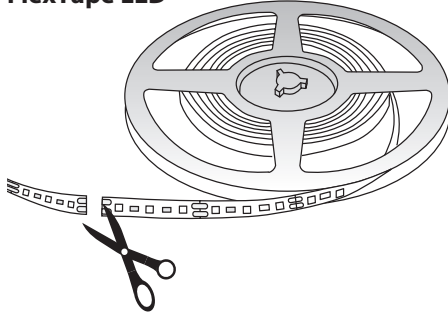

Part #	Description	Suggested List
L-LED-FLXTPE-WROLL-1	20' 27400 FlexTape Roll	\$348.00
L-LED-FLXTPE-CROLL-1	20' 4800K FlexTape Roll	\$348.00
L-LED-FLXTPE-DRROLL-1	20' 6500K FlexTape Roll	\$348.00
L-LED-FLXTPE-GROLL-1	20' Green FlexTape Roll	\$348.00
L-LED-FLXTPE-RRROLL-1	20' Red FlexTape Roll	\$348.00
L-LED-FLXTPE-BROLL-1	20' Blue FlexTape Roll	\$348.00

Maximum continuous run is 6 m (20 ft.). Maximum per Power Supply is 12 m (40 ft.). Mounts with adhesive backing. Cuttable every 49 mm (2 in.).

Part #	Description	Suggested List
L-LED-FLXTPE-WRHO-1	16.4' 27400 High Output FlexTape Roll	\$385.70
L-LED-FLXTPE-CRHO-1	16.4' 4800K High Output FlexTape Roll	\$385.70
L-LED-FLXTPE-DRHO-1	16.4' 6500K High Output FlexTape Roll	\$385.70
L-LED-FLXTPE-RRHO-1	16.4' Red High Output FlexTape Roll	\$385.70
L-LED-FLXTPE-BRHO-1	16.4' Blue High Output FlexTape Roll	\$385.70

Maximum continuous run is 5 m (16.4 ft.). Maximum per Power Supply is 6 m (20 ft.). Mounts with adhesive backing. Cuttable every 25 mm (1 in.).

DC Power Supply - 60W

Electronic. Powers up to 12.1 m (40 ft.) of FlexTape.

Part #	Description	Suggested List
L-DC-ELT60-CON-1	60W 12VDC Power Supply w/6 Snap Mounting Block	\$73.80

Maximum FlexTape from a single Power Supply is 6 m (20 ft.) for standard output, 6 m (20 ft.) for H.O. Mounting Block and Power Cord are included with each Power Supply.

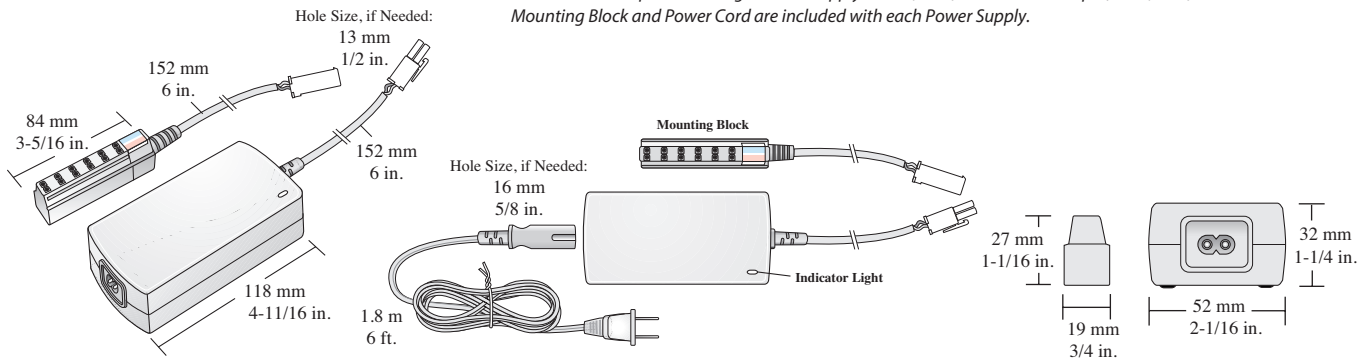

Starter Cord

Straight feed

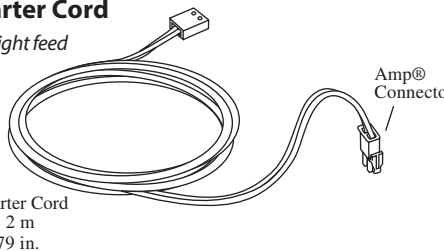

Part #	Description	Suggested List
L-LED-TPEPKT-2M-1	2m (79") FlexTape Straight Starter Lead	\$8.40

16 mm (5/8 in.) Hole Required
Maximum linear run of FlexTape from one Starter Cord is 6 m (20 ft.) and 5 m (16.4 ft.) for H.O.

Tee Starter Cord

Split feed

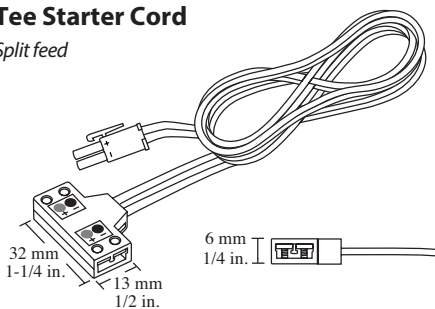

Part #	Description	Suggested List
L-LED-TPEPKT-2M-TEE-1	2m (79") FlexTape Tee Starter Lead	\$13.35

20' Maximum per starter (HO), 40' Standard. 16.4' Maximum continuous run (HO), 20' Standard
Maximum linear run cannot be deleted from one side of Tee and added to other, i.e. cannot have 12 m (40 ft.) on one side only. 16 mm (5/8 in.) Hole Required

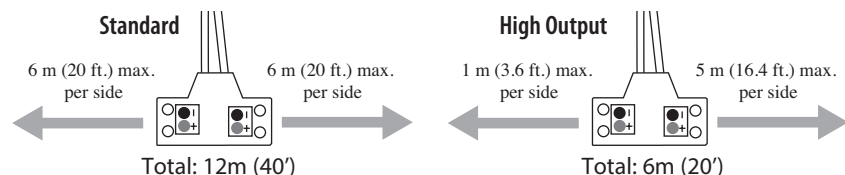

Optional Items

Touch On/Off Switch

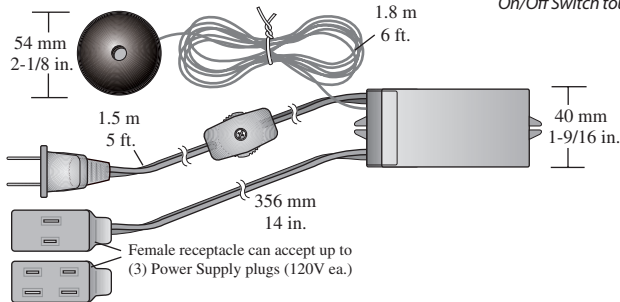

Female receptacle can accept up to (3) Power Supply plugs (120V ea.)

Part #	Description	Suggested List
L-TS2-72-1	Touch On/Off w/Cord And Touch Pad. Black.	\$48.45

On/Off Switch touch pad attaches to surface with adhesive backing. Power Supply plugs into On/Off Switch.

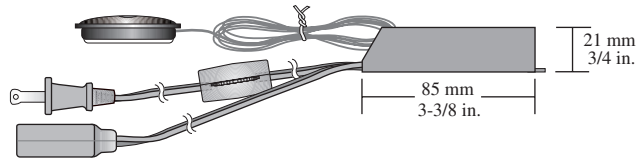

Round Switch - 12V

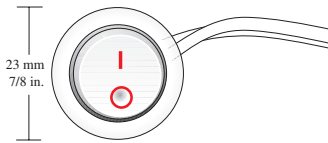

Part #	Description	Suggested List
L-RDSW-1M-BL-1	Black Rocker Switch w/1m (39") Lead, 12VAC/DC	\$16.40
L-RDSW-1M-WH-1	White Rocker Switch w/1m (39") Lead, 12VAC/DC	\$16.40
L-RDSW-2M-BL-1	Black Rocker Switch w/2m (79") Lead, 12VAC/DC	\$18.40
L-RDSW-2M-WH-1	White Rocker Switch w/2m (79") Lead, 12VAC/DC	\$18.40

19mm (3/4") Hole Required

More specifications available on pages 340-341.

Roll Switch - 120V

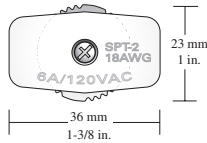

Part #	Description	Suggested List
L-WHITE ROLL SWITCH-1	120V White Roll Switch	\$2.45
L-BLACK ROLL SWITCH-1	120V Black Roll Switch	\$2.45

More specifications available on pages 340-341.

Remote Control LED Dimmer - 12V

w/ 2 Remote Controls

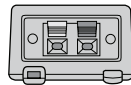
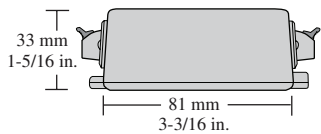

Both models of the Remote Control LED Dimmer provide on/off power and dim lights from 1%–100%. The standard Remote Control independently controls one specific Dimmer in a room with other Dimmers. The Universal Remote Control (U) controls multiple Dimmers in a room.

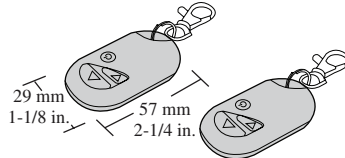
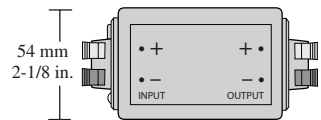

Part #	Description	Suggested List
L-LED-DIMRMT-12V8A-1	LED Dedicated Remote Control Dimmer, 12VDC 96W	\$80.05
L-LED-DIMRMT-12V8A-U-1	LED Universal Remote Control Dimmer, 12VDC 96W	\$80.05

Manual Rotary Dimmer

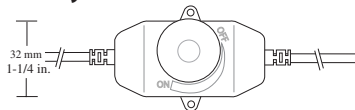

Part #	Description	Suggested List
L-LED-DIMCON-BL-1	LED Black Inline Rotary Dimmer, 12VDC 48W	\$50.05
L-LED-DIMCON-WH-1	LED White Inline Rotary Dimmer, 12VDC 48W	\$50.05

The Manual Rotary Dimmer provides on/off power and dims lights from 1%–100%.

More specifications available on pages 340-341.

AMP® Connector

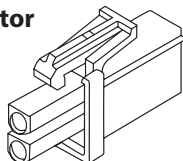

Part #	Description	Suggested List
L-MALE AMP	AMP® Connector for Light Fixture	\$10.15

AMP® Connector is included with each Light Fixture.

All product dimensions and specifications are subject to change without prior notice.

Optional Items

Tee Connector

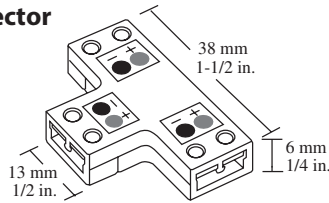

Part #	Description	Suggested List
L-LED-TPELNK-TEE-1	Tee Link Connector	\$5.35

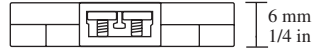

Right Angle Connector

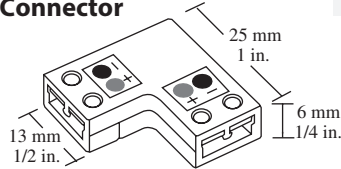

Part #	Description	Suggested List
L-LED-TPELNK-CON90-1	90 Degree Link Connector	\$4.65

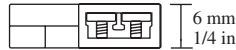

Jumper Cord

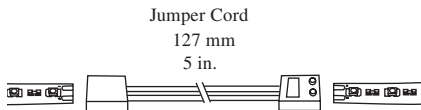

Part #	Description	Suggested List
L-LED-TPELNK-5-1	5cm (2") FlexTape Link Cord	\$4.80
L-LED-TPELNK-15-1	15cm (6") FlexTape Link Cord	\$5.35
L-LED-TPELNK-25-1	25cm (10") FlexTape Link Cord	\$5.95
L-LED-TPELNK-60-1	60cm (24") FlexTape Link Cord	\$6.80
L-LED-TPELNK-120-1	120cm (48") FlexTape Link Cord	\$7.10
L-LED-TPELNK-180-1	180cm (72") FlexTape Link Cord	\$7.85

Positive and negative contacts on FlexTape and FlexConnects should match-up, to maintain proper polarity.

Extension Cord

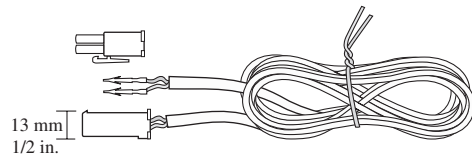

Used to extend Power Kit/Starter Cord.

Part #	Description	Suggested List
L-LED-LINKD-15-1	15cm (6") 12VDC Starter/Link/Extension Cord	\$4.05
L-LED-LINKD-25-1	25cm (10") 12VDC Starter/Link/Extension Cord	\$5.95
L-LED-LINKD-60-1	60cm (24") 12VDC Starter/Link/Extension Cord	\$6.65
L-LED-LINKD-120-1	120cm (48") 12VDC Starter/Link/Extension Cord	\$8.25
L-LED-LINKD-180-1	180cm (72") 12VDC Starter/Link/Extension Cord	\$10.00

Magnet Switch Kit - 12V

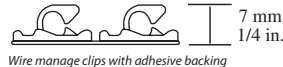
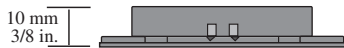
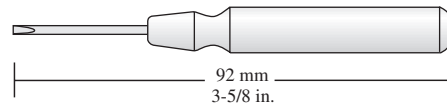
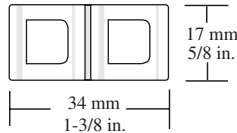
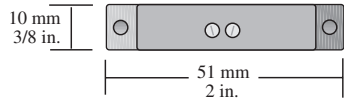

Wire manage clips with adhesive backing

Part #	Description	Suggested List
L-AUSW-MAG-BR-1	Brown Automatic Magnet Door Switch, 20W Max	\$27.55
L-AUSW-MAG-WH-1	White Automatic Magnet Door Switch, 20W Max	\$27.55

Control Modules

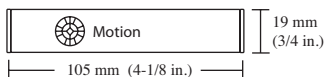
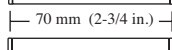
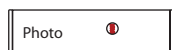
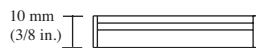

Part #	Description	Suggested List
L-LED-SMPMOT-1	27W SimpLED Inline Motion Sensor	\$70.75
L-LED-SMPPHOTO-1	27W SimpLED Inline Photo Sensor	\$45.40
L-LED-SMPTD4-1	27W SimpLED Inline Touch Dimmer	\$55.10
L-LED-SMPADP-5-1	5cm 12VDC SimpLED Adaptor	\$3.65
L-LED-SMPADP-15-1	15cm 12VDC SimpLED Adaptor	\$3.95
L-LED-SMPADP-25-1	25cm 12VDC SimpLED Adaptor	\$4.45
L-LED-SMPADP-60-1	60cm 12VDC SimpLED Adaptor	\$6.15
L-LED-SMPADP-120-1	120cm 12VDC SimpLED Adaptor	\$7.85
L-LED-SMPADP-180-1	180cm 12VDC SimpLED Adaptor	\$9.35

Controls up to 18 feet of standard FlexTape and 9 feet of High Output FlexTape.

