

The patented Elli V combines premium LEDs with an angled design that allows for tight corner mounting. It fits easily over glue or staples commonly found in cabinet and casework construction. High-output, wide-angle LEDs and fixture-to-fixture linking capability make for perfect, even illumination.



3.6W/Ft.

Tresco

ELI™ V

LED made easy with
HIGH-OUTPUT strips



Tresco®

E11i V

LED made easy with HIGH-OUTPUT strips

Linkable up to 12' continuous
(16' max per Power Supply)

4"

- Linking distance is 4"

- There will be no darkened areas between fixtures if unit is installed at height of 18" from surface

Features:

- Instant on instant brightness
- Available in 6 lengths (11, 17, 23, 29, 35, and 41")
- Aluminum finish (custom finish w/minimum)
- 50,000-hour life
- Linkable up to 12' continuous (16' max per power supply)
- 120° wide-angle flood LED
- 3500K, 4800K color temperatures
- 3.6 Watts per foot

EASY INSTALL MOUNTING HOLE

SPECS

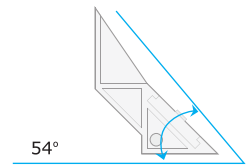
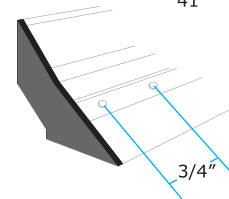
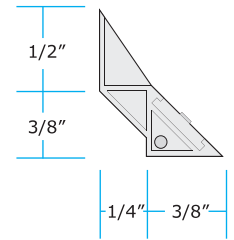
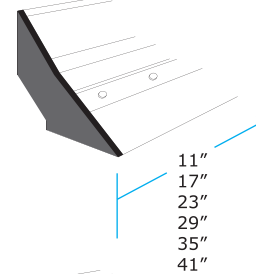

LOW PROFILE 1/2"

3500K (W)
3.6W per ft.
4800K (C)

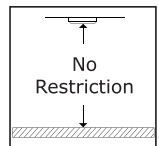
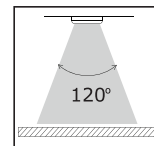

Tresco

E11 iTM 2

easy to conceal
easy to install

*Linkable up to 12' continuous
(16' max per power supply)*

- Linking distance is 4"
- There will be no darkened areas between fixtures if unit is installed at height of 18" from surface





Features:

- 50,000-hour life
- Available in six lengths: 11, 17, 23, 29, 35, and 41"
- Aluminum finish
- Linkable up to 12' continuous
- 120° wide-angle flood
- 3500K, 4800K color temperatures
- Quick U-Clip mounting

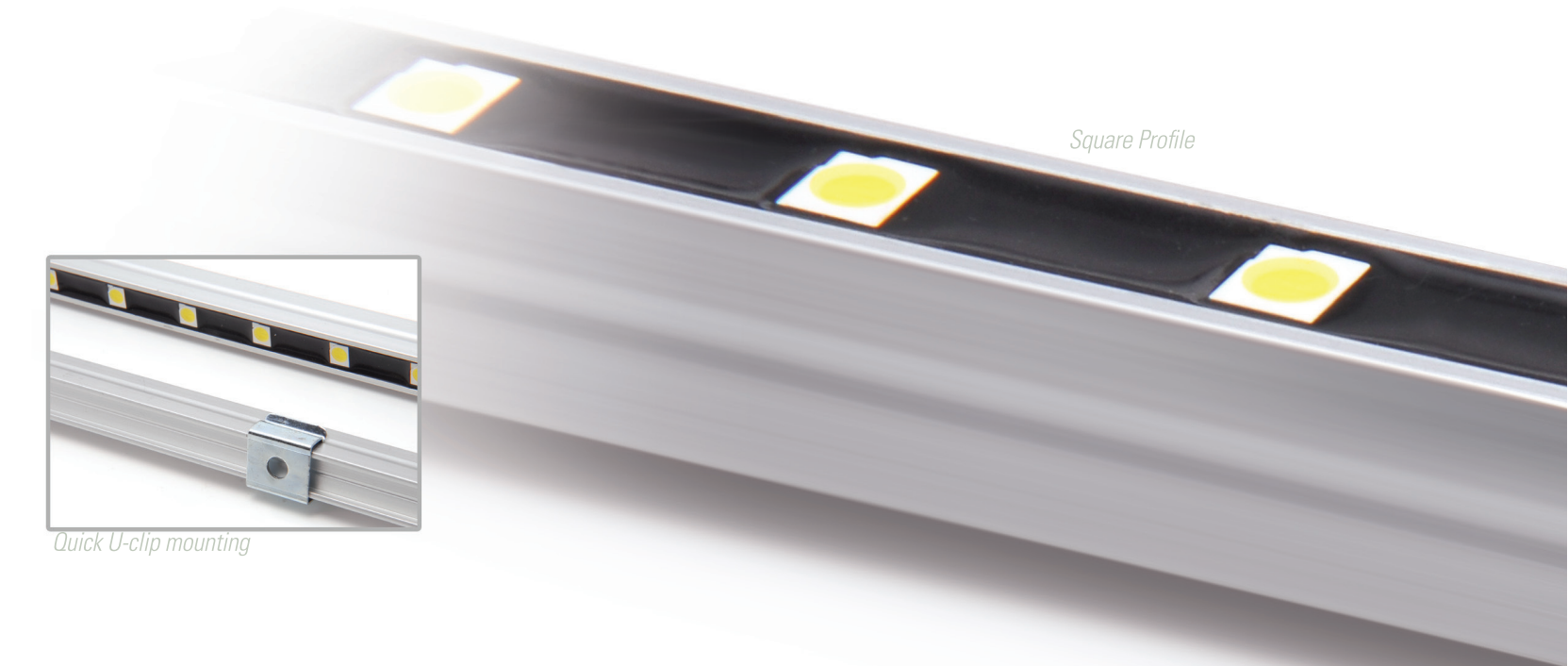

Square Profile

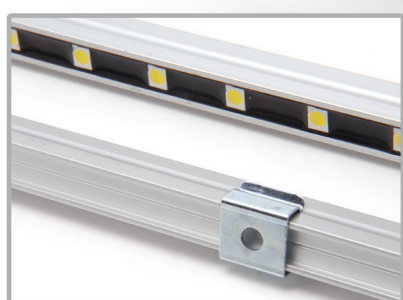

Quick U-clip mounting

SPECS

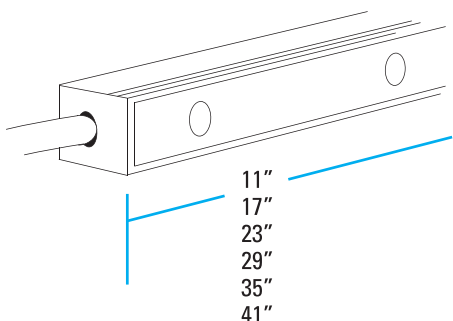
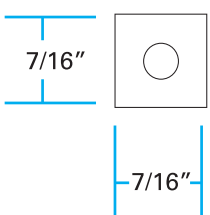

3500K (warm)		
3.6W per ft.		
4800K (cool)		



Required Items

Light Fixture - Elli V

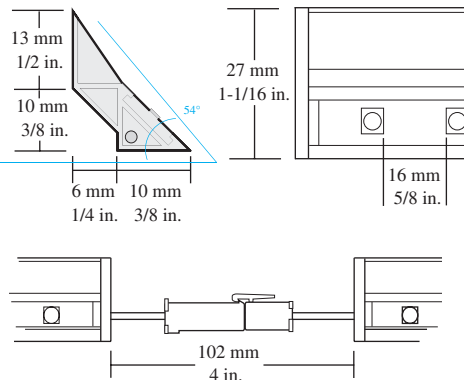

Part #	Description (size with end caps)	Suggested List
L-LED-AGLPR-250WAL-1	279mm (11") Elli V LED, 3500K, Aluminum	\$122.95
L-LED-AGLPR-406WAL-1	432mm (17") Elli V LED, 3500K, Aluminum	\$181.40
L-LED-AGLPR-559WAL-1	584mm (23") Elli V LED, 3500K, Aluminum	\$236.65
L-LED-AGLPR-711WAL-1	737mm (29") Elli V LED, 3500K, Aluminum	\$289.00
L-LED-AGLPR-864WAL-1	889mm (35") Elli V LED, 3500K, Aluminum	\$347.40
L-LED-AGLPR-1016WAL-1	1041mm (41") Elli V LED, 3500K, Aluminum	\$399.60
L-LED-AGLPR-250CAL-1	279mm (11") Elli V LED, 4800K, Aluminum	\$122.95
L-LED-AGLPR-406CAL-1	432mm (17") Elli V LED, 4800K, Aluminum	\$181.40
L-LED-AGLPR-559CAL-1	584mm (23") Elli V LED, 4800K, Aluminum	\$236.65
L-LED-AGLPR-711CAL-1	737mm (29") Elli V LED, 4800K, Aluminum	\$289.00
L-LED-AGLPR-864CAL-1	889mm (35") Elli V LED, 4800K, Aluminum	\$347.40
L-LED-AGLPR-1016CAL-1	1041mm (41") Elli V LED, 4800K, Aluminum	\$399.60

50,000 Useful Life Hours
Maximum continuous run 12 feet to prevent voltage drop. 16 feet maximum per Power Supply.

Light Fixture - Elli 2

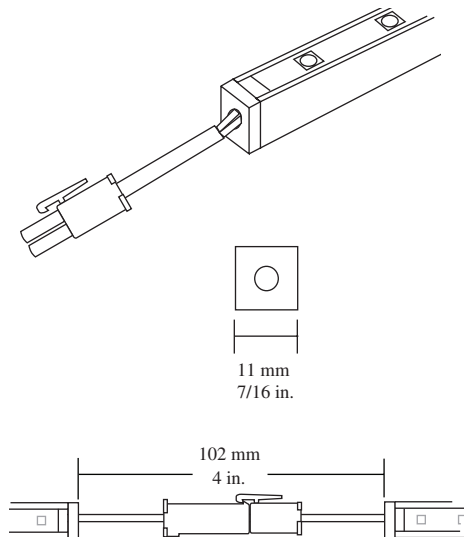

Part #	Description (size with end caps)	Suggested List
L-LED-SQPR-250WAL-1	279mm (11") Elli 2 LED, 3500K, Aluminum	\$122.95
L-LED-SQPR-406WAL-1	432mm (17") Elli 2 LED, 3500K, Aluminum	\$181.40
L-LED-SQPR-559WAL-1	584mm (23") Elli 2 LED, 3500K, Aluminum	\$236.65
L-LED-SQPR-711WAL-1	737mm (29") Elli 2 LED, 3500K, Aluminum	\$289.00
L-LED-SQPR-864WAL-1	889mm (35") Elli 2 LED, 3500K, Aluminum	\$347.40
L-LED-SQPR-1016WAL-1	1041mm (41") Elli 2 LED, 3500K, Aluminum	\$399.60
L-LED-SQPR-250CAL-1	279mm (11") Elli 2 LED, 4800K, Aluminum	\$122.95
L-LED-SQPR-406CAL-1	432mm (17") Elli 2 LED, 4800K, Aluminum	\$181.40
L-LED-SQPR-559CAL-1	584mm (23") Elli 2 LED, 4800K, Aluminum	\$236.65
L-LED-SQPR-711CAL-1	737mm (29") Elli 2 LED, 4800K, Aluminum	\$289.00
L-LED-SQPR-864CAL-1	889mm (35") Elli 2 LED, 4800K, Aluminum	\$347.40
L-LED-SQPR-1016CAL-1	1041mm (41") Elli 2 LED, 4800K, Aluminum	\$399.60

50,000 Useful Life Hours
Maximum continuous run 12 feet to prevent voltage drop. 16 feet maximum per Power Supply.

DC Power Supply - 60W

Electronic.

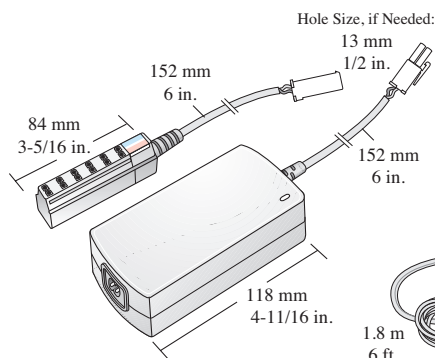

Part #	Description	Suggested List
L-DC-ELT60-CON-1	60W 12VDC Power Supply w/6 Snap Mounting Block	\$73.80

Dimmable on trailing edge (12V side).
Mounting Block and Power Cord are included with each Power Supply.

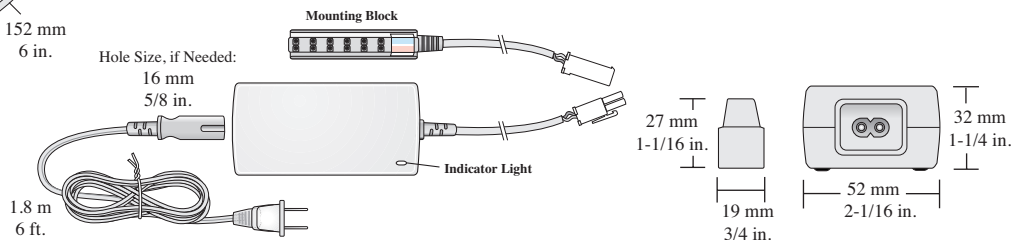

All product dimensions and specifications are subject to change without prior notice.

ELLI™ HIGH OUTPUT LED STRIP LIGHTING

Required Items

Starter Cord

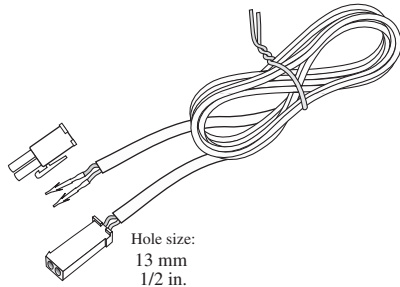

Hole size:
13 mm
1/2 in.

Part #	Description	Suggested List
L-LED-LINKD-15-1	15cm (6") 12VDC Starter/Link/Extension Cord	\$4.05
L-LED-LINKD-25-1	25cm (10") 12VDC Starter/Link/Extension Cord	\$5.95
L-LED-LINKD-60-1	60cm (24") 12VDC Starter/Link/Extension Cord	\$6.65
L-LED-LINKD-120-1	120cm (48") 12VDC Starter/Link/Extension Cord	\$8.25
L-LED-LINKD-180-1	180cm (72") 12VDC Starter/Link/Extension Cord	\$10.00

Required to connect run of Lights to Power Supply. Purchased separately.
13 mm (1/2 in.) Hole Required

Optional Items

Touch On/Off Switch

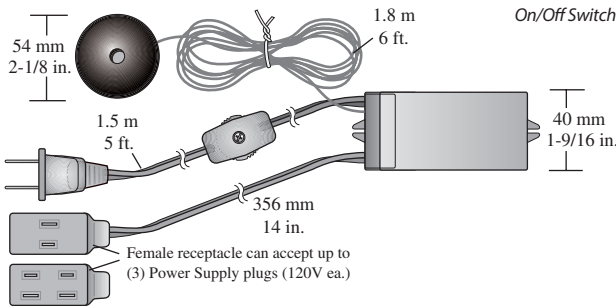

Part #	Description	Suggested List
L-TS2-72-1	Touch On/Off w/Cord And Touch Pad. Black.	\$48.45

On/Off Switch touch pad attaches to surface with adhesive backing. Power Supply plugs into On/Off Switch.

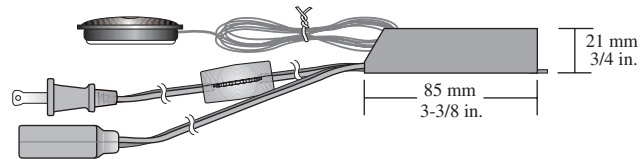

Round Switch - 12V

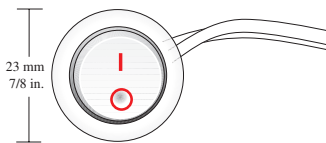

Part #	Description	Suggested List
L-RDSW-1M-BL-1	Black Rocker Switch w/1m (39") Lead, 12VAC/DC	\$16.40
L-RDSW-1M-WH-1	White Rocker Switch w/1m (39") Lead, 12VAC/DC	\$16.40
L-RDSW-2M-BL-1	Black Rocker Switch w/2m (79") Lead, 12VAC/DC	\$18.40
L-RDSW-2M-WH-1	White Rocker Switch w/2m (79") Lead, 12VAC/DC	\$18.40

19mm (3/4") Hole Required

More specifications available on pages 340-341.

Roll Switch - 120V

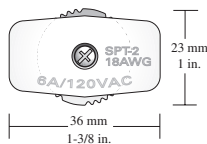

Part #	Description	Suggested List
L-WHITE ROLL SWITCH-1	120V White Roll Switch	\$2.45
L-BLACK ROLL SWITCH-1	120V Black Roll Switch	\$2.45

More specifications available on pages 340-341.

Remote Control LED Dimmer - 12V

w/ 2 Remote Controls

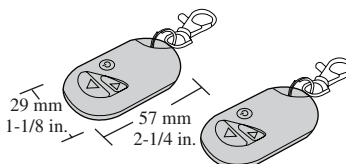
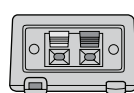
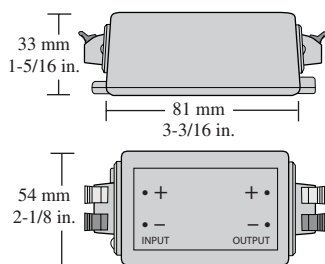

Part #	Description	Suggested List
L-LED-DIMRMT-12V8A-1	LED Dedicated Remote Control Dimmer, 12VDC 96W	\$80.05
L-LED-DIMRMT-12V8A-U-1	LED Universal Remote Control Dimmer, 12VDC 96W	\$80.05

Both models of the Remote Control LED Dimmer provide on/off power and dim lights from 1%–100%.
The standard Remote Control independently controls one specific Dimmer in a room with other Dimmers.
The Universal Remote Control (U) controls multiple Dimmers in a room.

All product dimensions and specifications are subject to change without prior notice.

Optional Items

Manual Rotary Dimmer

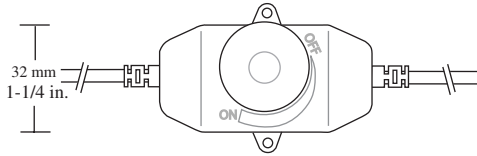

Part #	Description	Suggested List
--------	-------------	----------------

L-LED-DIMCON-BL-1	LED Black Inline Rotary Dimmer, 12VDC 48W	\$50.05
L-LED-DIMCON-WH-1	LED White Inline Rotary Dimmer, 12VDC 48W	\$50.05

The Manual Rotary Dimmer provides on/off power and dims lights from 1%–100%.

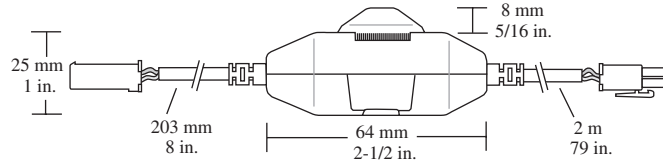

AMP® Connector

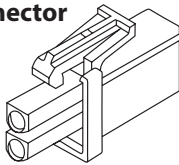

Part #	Description	Suggested List
--------	-------------	----------------

L-MALE AMP	AMP® Connector for Light Fixture	\$10.15
------------	----------------------------------	---------

AMP® Connector is included with each Light Fixture.

Extension Cord

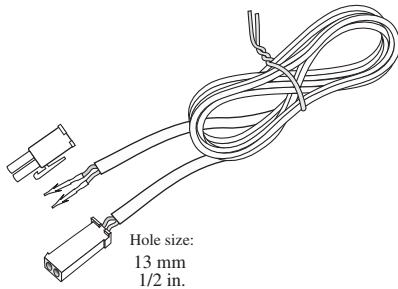

Part #	Description	Suggested List
--------	-------------	----------------

L-LED-LINKD-15-1	15cm (6") 12VDC Starter/Link/Extension Cord	\$4.05
L-LED-LINKD-25-1	25cm (10") 12VDC Starter/Link/Extension Cord	\$5.95
L-LED-LINKD-60-1	60cm (24") 12VDC Starter/Link/Extension Cord	\$6.65
L-LED-LINKD-120-1	120cm (48") 12VDC Starter/Link/Extension Cord	\$8.25
L-LED-LINKD-180-1	180cm (72") 12VDC Starter/Link/Extension Cord	\$10.00

Used to link fixture to fixture when desired spacing is greater than 4".

Magnet Switch Kit - 12V

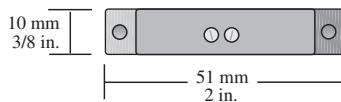

Part #	Description	Suggested List
--------	-------------	----------------

L-AUSW-MAG-BR-1	Brown Automatic Magnet Door Switch, 20W Max	\$27.55
L-AUSW-MAG-WH-1	White Automatic Magnet Door Switch, 20W Max	\$27.55

More specifications available on pages 340-341.

Control Modules

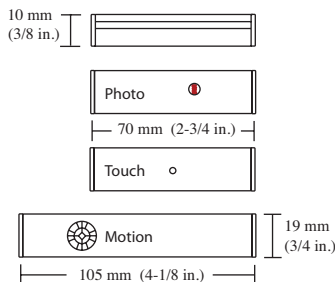

Part #	Description	Suggested List
--------	-------------	----------------

L-LED-SMPMOT-1	27W SimpLED Inline Motion Sensor	\$70.75
L-LED-SMPPHOTO-1	27W SimpLED Inline Photo Sensor	\$45.40
L-LED-SMPTD4-1	27W SimpLED Inline Touch Dimmer	\$55.10
L-LED-SMPADP-5-1	5cm 12VDC SimpLED Adaptor	\$3.65
L-LED-SMPADP-15-1	15cm 12VDC SimpLED Adaptor	\$3.95
L-LED-SMPADP-25-1	25cm 12VDC SimpLED Adaptor	\$4.45
L-LED-SMPADP-60-1	60cm 12VDC SimpLED Adaptor	\$6.15
L-LED-SMPADP-120-1	120cm 12VDC SimpLED Adaptor	\$7.85
L-LED-SMPADP-180-1	180cm 12VDC SimpLED Adaptor	\$9.35

Controls up to 7 feet of Elli™ Lights.

All product dimensions and specifications are subject to change without prior notice.

ELLI™ HIGH OUTPUT LED STRIP LIGHTING