

Features

- 32^{63/64}" (838) x 22^{1/64}" (559) x 7" (178) top mount kitchen sink.
- Double equal compartments.
- 20 gauge 304 stainless steel.
- Center drain locations.
- Brushed finish.
- 19mm radius corners.
- 3mm sound deadening pads.
- Fits 36" base cabinet width.

Components

Product includes:
Cutout Template
Installation Hardware
Installation Instructions

Options

- 2210R Covered Sink Strainer
- 4010 Covered Disposer Strainer
- TMTK1 Magnetic Tool Set

Warranty

- Lifetime Limited Warranty

Specified Model

Model	STDE33227
Overall Dimensions	L32 ^{63/64} " x W22 ^{1/64} " x D7" 838 x 559 x 178
Bowl Dimensions (Left)	L14 ^{1/64} " x W15 ^{63/64} " x D7" 356 x 406 x 178
Bowl Dimensions (Right)	L14 ^{1/64} " x W15 ^{63/64} " x D7" 356 x 406 x 178
Drain holes:	3 ^{5/8} " (92mm)
Shipping Weight	20 lbs.
Material	20 gauge 304 stainless steel
Installation	counter top mounted
Required	template, included

To Be Specified:

see back for configurations available for this sink

	Faucet Hole Drillings
<input type="checkbox"/>	1 Hole
<input type="checkbox"/>	2 Holes
<input type="checkbox"/>	2 Holes - MR2
<input type="checkbox"/>	3 Holes
<input type="checkbox"/>	4 Holes
<input type="checkbox"/>	5 Holes

Codes/Standards

ASME A112.19.3/CSA B45.4

Notes

Install this product according to the installation instructions.

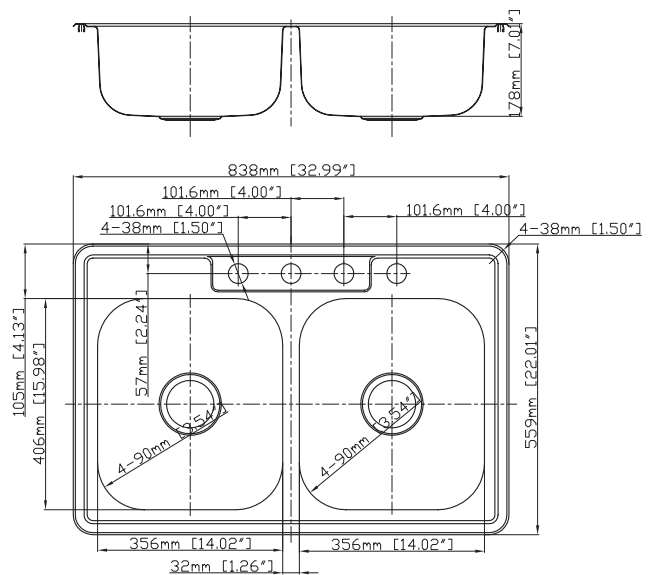

Faucet Hole Configurations available for this sink model

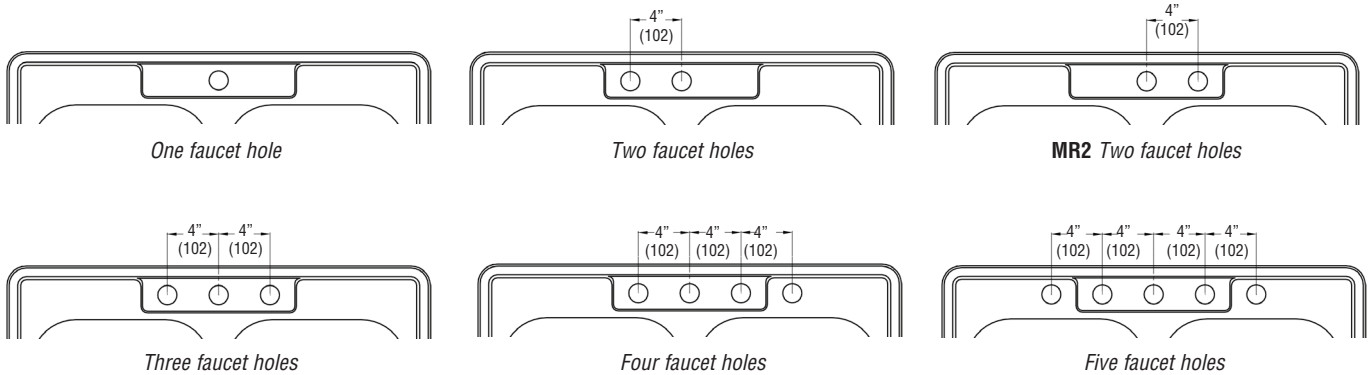

Optional Accessories

2210R Covered Flip Top Sink Strainer.

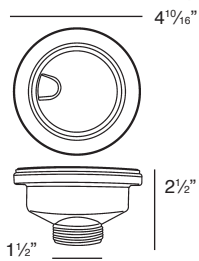

Water drains easily when cover is in place. Cover flips up with easy touch. Polypropylene housing. Fits standard 3 1/2" opening.

2310 Remote Covered Flip Top Sink Strainer.

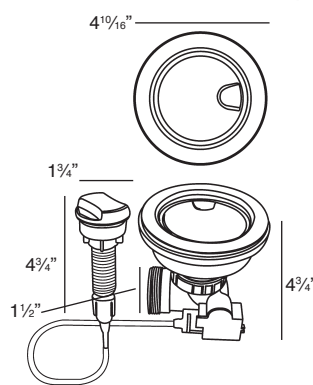

Turn the remote knob to open and close drain. Water drains easily when cover is in place. Cover flips up with easy touch. Polypropylene housing. Fits standard 3 1/2" opening. 1 3/8" hole required in countertop for remote installation. Remote cable 25 1/2" L.

4010 Covered Flip Top Disposer Strainer.

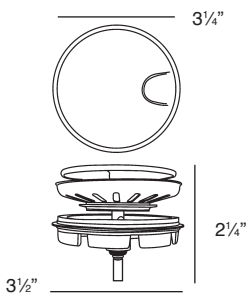

Water drains easily when cover is in place. Cover flips up with easy touch. Polypropylene housing. Top mount installation for 3 1/2" opening.