

Features

- 32⁶³/₆₄" (838) x 22¹/₆₄" (559) x 8" (203) top mount kitchen sink.
- Double equal compartments.
- 18 gauge 304 stainless steel.
- Rear center drain location.
- Brushed finish.
- Superior undercoating for added sound insulation.
- 3mm sound deadening pads on all 4 sink sides and bottom. Up to 3 times heavier than competitive models.
- Fits 36" base cabinet width.

Components

- Product includes:
Cutout Template
Installation Hardware
Installation Instructions

shown with Transolid
T3540-PC faucet

Options

- TSGC33222 Stainless Steel Bottom Sink Grid Set
- TCBC1516 Bamboo Cutting Board
- 2210R Covered Sink Strainer
- 4010 Covered Disposer Strainer

Warranty

- Lifetime Limited Warranty

Specified Model

Model	CTDE33228
Overall Dimensions	L32 ⁶³ / ₆₄ " x W22 ¹ / ₆₄ " x D8" 838 x 559 x 203
Bowl Dimensions (Left)	L14 ¹ / ₆₄ " x W15 ⁶³ / ₆₄ " x D8" 356 x 406 x 203
Bowl Dimensions (Right)	L14 ¹ / ₆₄ " x W15 ⁶³ / ₆₄ " x D8" 356 x 406 x 203
Drain holes:	3 ⁵ / ₈ " (92mm)
Shipping Weight	23 lbs.
Material	18 gauge 304 stainless steel
Installation	counter top mounted
Required	template, included

To Be Specified:

see back for configurations available for this sink

	Faucet Hole Drillings
<input type="checkbox"/>	1 Hole
<input type="checkbox"/>	2 Holes - ML2
<input type="checkbox"/>	2 Holes - MR2
<input type="checkbox"/>	3 Holes
<input type="checkbox"/>	4 Holes
<input type="checkbox"/>	5 Holes

Codes/Standards

ASME A112.19.3/CSA B45.4

Notes

Install this product according to the installation instructions.

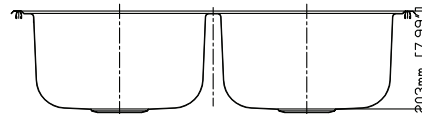
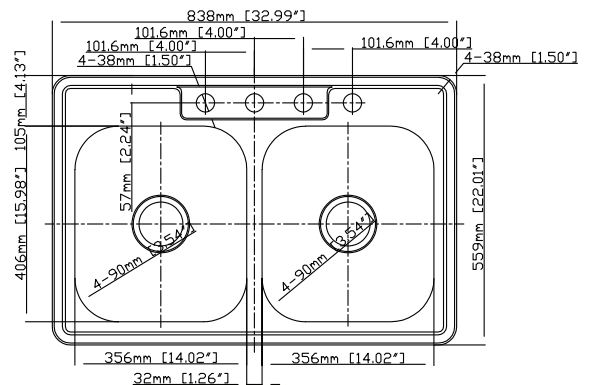

Faucet Hole Configurations available for this sink model

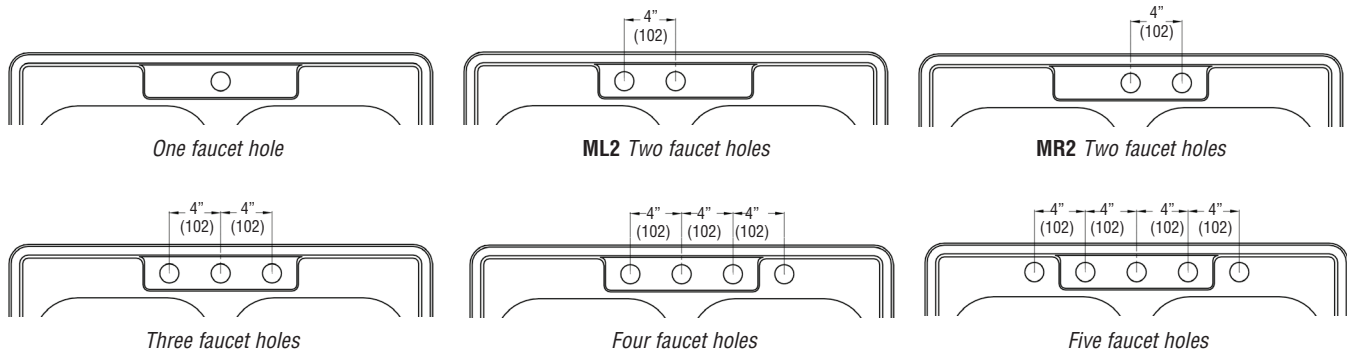

Optional Accessories

TSGC33222 Bottom Sink Grid Set

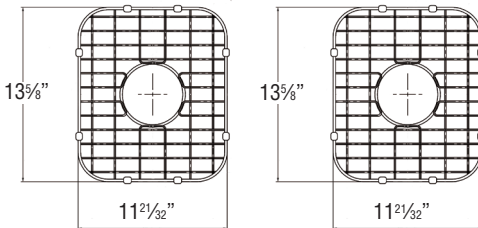

2210R Covered Flip Top Sink Strainer.

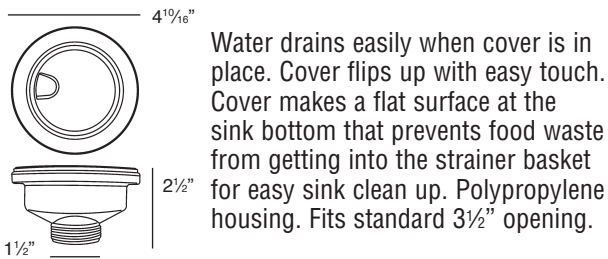

Water drains easily when cover is in place. Cover flips up with easy touch. Cover makes a flat surface at the sink bottom that prevents food waste from getting into the strainer basket for easy sink clean up. Polypropylene housing. Fits standard 3 1/2" opening.

2310 Remote Covered Flip Top Sink Strainer.

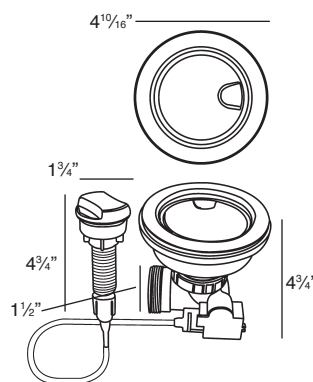

Turn the remote knob to open and close drain. Water drains easily when cover is in place. Cover flips up with easy touch. Cover makes a flat surface at the sink bottom that prevents food waste from getting into the strainer basket for easy sink clean up. Polypropylene housing. Fits standard 3 1/2" opening. 1 3/8" hole required in countertop for remote installation. Remote cable 25 1/2" L.

4010 Covered Flip Top Disposer Strainer.

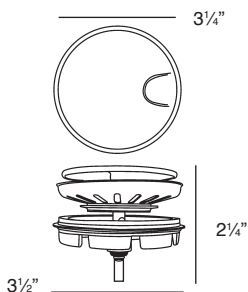

Water drains easily when cover is in place. Cover flips up with easy touch. Polypropylene housing. Top mount installation for 3 1/2" opening.