

Bathtub Installation Instructions

(Acrylic)

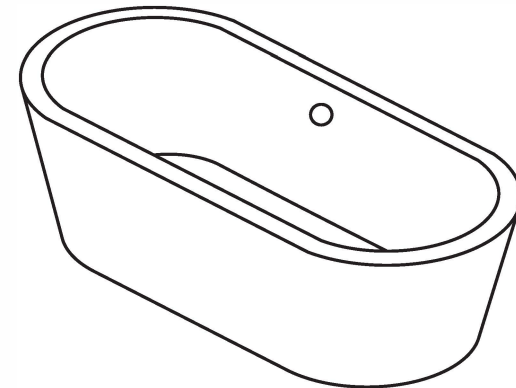

As the product style is continuously updated, the actual product may not match the illustration, but the basic principle is the same.
After the installation is completed, this manual must be kept by the customer.



This bathtub manual must be given to the user along with the bathtub.
This warranty is only valid if installed by a professional installer following the steps in the instructions.



Precautions Before and After Installation



1. Please check the product for completeness and possible damage immediately after receiving the goods (see the parts list on page 02 for details).
2. Inform your dealer immediately if any damage occurs, we are not responsible for any damage incurred during or after installation.
3. Please check the door width before starting work, and whether the purchased bathtub can safely pass through the door of the room where the bathtub will be installed.
4. Be careful not to use hoses or mounting parts when handling the tub.
5. Do not lay any circuit under the bathtub. Please use a suitable protective cover during installation to avoid damage to the product surface or internal blockage due to falling debris or dust during installation.
6. Check the waterproofness of the bathtub. After connecting the water supply and drainage pipes, you must test the water in the bathtub to check whether there is any water leakage.
7. Special precautions: When cleaning tiles, make sure that no ammonia or similar aggressive cleaning agents come into contact with the installed parts.

Note: We reserves the right to modify or change this product without prior notice.

Parts List

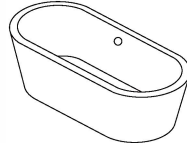
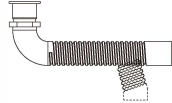

After unpacking, please confirm the parts and quantity according to the following contents.

Product Name	Bathtub	Drain Fittings	Installation Instructions
Quantity	1	1	1
Schematic Diagram			

Installation Requirements

A. Required tools

- Wrench
- Scale
- Spirit level
- Safety shoes
- Square ruler
- Screwdriver
- Pliers
- Utility knife

B. Required Materials

- Plumbing putty
- Wall protector
- Sealing silicone

Installation Steps

! 1. Bathtub installation preparation

Please ensure a space 100mm larger than the product size of the bathtub, and determine the installation position of the bathtub.

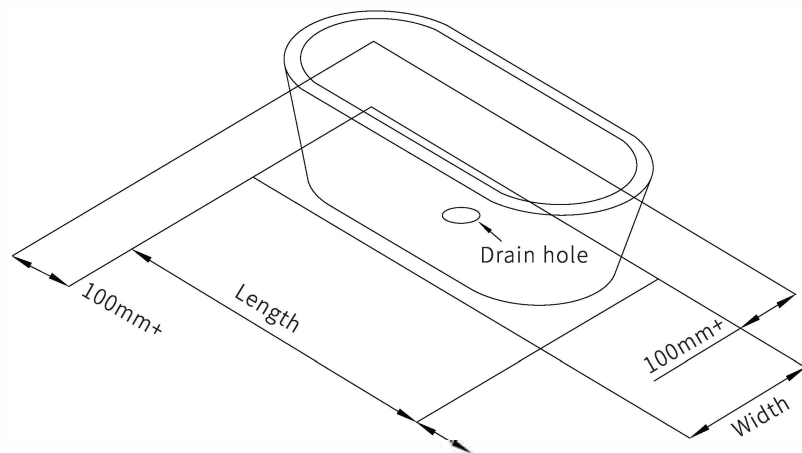

! 2. Bathtub installation

Place the bathtub upside down on the upholstery as shown, and adjust the bathtub feet 2~3mm above the edge of the bathtub (make sure the weight-bearing is on the bathtub feet).

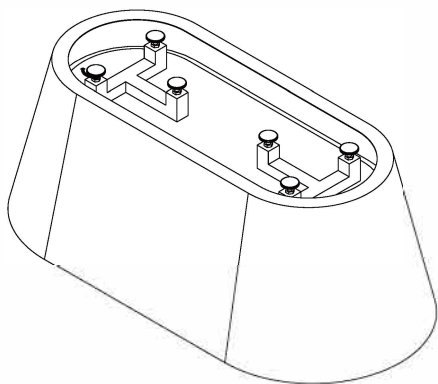

03

Installation Steps

! 3. Connecting the drainage pipe

Please connect the bathtub downer to the drain. (After installation, fill with water to check if the seal is good)

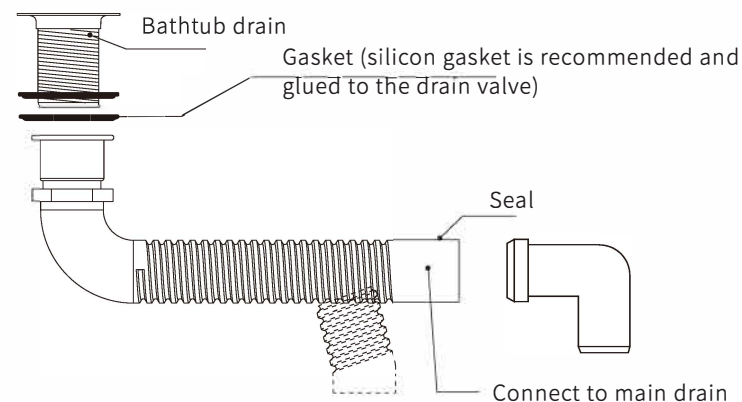

! 4. Adjust Stability

To prevent uneven ground, fine-tune the bathtub feet until the overall level of the bathtub, and then conduct a full water test to ensure the drainage seal.

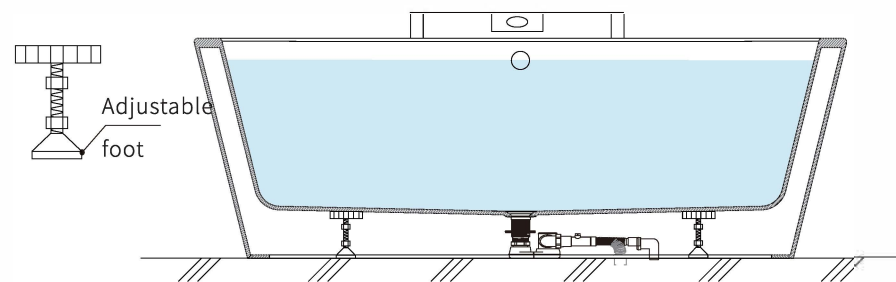

04

Installation Steps

! 5. Fix the bathtub

Use silica gel to fix the base on the ground, and wait for it to cure for 24 hours before proceeding to other constructions.

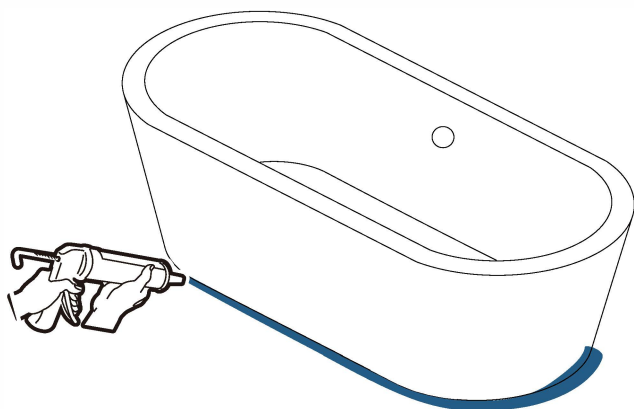

! 6. Clean up

After the installation, please clean the floor, and finally clean the bathtub with a rag dipped in a neutral detergent.