

# CEILING FAN

## Assembly Instructions



### CAUTION

- Inspect the wire insulation for any cuts, abrasions, or exposed copper that may have resulted during shipping. If there is a defect in the wire, do not attempt installation.
- To reduce the risk of fire, electric shock, or personal injury, mount the fan to an outlet box marked acceptable for fan support using the screws provided with the outlet box. An outlet box commonly used for the support of lighting fixtures may not be acceptable for fan support and may need to be replaced.
- Before starting installation of this fixture or removal of a previous fixture, disconnect the power by turning off the circuit breaker or by removing the fuse at the fuse box.
- Make sure that the fan voltage (120) is compatible with your own electrical system.

### TOOLS REQUIRED



Ladder



Safety glasses



Electrical tape



Phillips screwdriver



Flat blade screwdriver



Pliers

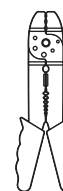

Wire strippers

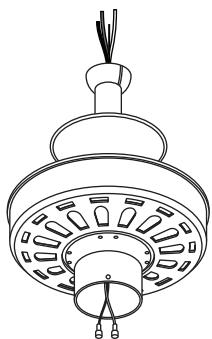

Fan Motor Assembly

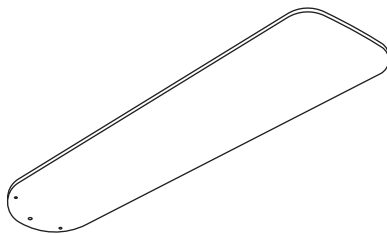

Blades

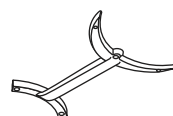

Blade Arms

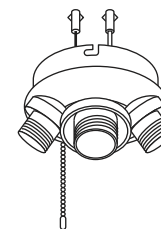

Light Kit



Socket Ring

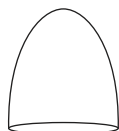

Shade

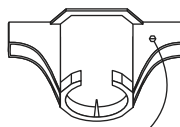

Mounting Unit

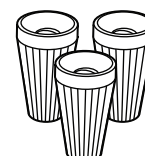

Wire Nuts

**\*PARTS SHOWN MAY DIFFER SLIGHTLY PER LIGHT FIXTURE**

# CEILING FAN

## Assembly Instructions

### STEP 1

Slide the **mounting unit** onto the screws of the junction box (not included).

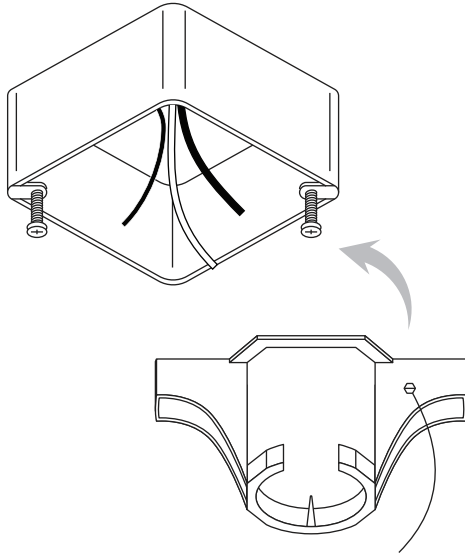

### STEP 2

Connect the blue and black wires of the fan to the black supply wire. Connect the white fan wire to the white supply wire. Connect the fan ground wire to the ground supply wire and the ground wire from the mounting unit. Use the supplied **wire nuts** and secure with electrical tape

Connect Clear, Brown, Gold or Black Parallel Wire without tracer (round & smooth) or Black Fixture Wire to:

Black or Red Supply Wire or Insulated Wire (other than green) with copper conductor.

Connect Clear, Brown, Gold or Black \*Parallel Wire with tracer (square & ridged) or White Fixture Wire to:

White Supply Wire or Insulated Wire (other than green) with silver conductor

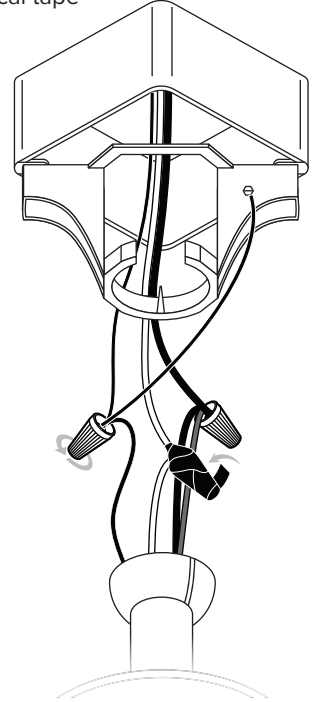
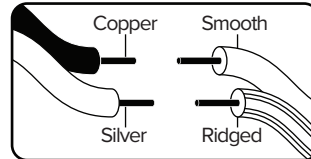

### STEP 3

Assemble the ceiling fan and attach the light kit. Install the bulbs (not included).

