

# TOTO

**TOTO U.S.A., Inc.**

1155 Southern Road Morrow, GA 30260

Phone : (770) 282 8686

## Warranty Registration and Inquiry

For product warranty registration, TOTO U.S.A. Inc. recommends On-Line Warranty Registration. Please visit our web site <http://www.totousa.com>. If you have questions regarding warranty policy or coverage, please contact TOTO U.S.A. Inc.,

Customer Service Department, 1155 Southern Road, Morrow, GA 30260 (888) 295 - 8134 or (678) 466 - 1300 when calling from outside of U.S.A.

- You are advised to record the following information to allow quick service.

Date of purchase :	Name of shop :
Date : year month day	Tel : (      )

# TOTO

Instruction Manual

## WASHLET



### washlet

B200 SW542  
(TCF6331U)

B150 SW532  
(TCF6301U)

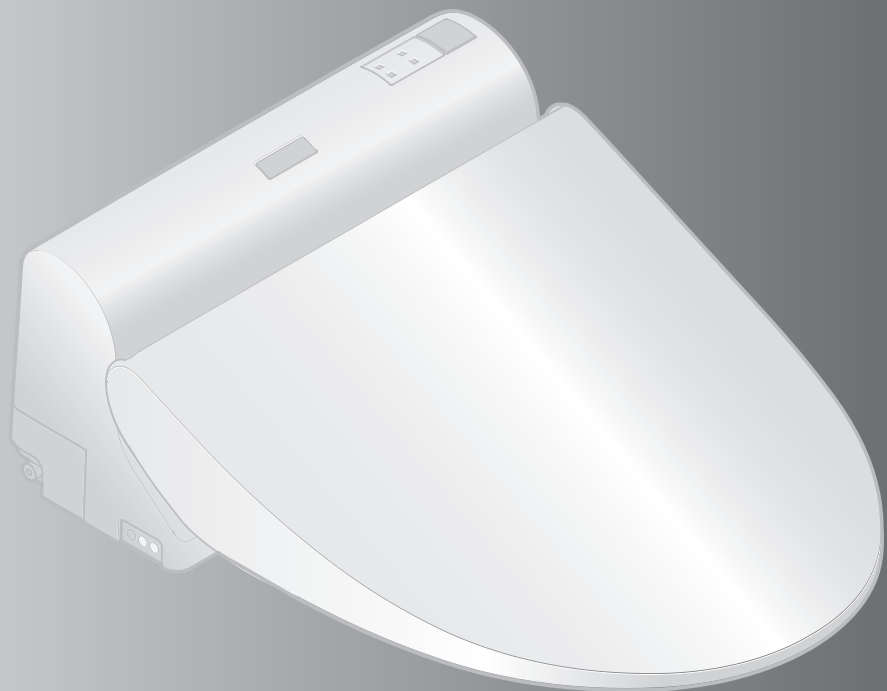

- Thank you for your recent purchase of the TOTO Washlet. Please read the enclosed information to ensure the safe use of your product.
- Be sure to read this Instruction Manual before using your product and keep it in a safe place for future reference.

The available functions vary according to the model.

Check your model name and write a check mark in this field as needed.

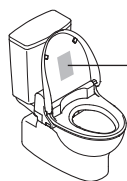

The model name and part number are indicated on the bottom side of the toilet lid.

Functions		Your Model	Model	B200	B150	Ref. Page
			Part No.	SW542	SW532	
Basic Functions	Cleansing	Rear cleansing		●	●	16
		Rear soft cleansing		●	●	
		Front cleansing		●	●	
	Changing the washing method	Wand position adjustment		●	●	16, 17
		Water pressure adjustment		●	●	
		Oscillating cleansing		●	●	
		Pulsating cleansing		●	●	
	Drying	Warm air drying		●	—	16
Changing the temperature		Temperature adjustment		●	●	22, 23
Sanitary Functions	Removing odors	Deodorizer		●	—	20, 21
Convenient Functions	Heating the toilet seat	Heated seat		●	●	—
	Saving energy	Auto energy saver		●	●	24, 25
		Timer energy saver		●	●	
Maintenance		Main Unit One-touch removal		●	●	30
		Removable toilet lid		●	●	31
		Wand cleaning		●	●	32

# Table of Contents

Safety Precautions .....	4
Operational Precautions.....	11
Parts Names .....	12
Preparation.....	14
Basic Operations .....	16
Automatic Functions (Cleaning Features).....	20
DEODORIZER	
Temperature Adjustment.....	22
Energy Saver Features.....	24
Power Plug .....	28
Main unit.....	29
Deodorizing Filter .....	29
Gap between the Main Unit and the Toilet Bowl .....	30
Gap between the Main Unit and the Toilet Lid .....	31
Wand .....	32
Wand cleaning	
Water Filter Drain Valve.....	33
Changing Settings .....	34
What to Do?.....	40
● If you cannot operate with the remote control .....	40
● Freeze Damage Prevention ...	41
● Long Periods of Disuse .....	42
Troubleshooting .....	43
Specifications .....	47
Warranty .....	48

Introduction

Operation

Maintenance



Reference





# Safety Precautions

These precautions are important for safe usage. Be sure to follow them and use the product correctly.

## Symbols and Meanings

	<b>WARNING</b>	May result in death or serious injury.
	<b>CAUTION</b>	May result in injury or property damage.

The following symbols are used to indicate important safety instructions for the use of the product.

Symbol	Meaning
	This symbol indicates a prohibited use of the product.
	This symbol is used to indicate a required step in the use of this product.

- This product is classified as Class 1 Equipment and must be grounded.
- Install this equipment where the electrical outlet is accessible.
- This appliance is not intended for use by persons (including children) with reduced physical, sensory or mental capabilities, or lack of experience and knowledge, unless they have been given supervision or instruction concerning use of the appliance by a person responsible for their safety.  
Children should be supervised to ensure that they do not play with the appliance.
- Use the new hose set included with this equipment. Do not reuse an old hose set.

## **WARNING**

	<b>Do not plug or unplug the power plug with wet hands.</b>
	• Doing so may cause electrical shock.
	<b>Do not get any water or cleaning solution on the main unit or power plug.</b>
	• Doing so may cause fire, electrical shock, heat or short circuit. • Doing so may cause the product to crack resulting in injury or water damage.
	<b>Never disassemble, repair or alter.</b>
	• Doing so may cause fire, electrical shock, heat or short circuit.
	<b>Do not install the product on moving vehicles such as wheeled vehicles or boats.</b>
	• Doing so may cause fire, electric shock, short circuit or malfunction. • The toilet seat, toilet lid, main unit or other parts may come loose and fall off, resulting in injury.

# WARNING

**Do not use the Washlet if a malfunction occurs.**

**Always unplug the plug from the outlet.**

- Close the water shutoff valve to stop water supply.

Possible malfunctions:

- Water is leaking from a pipe or the main unit
  - The product is cracked or broken.
  - The product makes a strange noise or emits a strange odor.
  - The product emits smoke.
  - The product is abnormally hot.
  - The toilet seat cushion is out of place.
- Continued use after malfunction could cause a fire, electric shock, heat, short circuit, injury or water damage.

**Only use tap water or potable well water (underground water).**

**Do not use seawater.**

- Doing so may cause irritation to the skin and malfunction.

**Do not touch the power plug during thunderstorms.**

- Doing so may cause electrical shock.

**Do not allow the water supply hose to touch the power plug or outlet.**

- Doing so may cause condensation resulting in a fire, electrical shock, heat or a short.

**Do not do anything that may damage the power cord, power plug.**

Do not strike, yank, twist, excessively bend, damage, alter, or heat the electrical cords. Also, do not place anything heavy on, bind or pinch the electrical cords.

- Using a damaged electrical cord may result in a fire, electrical shock, heat or short.

**Do not use a loose or faulty electrical outlet.**

- Doing so may cause fire or short circuit.

**Do no use any outlet or wiring equipment beyond its specified rating.**

- Plugging too many plugs into the same outlet, for example using outlet splitters, can cause fire due to heat.

**Do not use any power supply other than the one specified.**

**AC 120V,60Hz**

- Doing so may cause fire or excessive heat.

**Do not stick a finger or anything else into the warm air outlet.**

Do not place anything on the warm air outlet or drape clothes over it.

- Doing so may cause burns, electrical shock or malfunction.

**Keep cigarettes and other open flames away from the product.**

- Failure to do so may cause fire.



# Safety Precautions (Continued)

## WARNING

### **Beware of irritation or burn.**

- Improper use of the toilet seat may cause irritation or burn.

When sitting for a long time on the toilet seat, switch the toilet seat temperature adjustment to "OFF".  
When any of the following persons use a heated seat or warm air drying, someone should switch the toilet seat temperature adjustment to "OFF" and switch the drying air temperature to "Low".

- Young children, the aged and other users unable to set the temperature appropriately themselves
- The ill, physically disabled and others who do not have freedom of movement.
- Those using any medicines that cause drowsiness (sleeping or cold medicine), those who have been drinking heavily, anyone severely fatigued and anyone else liable to fall asleep.

**This is an electrical product. Do not install it anywhere water is likely to get on the product or anywhere with humidity high enough that water is likely to form on the surface of this product. When using the product in a bathroom, install a fan or ventilation port and ensure good air flow through the bathroom.**

- Failure to do so may cause fire or electrical shock.

### **Always connect the Washlet to the cold water supply.**

- Connecting to hot water supply may result in burns and equipment damage.

### **Make sure that a properly grounded (3 prong) outlet has been installed.**

- Failure to install a grounded outlet could cause electrical shock in the event of a malfunction or short circuit.



### **Insert the power plug securely into the outlet.**

- Failure to do so may cause fire, heat or short circuit.

### **To unplug, hold the plug, not the cord.**

Do not unplug by pulling the cord.

- Pulling on the cord may cause damage and result in fire or heat.

**If the electric cord is damaged, avoid danger by having the manufacturer's repair department or equivalent specialist replace it.**

### **Always disconnect the power plug from the outlet before cleaning, maintenance or inspection.**

- Failure to do so may cause electrical shock or malfunction.  
\* Except when using "Wand cleaning".

### **Periodically remove dust and dirt from the electrical plug and make sure it is securely plugged into the wall outlet.**

- Failure to do so may cause fire, heat or short circuit.  
Pull the plug out from the outlet and wipe clean with a dry cloth.

### **Always unplug the plug from the outlet before removing the main unit.**

- Failure to do so could cause a fire or electrical shock.

## WARNING



**Preliminary studies in females suggest that overuse of continuous spraying can increase the possibility of vaginal mucosa drying and potential reduction in desirable microbial organisms.**

**Although these studies have not been validated, please consult your healthcare provider for concerns regarding whether these circumstances may apply to you.**

**More importantly, if you are an individual suffering from any immune deficiency as a result of disease, chemotherapy, or other medical condition compromising the immune system you should consult your healthcare provider before use of this product.**

## CAUTION



**Do not use the product if the main unit is unstable.**

- Doing so may cause the main unit to come loose and fall, resulting in injury.

**If the product is damaged, do not touch the damaged section.**

- Doing so may cause electrical shock or injury.  
Replace it immediately.

**Do not apply strong force, mechanical shock, step on or stand on the toilet seat, toilet lid or main unit. Also do not place any heavy object on the toilet seat, toilet lid or main unit.**

- Doing so may cause cracking or cause the main unit to come loose and fall, resulting in injury.
- Doing so could damage the product and cause injury or water damage.

**Do not lift up this product by the toilet seat or lid.**

**Do not raise the toilet seat or lid while objects are resting on top of the toilet.**

- Doing so may cause the main unit to come loose and fall, resulting in injury.

**When cleaning or maintaining the plastic parts (main unit etc.) or the water supply hose, use a kitchen cleaner diluted with water. Do not use any of the following.**

Toilet cleaner, household cleaner, benzene, paint thinner, powdered cleanser or nylon scrubbing pads.

- These items may damage or crack the plastic and cause injury or malfunction.
- These items could damage the water supply hose and cause a water leak.



# Safety Precautions (Continued)

## CAUTION



**To prevent a sudden water leak, do not remove the water filter drain valve when the shutoff valve is open.**

- Doing so will cause water to spurt out.  
(Refer to Page 33 for instructions on cleaning the water filter drain valve.)

**Do not fold or crush the water supply hose; do not damage by cutting with a sharp object.**

- Doing so may cause water leaks.

**Do not install the base plate, which is not attached.**

- Doing so could cause a fire or damage.



**If a water leak should occur, always close the shutoff valve.**

**When the ambient temperature is likely to drop to 0°C (32°F) or lower, prevent damage to the pipes and hoses due to freezing.**

- Frozen water pipes could cause the main unit and the pipes to break, resulting in a water leak.
- Regulate the room temperature to prevent the pipes and hoses from freezing during cold months.
- Drain the water.

**When not using the Washlet over an extended period of time, drain the water out of the main unit and the water supply hose after closing the water shutoff valve, and pull the electrical plug from the outlet.**

When using the product again, allow the product to refill with water first.

- Otherwise, the water in the tank might become contaminated and cause skin inflammation or other problems. (Refer to Page 41 for instructions on replenishing the water.)
- Leaving the power on may cause fire or heat.

**When installing the water filter drain valve, make sure that it is securely tightened in its proper position.**

- Failure to securely tighten it may cause a water leaks.

**Push the main unit securely on to the base plate.**

After pushing the main unit until a click sound is heard, pull it slightly toward you to make sure that the product does not detach.

- Failure to do so could cause the main unit to come loose and fall resulting in injury.

**DANGER** To reduce the risk of electrocution:

1. Do not use while bathing.
2. Do not place or store the product where it can fall or be pulled into a tub or sink.
3. Do not place in or drop into water or other liquid.
4. Do not reach for the product when it has fallen into water. Unplug it immediately.

**WARNING** To reduce the risk of burns, electrocution, fire or injury to persons:

1. Close supervision is necessary when this product is used by, on, or near children or invalids.
2. Use this product only for its intended use as described in this manual. Do not use attachments not recommended by the manufacturer.
3. Never operate this product if it has a damaged cord or plug, is not working properly, has been dropped or damaged, or has been dropped in water. Return the product to a service center for examination and repair.
4. Keep the cord away from heated surfaces.
5. Never block the air openings on the product or place it on a soft surface, such as a bed or couch, where the air openings may be blocked. Keep the air openings free of lint, hair, and other similar items.
6. Never use while sleepy or drowsy.
7. Never drop or insert any object into any opening or hose.
8. Do not use outdoors. Do not operate where aerosol (spray) products are being used or where oxygen is being administered.
9. Connect this product to a properly grounded outlet only.  
See "Grounding Instructions" in Page 10.
10. The tank should be filled with water only.

# Safety Precautions (Continued)

## Grounding Instructions

This product should be grounded. In the event of an electrical short circuit, grounding reduces the risk of electric shock by providing an escape wire for the electrical current.

The plug must be plugged into an outlet that is properly installed and grounded.

 **DANGER** - Improper use of the grounding plug can result in a risk of electric shock.

If repair or replacement of the cord or plug is necessary, do not connect the grounding wire to either flat-head terminal.

Check with a qualified electrician or serviceman if the grounding wire instructions are not completely understood, or if in doubt as to whether the product is properly grounded.

This product is factory equipped with a specific electric cord and plug to permit connection to a proper electric circuit. Make sure that the product is connected to an outlet having the same configuration as the plug.

No adapter should be used with this product. Do not modify the plug provided - if it will not fit in the outlet, have the proper outlet installed by a qualified electrician.

If the product must be reconnected for use on a different type of electric circuit, the reconnection should be made by qualified service personnel.

If it is necessary to use an extension cord, use only a three wire extension cord that has a three blade grounding plug, and a three-slot receptacle outlet that will accept the plug on the product.

Replace or repair a damaged cord.

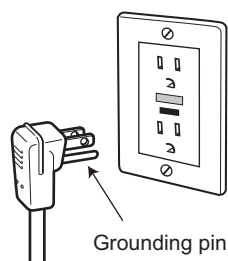

**Save these instructions.**

# Operational Precautions

## ■ For prevention of malfunctions

- Do not block the remote control transmitter or receiver.

### < About the seat switch >

- When you sit on the toilet seat, the seat switch turns ON, enabling you to use various features.  
(A click sound is heard when the seat switch is ACTIVATED.)

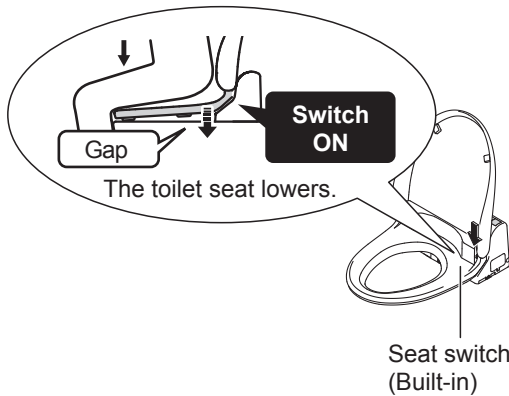

- Sit back on the toilet seat.
  - The seat switch will not turn on unless you sit on the seat properly.



### Note

- When a child uses the Washlet, the seat switch may not be ACTIVATED by their light body weight.
- Since the toilet seat is designed to move up and down, a clearance is provided between the toilet seat cushion and the toilet bowl.

## ■ For prevention of damage

- Wipe plastic areas such as the main unit and remote control with a soft, wet cloth.
- Do not lean against the toilet lid.



## ■ Problem Prevention

- Disconnect the power plug if there is a risk of lightning.
- A toilet seat cover or a toilet lid cover cannot be used.  
(The seat switch may not function properly.)



- Do not urinate on the main unit, toilet seat or wand.  
(Doing so may cause pink or brown stains or a malfunction.)
- Do not apply strong forces to the control panel of the remote control.
- When using a toilet cleaner to clean the toilet, wash it off within 3 minutes and leave the toilet seat and toilet lid open. Wipe off any cleaner that remains on the toilet bowl.  
(If vapor from a toilet bowl cleaner enters the main unit, it may cause a malfunction.)
- Do not expose to direct sunlight.  
(Doing so may cause changes in color, irregular heated seat temperature, remote control malfunction or Washlet malfunction due to the change in temperature.)
- Use radios, etc. away from the Washlet.  
(The Washlet could cause interference with the radio signal.)
- If you use a booster seat for infants or a soft highchair, remove it after use.  
(Keeping it installed may prevent some of the functions from being used.)
- Do not apply force to the remote control.  
(May cause malfunction.)  
To prevent the remote control from being dropped, set it in the hanger when you are not using it. Be careful not to expose it to water.

# Parts Names

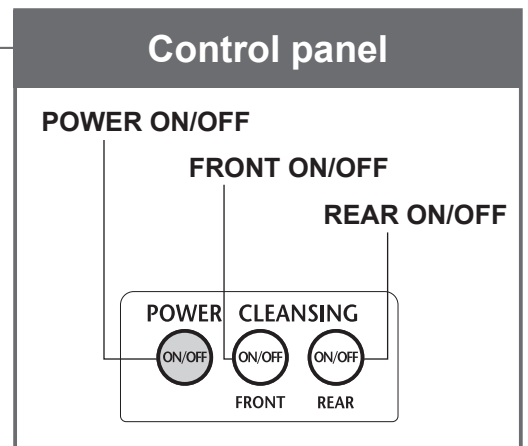
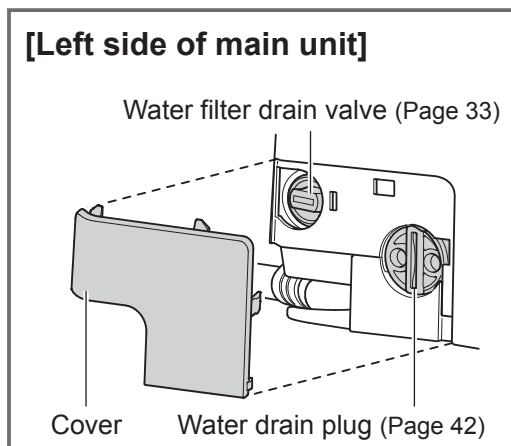
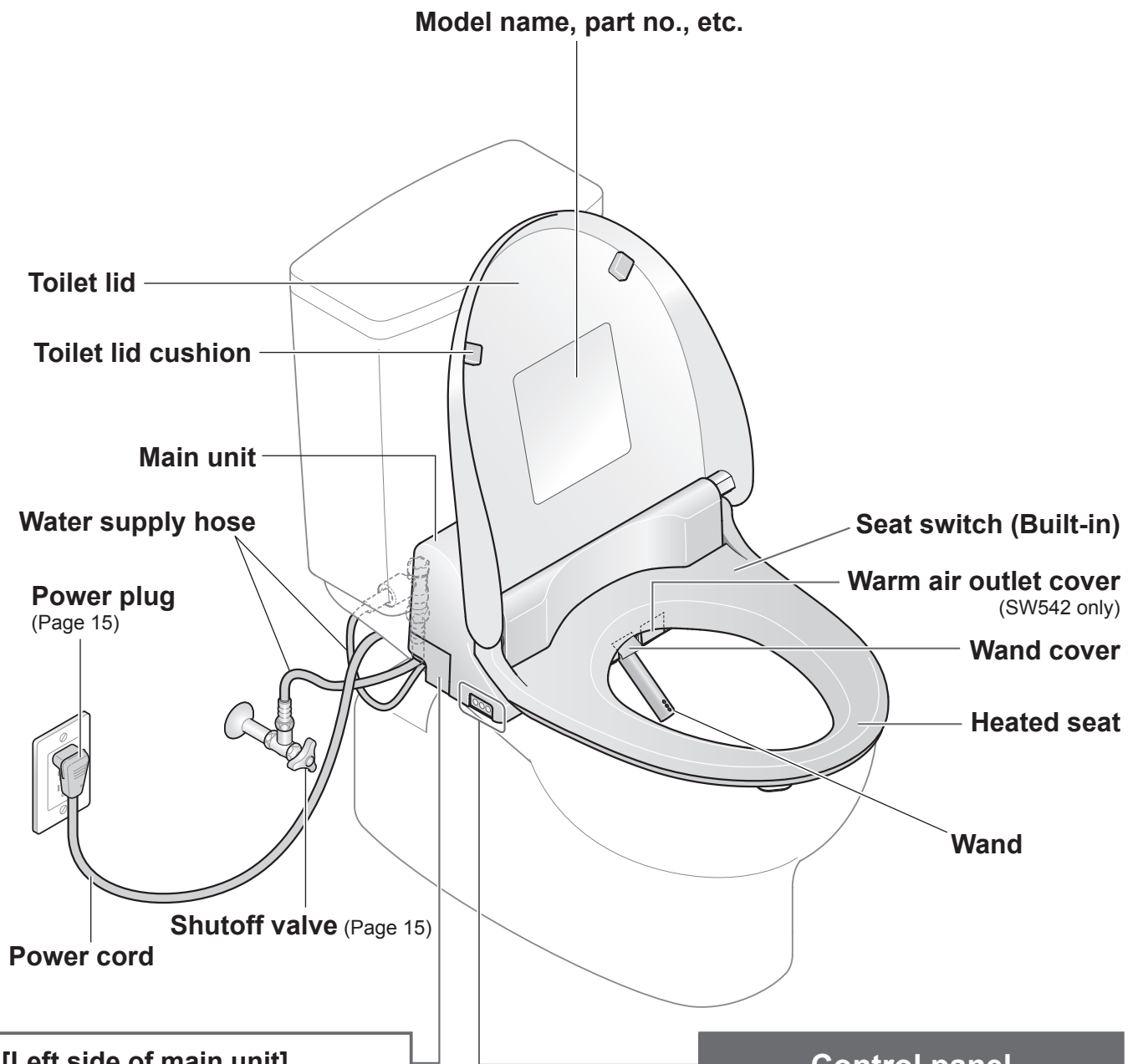

[Right side of main unit]

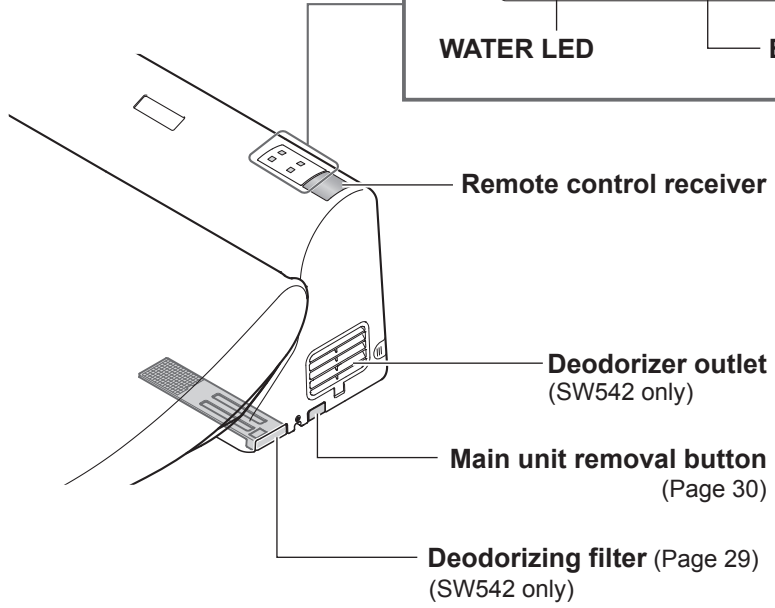
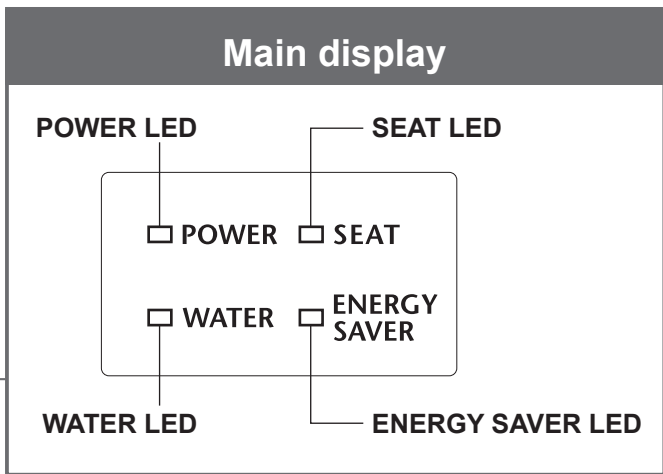

Toilet seat cushions

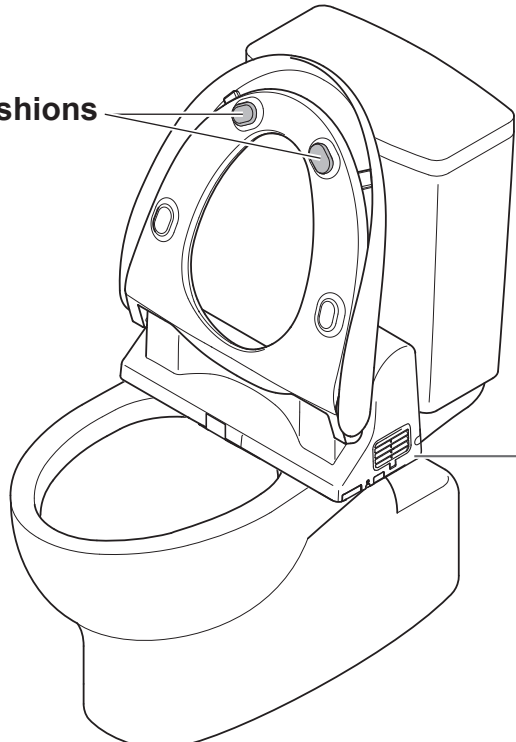

# Preparation

## Using the Product for the First Time

### 1. Insert the battery

- 1 Remove the remote control from the hanger.

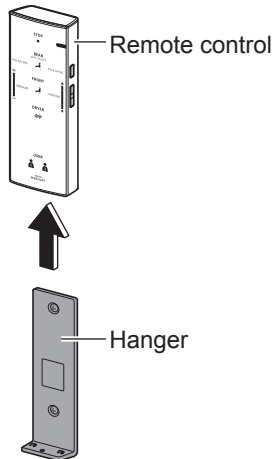

- 2 Open the battery cover and insert two AA batteries.

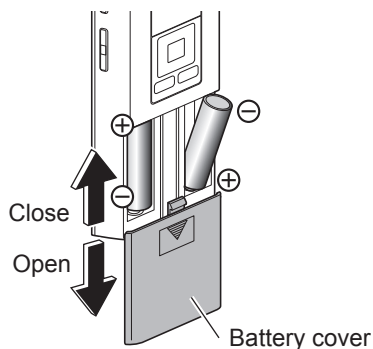

- When batteries are properly inserted, temperature levels appear on the display of the remote control (back side).
- The display goes out when no button on the remote control is pressed for 5 minute or more.

- 3 Mount the remote control in the hanger.

#### ■ About the batteries

- Use dry cell, alkaline batteries. Follow the instructions below to prevent the batteries from rupturing or leaking fluid.
- When replacing the batteries, use new batteries of the same brand.
- If you will not be using the remote control for a long time, remove the batteries.
- Do not use rechargeable batteries.

### If the remote control is secured (for anti theft)

- 1 Remove the screw from the remote control fixture.

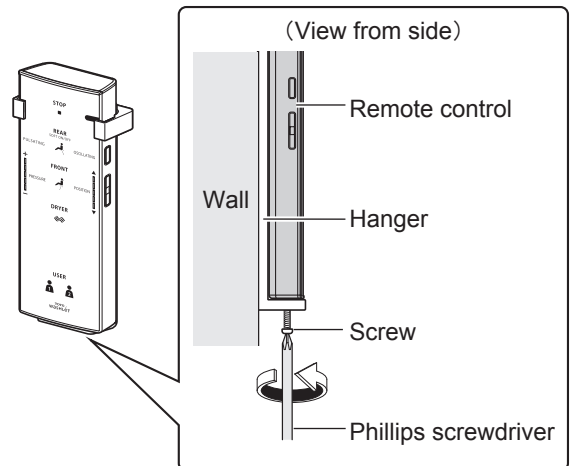

- 2 Remove the remote control from the hanger.

- To secure the remote control again  
Tighten the screw.  
(Overtightening may cause damage to parts such as the hanger)

## 2. Turn on the power

- 1** Insert the power plug.  
 • The wand extends and then retracts.

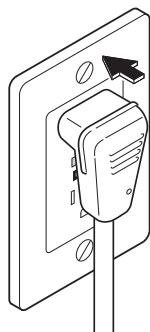

- 2** Check that the POWER LED on the main display is lit up.  
 • If it does not light up, press [POWER ON/OFF] to light it up.

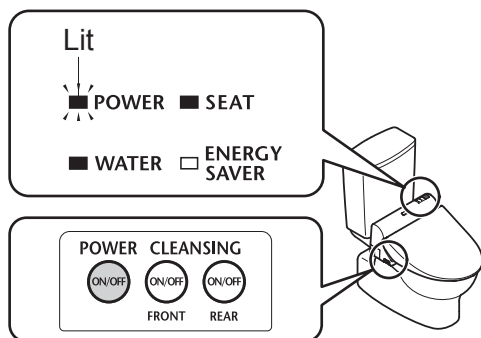

## 3. Open the shutoff valve

- 1** Fully open the shutoff valve.

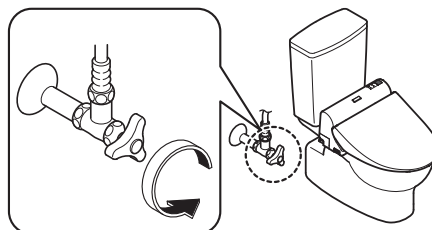

## To turn the power "OFF"

**POWER**  
 Press [POWER ON/OFF] to turn the power off.

- The POWER LED goes off.



# Basic Operations

Press a button on the remote control; a beep sounds when the main unit receives the signal.

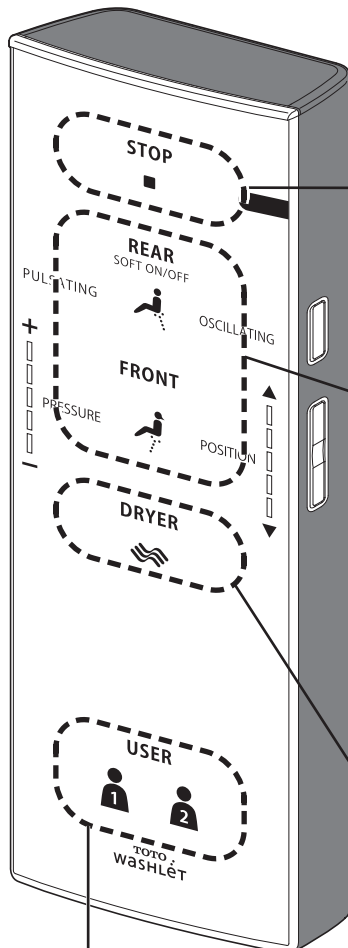

(The drawing is SW542)

## Stopping

 **[STOP]**  
Stops the operation.

## Cleansing

 \* **[REAR]**  
Cleanses your rear.

-----  
 **[SOFT]**  
Washes your rear with mild water pressure.

\*The mode changes between [SOFT] (Flickering) and [REAR] (Lit) each time the button is pressed.

-----  
 **[FRONT]**  
Serves as a bidet for ladies.

## Drying (SW542 only)

 **[DRYER]**  
Dries your rear.

## Personal Setting Lock



**[USER1] / [USER2]**

You can store your preferred wand position, water pressure and water temperature a setting.

- To store a setting

While cleansing is in progress, set your preferred wand position, water pressure, and warm water temperature, and then press and hold [USER 1] or [USER 2] for 2 seconds or longer.

- To use

Press [USER 1] or [USER 2], and then press the button for the cleansing you want to use.

\*The wand position and water pressure lamps will light up for about 10 seconds in their set positions, and the water temperature display switches.

- Functions that operate when a button is pressed during "REAR", "SOFT", or "FRONT" cleansing.

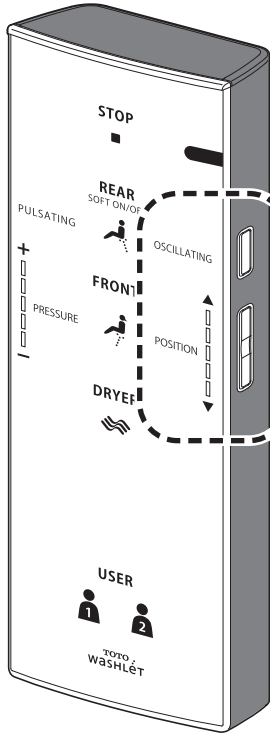

**[OSCILLATING]**

- The wand moves back and forth to wash your rear thoroughly.
- The setting changes between "ON" and "OFF" each time the button is pressed.

---

**[POSITION]**

- The wand position can be adjusted to the front or rear.
- ( "▲": Moves to the front, "▼": Moves to the rear )

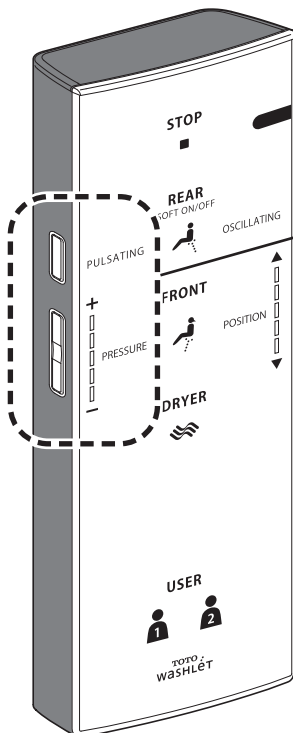

**[PULSATING]**

- Washes with the water pressure pulsating between soft and strong.
- The setting changes between "ON" and "OFF" each time the button is pressed.

---

**[PRESSURE]**

- The water pressure strength can be adjusted for cleansing functions such as REAR. ("-" : Softer, "+" : Stronger)

**Note**

- Sitting back on the toilet seat makes it easier to adjust the wand position and to reduce splashing.

**For your information**

- Water may sometimes come out from around the wand when it expands in the warm water tank, but this is normal.
- As the warm water tank of hot-water system is used, the temperature of warm water may become lower if it is continuously consumed.

# Basic Operations

## About the Menu Screen

This section is an overview of the settings that can be configured with the remote control.

- See the corresponding pages for the detailed descriptions.
- The setting items and numbers vary according to the model.

### Remote control back side

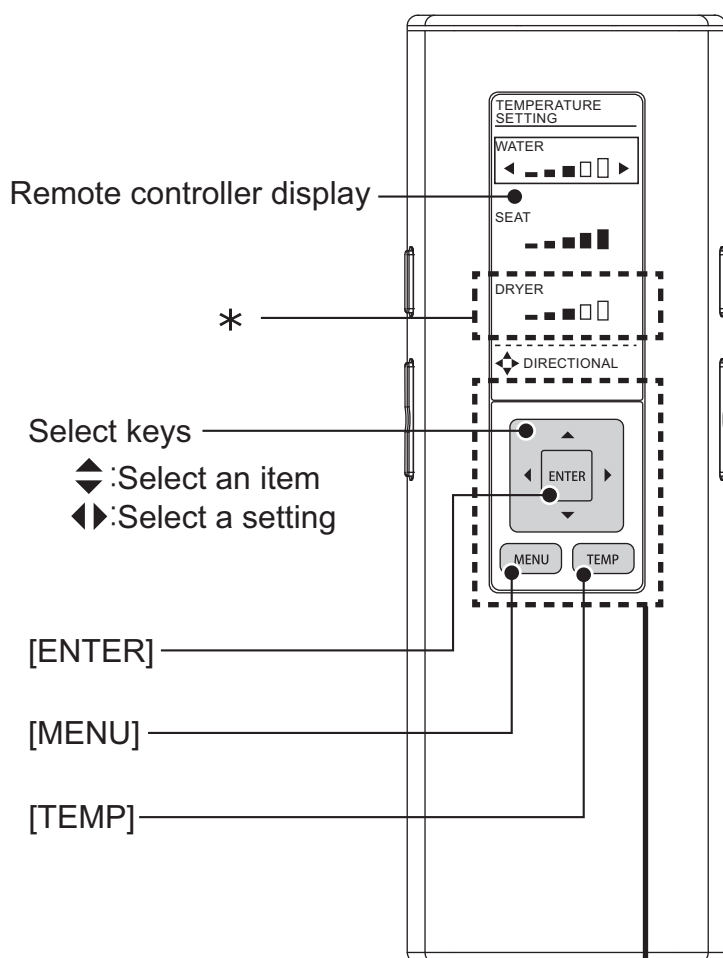

- ◆: Select an item
- ◀▶: Select a setting

Press [MENU] to display the menu screen.



### SETTING LOCK

You can lock the settings so that you do not mistakenly operate the rear buttons while using the remote control.

How to Set (Page 38)

Display screen during setting lock



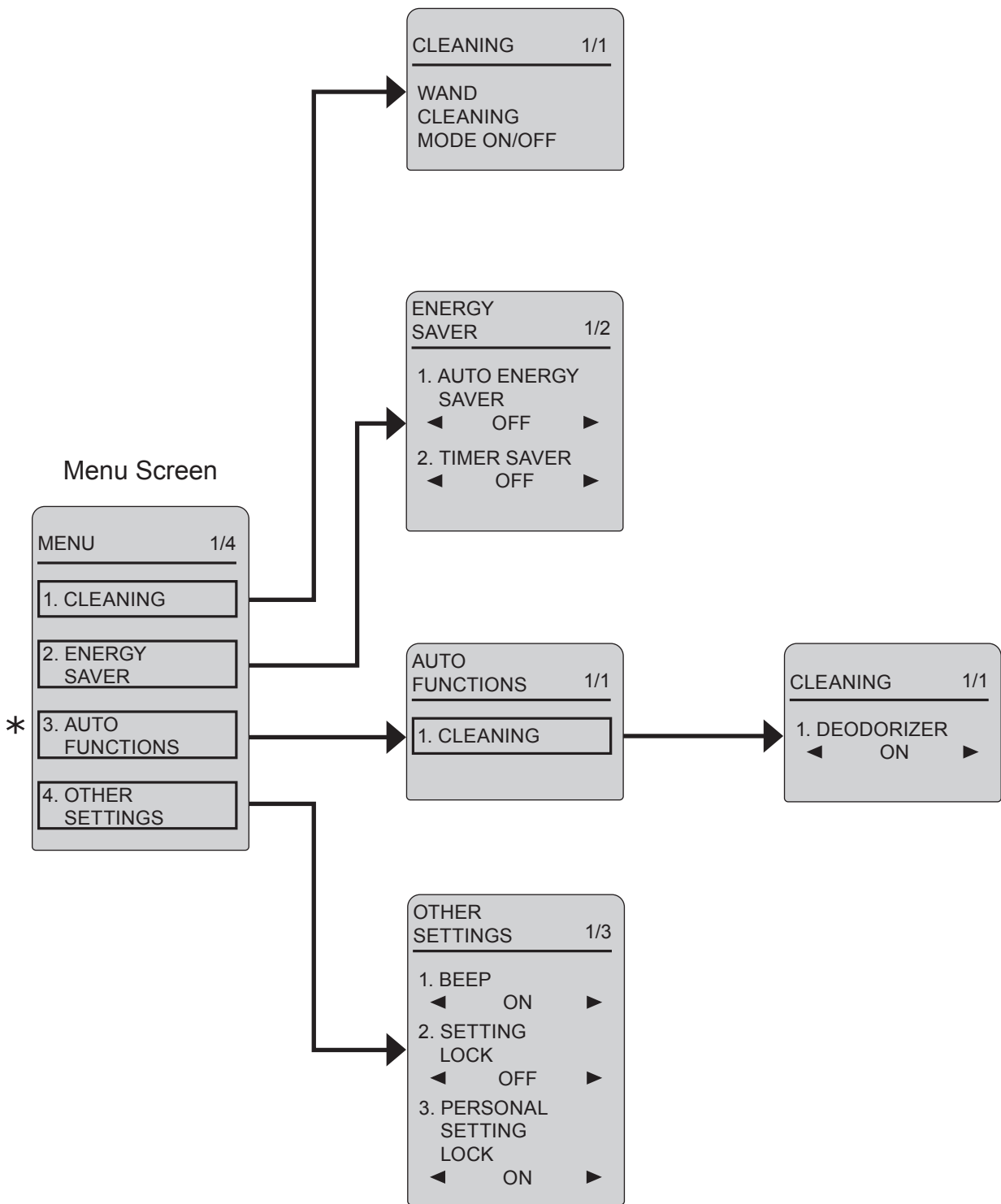

\* Will not be displayed on SW532 remote control.

# Automatic Functions

## Cleaning Features

As you approach



As you sit



**DEODORIZER**  
(SW542 only)



Starts the deodorizer

\* Water comes out from around the wand.

## As you stand up\*



### ■ Changing settings

#### If dirt adheres...

■ If dirt adheres to the wand during use, you can extend the wand to clean it.

- Cleaning the wand (Page 32)

#### Deodorizer stops

→It stops after about 2 minutes

- DEODORIZER ON/OFF (Page 36)

# Temperature Adjustment

## Warm Water / Toilet Seat / Drying

You can adjust the temperature levels or turn the settings to "OFF".

**1**  Press [TEMP].

**2**  Use  to select the item you want to set.

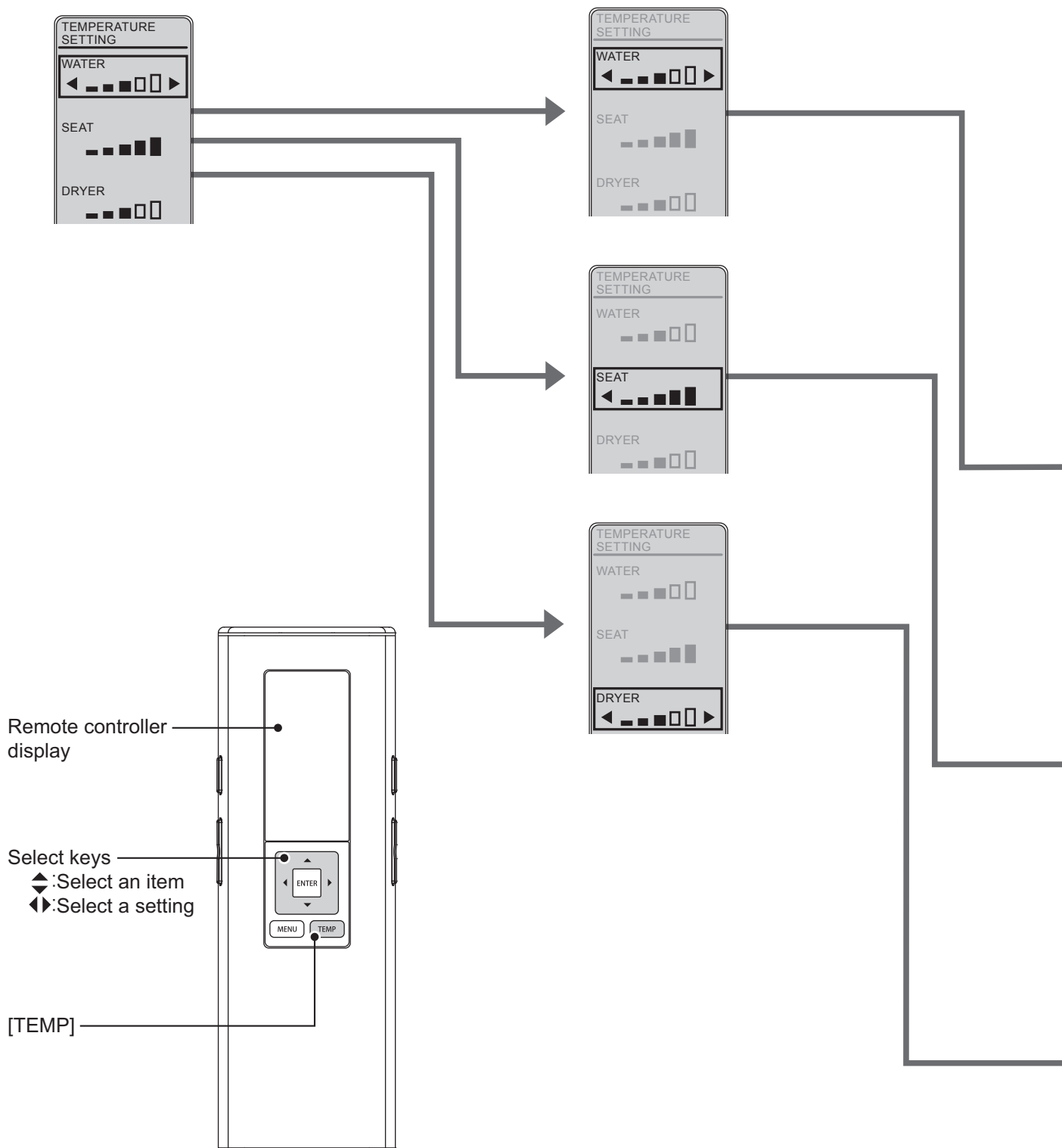

3



Use ◀▶ to select the temperature level. <Settings complete>

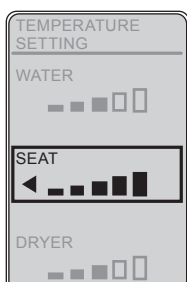

### Warm water temperature

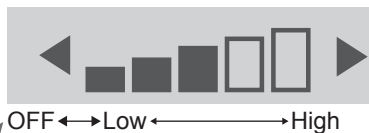

Press ◀ until "OFF" appears.

- When "OFF" is set, the WATER LED will go off.

### Toilet seat temperature

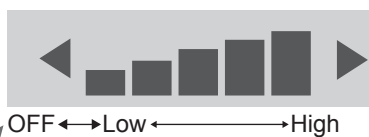

Press ◀ until "OFF" appears.

- When "OFF" is set, the SEAT LED will go off.

### Drying air temperature\*

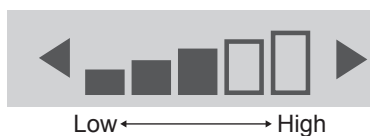

\* Will not be displayed on SW532 remote control.



# Energy Saver Features Type



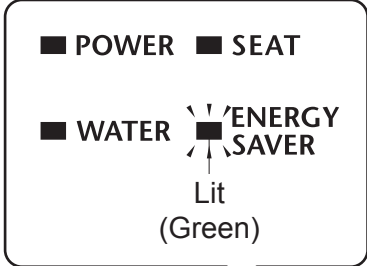
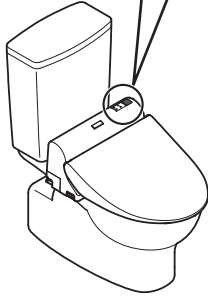
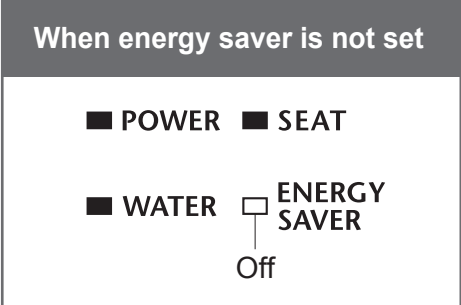

You can save energy by turning the toilet seat heater to a low temperature (or turning the heater "OFF") during periods when the toilet will be used infrequently.

- It takes about 10 days for the product to determine the periods when it is used relatively less frequently.

Type	Situation	When energy saver is set	Main Display
<b>AUTO ENERGY SAVER</b>	<p><b>You want to save energy but dislike a cold toilet seat</b></p> <p>The Washlet detects time periods with infrequent use and lowers the toilet seat temperature automatically.</p>		→
<b>TIMER ENERGY SAVER</b>	<p><b>You want to save energy only for the preset duration of time.</b></p> <p>If you set the duration of time (3 hours, 6 hours or 9 hours) during which you want to save energy, the heater automatically turns off every day in the set time slot.</p>		→
<b>AUTO ENERGY SAVER + TIMER ENERGY SAVER</b>	<p><b>You want to save a lot of energy with auto energy saver and timer energy saver</b></p> <p>When both timer energy saver and auto energy saver are set, auto energy saver operates when timer energy saver is not operating.</p>	<p>When energy saver is not set</p> 	→

**Note**

- Even if the toilet seat heater is set to "Low" or "OFF", the toilet seat is temporarily heated when you sit on it.

When energy saver is in operation		AM		PM			
Toilet seat heater		0	6	8	5	9	0
<input type="checkbox"/> POWER <input type="checkbox"/> SEAT <input type="checkbox"/> WATER <input checked="" type="checkbox"/> ENERGY SAVER Lit (Orange)	 Low	Example: Used infrequently from 9 pm to 6 am					
		Low temperature <sup>*2</sup>	Set temperature <sup>*1</sup>				Low temperature <sup>*2</sup>
<input type="checkbox"/> POWER <input type="checkbox"/> SEAT <input type="checkbox"/> WATER <input checked="" type="checkbox"/> ENERGY SAVER Lit (Green)	 OFF <sup>*4</sup>	Example: Set from 8 am to 5 pm					
		Set temperature <sup>*1</sup>			Set temperature <sup>*1</sup>		
				OFF <sup>*3</sup>			
<ul style="list-style-type: none"> <li>• During timer energy saver : Same LED indication as timer energy saver (See above)</li> <li>• During auto energy saver : Same LED indication as auto energy saver (See above)</li> </ul>	 Low  OFF <sup>*4</sup>	Example: When timer energy saver and auto energy saver are used together					
		Low temperature <sup>*2</sup>	Set temperature <sup>*1</sup>		Set temperature <sup>*1</sup>		Low temperature <sup>*2</sup>
				OFF <sup>*3</sup>			

\*1 The toilet seat temperature set on Page 22.

\*2 The time period when the toilet seat heater is set to a low temperature by the auto energy saver.

\*3 The time period when the toilet seat heater is "OFF".



\*4 The warm water heater also turns off.

# Energy Saver Features

## How to set

Set the timer energy saver at the time you want to start it.

1  Press [MENU].

2  Use  to select "ENERGY SAVER" and then press [ENTER].

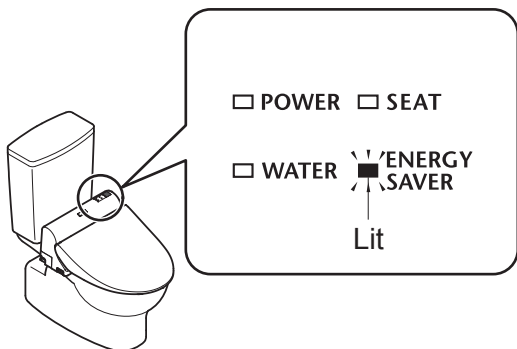
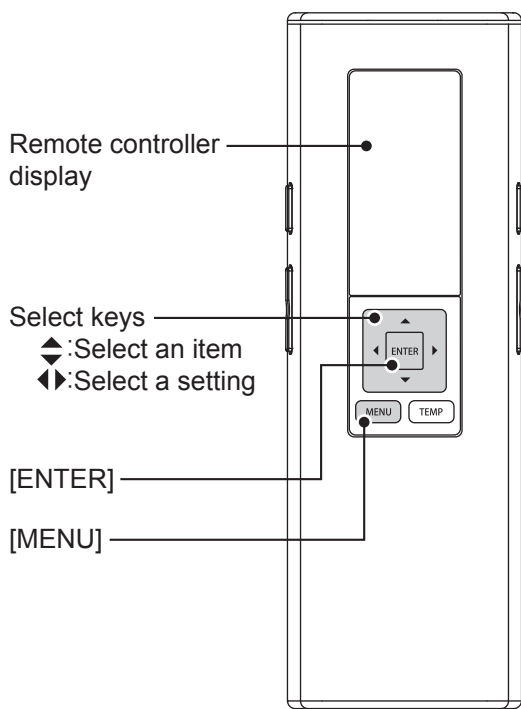
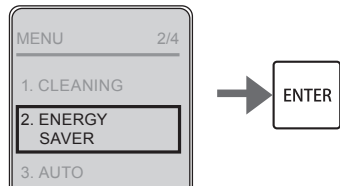

The ENERGY SAVER LED will be lit if the energy-saver feature is working.

AUTO ENERGY SAVER : Lit (Orange)

TIMER ENERGY SAVER : Lit (Green)



**3** Use  to select "AUTO ENERGY SAVER".

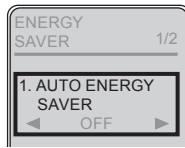

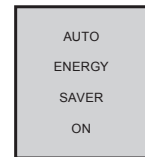
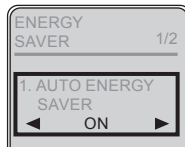

**4** Use  to select "ON" or "OFF" and then press [ENTER].

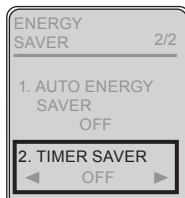

(To return → )

**3** Use  to select "TIMER SAVER".



**4** Use  to select "3H", "6H", "9H" or "OFF" and then press [ENTER].

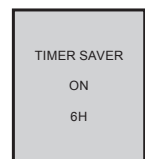
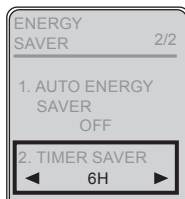

(To return → )

■ To change the timer energy saver time → Set the timer energy saver again at the time you want to start it.

Select "OFF" in step 4 in each procedure above and then press [ENTER].

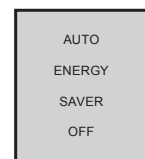
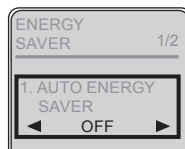

(To return → )

# Maintenance

## Power plug (Perform monthly)

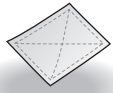

Dry cloth



Wet cloth

- 1 Disconnect the power plug and wipe it with a dry cloth.



- 2 Insert the power plug.

### WARNING



- Periodically remove dust from the blades and other parts of the power plug.
  - Disconnect the plug and wipe it with a dry cloth.

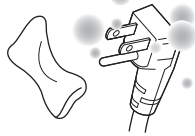

- Fully insert the power plug.
- When disconnecting, hold the main body of the power plug.
  - Pulling the cord may damage the plug or cord.

### WARNING



Always disconnect the power plug from the outlet before cleaning, maintenance or inspection. (see left)  
(Otherwise, it may cause electrical shock or malfunction.)

**\*For safety, disconnect the power plug before cleaning or maintenance.**

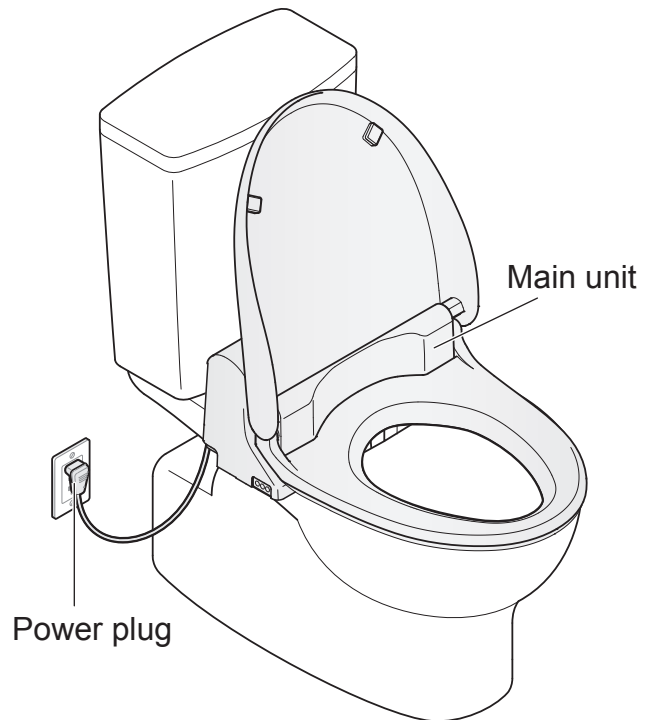

Do not use a dry cloth or toilet paper on plastic parts.  
(May cause damage.)

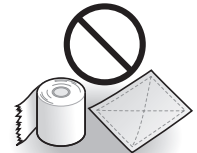

\*Except when using "Wand cleaning".

## Main Unit (Perform daily)



Soft cloth soaked in water

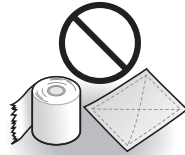

- Toilet paper
- Dry cloth
- Nylon scrubbing pads  
(May cause damage.)

**1** Unplug the power plug. (Page 15)

**2** Wipe with a soft cloth that has been soaked in water and wrung-out thoroughly.

### ■ For heavy dirt

- Wipe with a soft cloth soaked in diluted, neutral kitchen detergent, and then wipe with a soft cloth soaked in water.

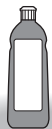

- Neutral kitchen detergent



- Paint thinner
- Benzene
- Powdered cleanser

**3** Insert the power plug. (Page 15)

### Attention!

- **The Washlet is an electric appliance. Be careful not to let water seep inside or leave detergent in the gap between the main unit and toilet bowl.**  
(May damage plastic parts or cause a malfunction.)
- **When using a toilet cleaner to clean the toilet, wash it off within 3 minutes and leave the toilet seat and toilet lid open.**
  - Wipe off any cleaner that remains on the toilet bowl. (If vapor from a toilet bowl cleaner enters the main unit, it may cause a malfunction.)
- **Do not push or pull the wand cover or the warm air dryer cover (SW542 only) with undue force.**  
(May cause damage or malfunction.)

## Deodorizing filter (Perform monthly) <If you notice odors> (SW542 only)

**1** Unplug the power plug.  
(Page 15)

**2** Remove the deodorizing filter.
 

- Hold the knob and pull outward.
- Do not pull with undue force.  
(May cause damage or malfunctions)

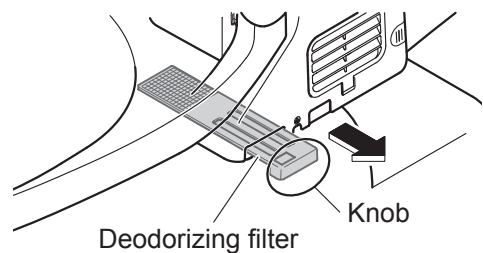

**3** Clean with a tool such as a toothbrush.

- When washing with water, dry off all water before mounting.

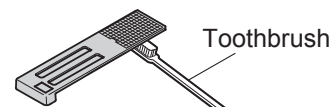

**4** Mount the deodorizing filter.

- Push firmly until a click sound is heard.

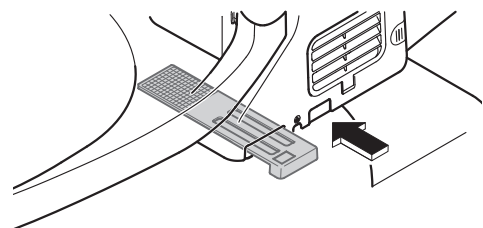

**5** Insert the power plug. (Page 15)

# Maintenance

## Gap between the Main Unit and Toilet Bowl (Perform monthly)

You can remove the main unit to clean the top of the toilet bowl and the bottom of the main unit.



Soft cloth soaked in water

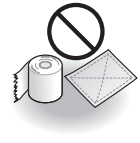

Toilet paper, etc.  
(May cause damage.)

- 1 Unplug the power plug.  
(Page 15)



If the power is not unplugged, the unit may malfunction or cause a failure or electric shock.

- 2 Remove the main unit.  
• Do not pull the unit with undue force (because the water supply hose and power cord are attached).

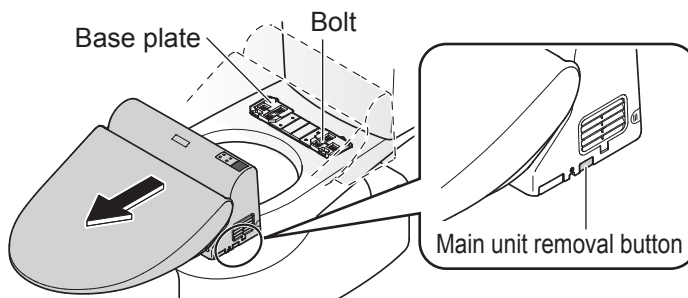

Pull the main unit toward you while pressing the button.

- 3 Clean the gap.  
• Wipe with a soft cloth soaked in a diluted, neutral kitchen detergent. Then, wipe it with a soft cloth soaked in water so that no detergent remains.

- 4 Mount the main unit.

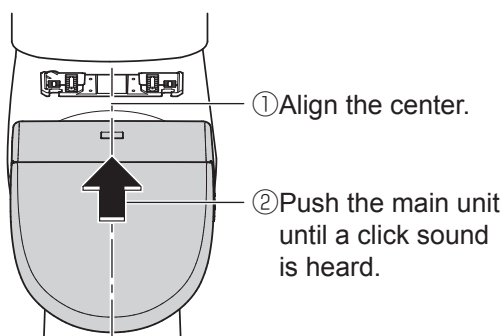

**⚠ CAUTION**

**!** Push the main unit firmly onto the base plate until a click sound is heard.

After mounting, check that the main unit does not detach even when pulled.

- 5 Insert the power plug. (Page 15)

- 6 Check the POWER LED on the control panel.

POWER LED	Status
Lit	Mounting is OK
Off	Press [POWER ON/OFF] and check that it lights up

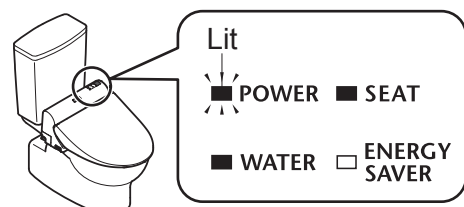

## Gap between the Main Unit and the Toilet Lid (Perform monthly)

The toilet lid can be removed for thorough cleaning.



Soft cloth soaked in water

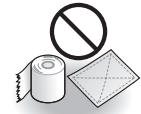

Toilet paper, etc.  
(May cause damage.)

**1** Unplug the power plug. (Page 15)



**2** Remove the toilet Lid.

Ⓐ: Pull the left side outward.



Ⓑ: Disconnect the hinge from the recess and pull up.



Ⓒ: Disconnect the right side.

**3** Wipe with a soft cloth that has been soaked in water and wrung-out thoroughly.

**4** Reinstall the toilet lid.

Ⓓ: Join the pin and the hinge on the right side.



Slightly tilt the toilet lid to the front.

Ⓐ: While pulling out the left side,



Ⓔ: Mount by joining the hinge with the recess.  
\* Be careful not to pinch your fingers.

**5** Insert the power plug. (Page 15)

**6** Open and close the toilet lid to check the mounting, and then mount the main unit.

### Removing and Reinstalling

Hold with both hands

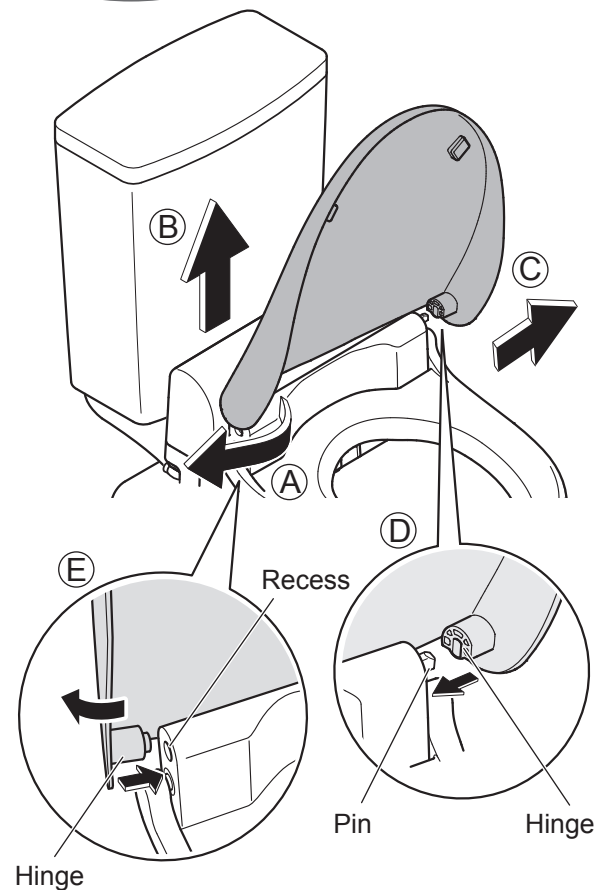



# Maintenance

## Wand (Perform monthly)

<Wand cleaning> If you notice dirt



Soft cloth soaked in water

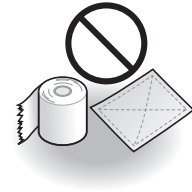

Toilet paper, etc.  
(May cause damage.)

1

### Extend the wand.

- Operate with the buttons on the back side of the remote control.

(1) Press [MENU].

(2) Use  to select "CLEANING".

Press [ENTER].

(3) Use  to select "WAND CLEANING MODE ON/OFF".

Press [ENTER].

- The wand extends and water sprays out for cleaning.
- The wand automatically retracts after about 5 minutes.

2

### Wipe with a soft, wet cloth.

- Do not pull, push or press the wand with excessive force. (May cause damage or malfunction.)

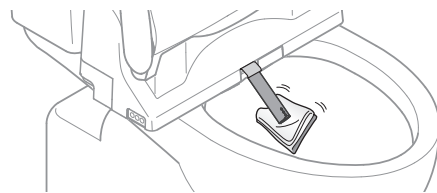

3

### Press [STOP] on the front side of the remote control.

- The wand retracts.

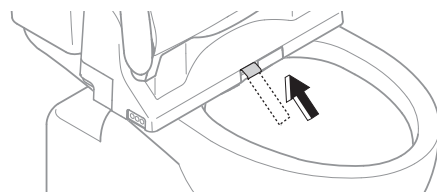

# Water filter drain valve (Perform once every 6 months)

<If you think the water pressure has weakened>



- 1** Close the shutoff valve. (Page 43)
- The water supply stops.

## CAUTION



**Do not remove the water filter drain valve while the shutoff valve is open.**  
(Otherwise, water may leak out)

- 2** Extend the wand.
- Operate with the buttons on the back side of the remote control.

- (1) Press [MENU].
- (2) Use  to select "CLEANING".  
Press [ENTER].
- (3) Use  to select "WAND CLEANING MODE ON/OFF".

Press [ENTER] to extend the wand.

Press [ENTER] again to retract the wand.

(Release the pressure from the water supply pipe.)

- 3** Unplug the power plug. (Page 15)

- 4** Remove the cover and water filter drain valve.

- Loosen with a flat-head screwdriver and then pull.

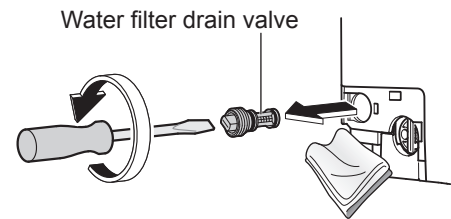
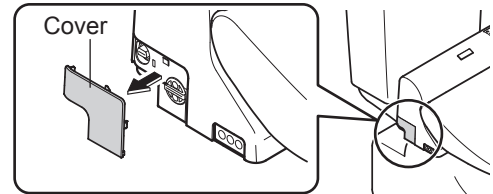

- 5** Clean with a tool such as a toothbrush.

- Also, remove any dust from inside the hole of the water filter drain valve.

- 6** Reinstall the water filter drain valve and cover.

- Insert the water filter drain valve and tighten it securely with a flat-head screwdriver.



- 7** Insert the power plug. (Page 15)

- 8** Open the shutoff valve. (Page 15)

# Changing Settings

## Setting List

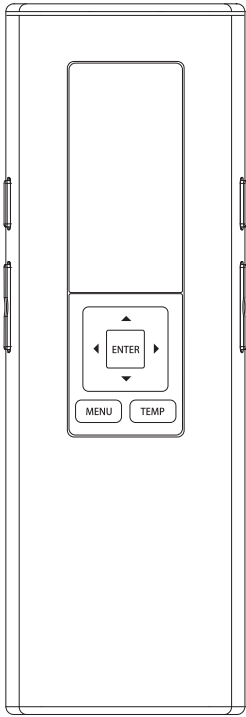

Setting Types		
<b>AUTO FUNCTIONS</b>	<b>CLEANING</b>	<b>DEODORIZER</b>
<b>OTHER SETTINGS</b>	<b>BEEP</b>	
	<b>SETTING LOCK</b>	
	<b>PERSONAL SETTING LOCK</b>	



	Available Settings*	Applicable Models	Setting Ref. Page
<ul style="list-style-type: none"> <li>• Set whether or not to deodorize automatically after sitting on the toilet seat</li> </ul>	ON/OFF	SW542	Page 36
<ul style="list-style-type: none"> <li>• Set whether or not to make a beep sound</li> </ul>	ON/OFF	All models	Page 38
<ul style="list-style-type: none"> <li>• Set whether or not to use the setting lock</li> </ul>	ON/OFF	All models	
<ul style="list-style-type: none"> <li>• Set whether or not to use the personal setting lock</li> </ul>	ON/OFF	All models	

\*The black text is the initial setting.

# Changing Settings

## CLEANING

1  Press [MENU].

2  Use  to select "AUTO FUNCTION" and then press [ENTER].

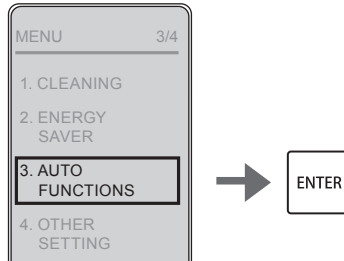

3  Use  to select "CLEANING" and then press [ENTER].



Set whether or not to deodorize automatically after sitting on the toilet seat  
**DEODORIZER**  
(SW542 only)

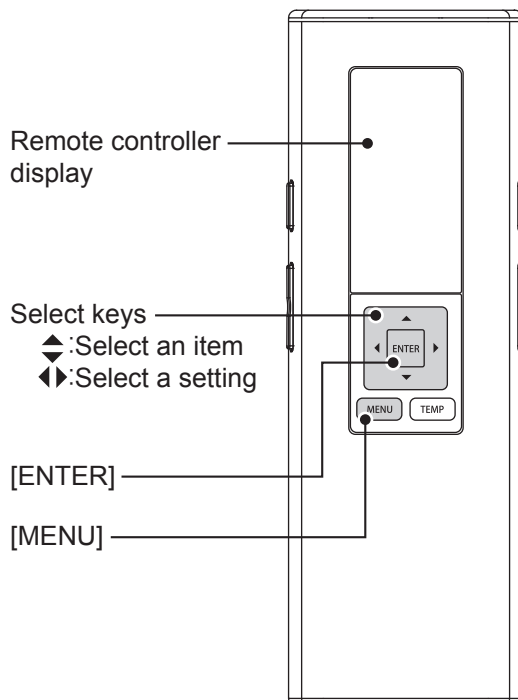

Items set on this display

1.DEODORIZER\*

\* Will not be displayed on SW532 remote control.

4



Use  to select "DEODORIZER".

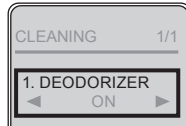

5



Use  to select "ON/OFF" and then press [ENTER].

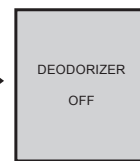
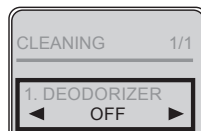



(To return → )

# Changing Settings

## OTHER SETTINGS

**1**  Press [MENU].

**2**  Use  to select "OTHER SETTING" and then press [ENTER].

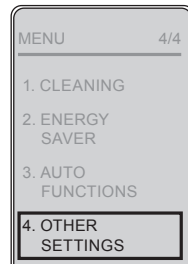

Set whether or not to make a beep sound  
**BEEP**

Set whether or not to use the setting lock  
**SETTING LOCK**

Set whether or not to use the personal setting lock  
**PERSONAL SETTING LOCK**

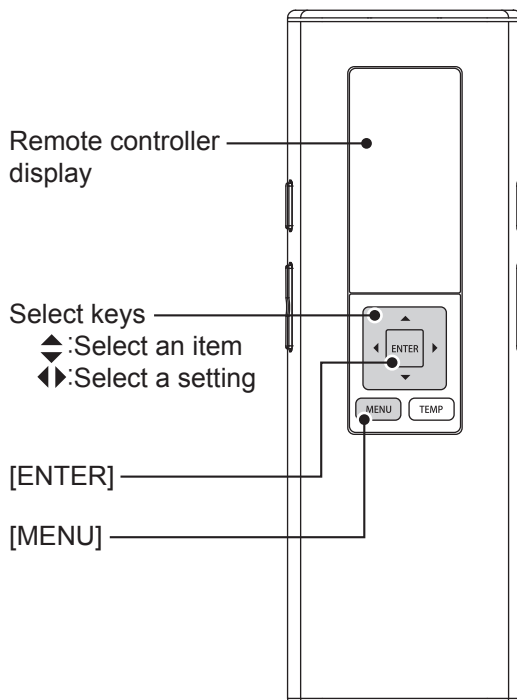

Items set on this display

1. BEEP
2. SETTING LOCK
3. PERSONAL SETTING LOCK

3 Use  to select "BEEP".

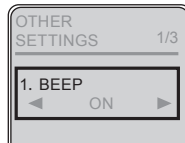

4 Use  to select "ON/OFF" and then press [ENTER].

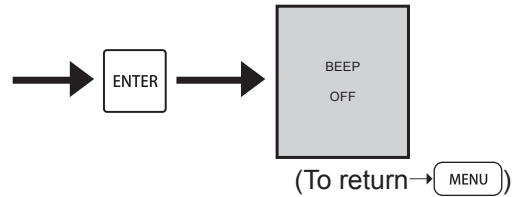

3 Use  to select "SETTING LOCK".



4 Use  to select "ON/OFF" and then press [ENTER].

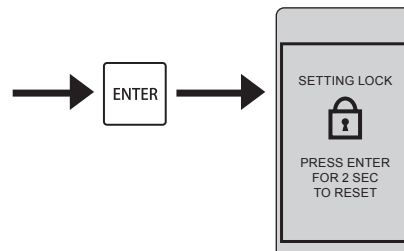

5 Check the displayed screen.

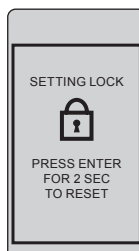



Display screen during setting lock

Cancellation method:  
Press [ENTER] for 2 seconds or longer.

\*If you want to relock after cancellation, reconfigure the setting.

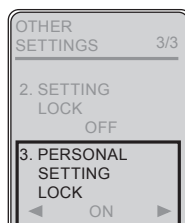
3 Use  to select "PERSONAL SETTING LOCK".



4 Use  to select "ON/OFF" and then press [ENTER].

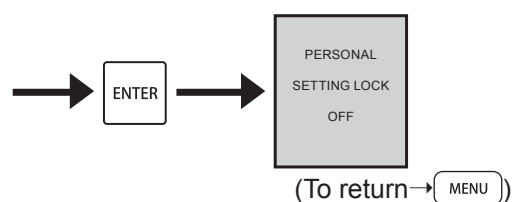
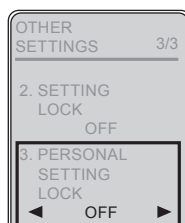



# What to Do?

## If you cannot operate with the remote control

- Operation is also possible using the buttons on the control panel.
- The batteries may have worn out. Replace the batteries.

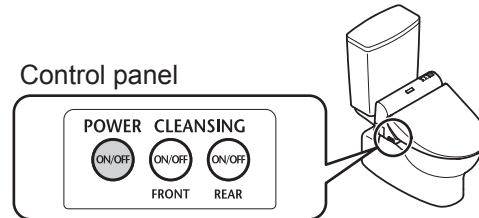

### ■ Replacing the batteries

- 1** Press [POWER ON/OFF] on the control panel.
  - The POWER LED goes off.
- 2** Remove the remote control from the hanger. (Page 14)
- 3** Open the battery cover and replace the AA batteries. (Page 14)
- 4** Mount the remote control in the hanger.
- 5** Press [POWER ON/OFF] on the control panel.
  - The POWER LED lights up.

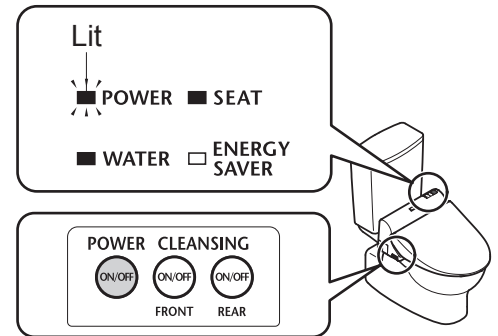

# What to Do?

## Freeze Damage Prevention

When the ambient temperature is likely to drop to 0°C (32°F) or lower, take measures to prevent freezing.

### Attention!

- When the ambient temperature is likely to drop to 0°C (32°F) or lower, do not use the energy saver feature. (May damage the product.)
- Warm the bathroom or take measures against freezing so that the ambient temperature does not drop below 0°C (32°F).

## Freeze damage prevention

### How to drain the water

**1** Close the shutoff valve. (Page 43)

**2** Drain the water from the toilet tank.

- Turn the flush handle of the toilet tank to the full flush side.
- Turn the lever until water flow stops.

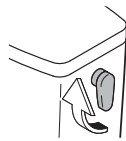

**3** Drain the pipe.

- (1) Extend the wand.
- Operate with the buttons on the back side of the remote control.

1. Press [MENU].

2. Use  to select "CLEANING".

Press [ENTER].

3. Use  to select "WAND CLEANING MODE ON/OFF".

Press [ENTER] to extend the wand.

- Hold the wand in the extended position until no more water comes from around the wand.

Press [ENTER] again to retract the wand. (Release the pressure from the water supply pipe.)

(2) Unplug the power plug. (Page 15)

(3) Remove the cover and water filter drain valve.

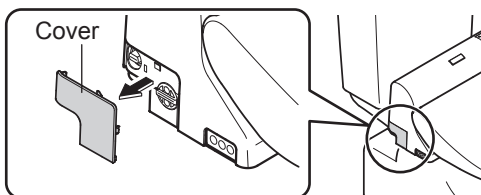

Water filter drain valve

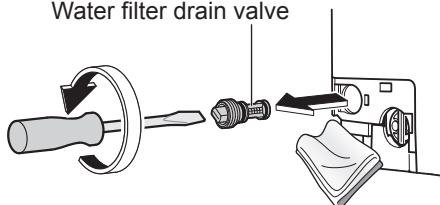

(4) After draining the water, install the water filter drain valve and cover.

- Insert the water filter drain valve and use a flat-head screwdriver to tighten it securely.

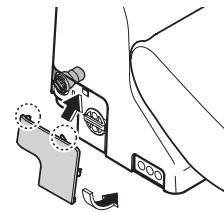

(5) Insert the power plug. (Page 15)

**4** Check that the POWER LED on the main display is lit up. (Page 15)

**5** Set the water and toilet seat temperature to "High" (Page 22) (To maintain the temperature.)

- When finished, close the toilet seat and toilet lid.

### To use the Washlet again

- The water needs to be resupplied. (See below)

## Resupplying the Water (After draining)

**1** Open the shutoff valve.

- Check that water is not leaking from a pipe or the main unit.

**2** Insert the power plug.

**3** Discharge water from the wand.

- (1) Pressing down the right side of the toilet seat,  
(2) Press [REAR] on the remote control for about two minutes to discharge water from the wand. (It takes about one minute before water comes out. Catch the water in a paper cup or other receptacle.)

### If the remaining water has frozen and no water comes out

- Heat the inside of the bathroom, and warm the water supply hose and shutoff valve using a cloth soaked in warm water.

# What to Do?

## Long Periods of Disuse

**If the toilet is in a location you will not visit for a long time, drain the water.**

(The water in the tank may become contaminated and cause skin irritation or other problems.)

### How to drain the water

**1** Drain the water from the toilet tank.  
(Step **1**, **2** on Page 41)

**2** Drain the pipe.  
(Step **3** (1) to (4) on Page 41)

\*After draining water, keep the cover removed.

**3** Remove the water drain plug.  
• The water comes out from near the wand for about 90 seconds.

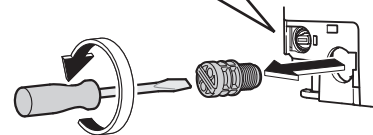
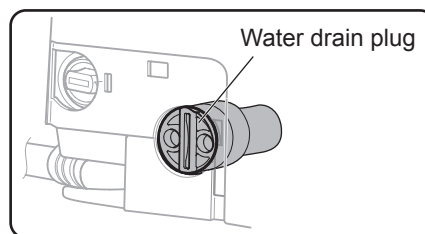

**4** Reinstall the water drain plug and cover.

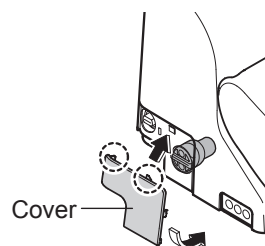
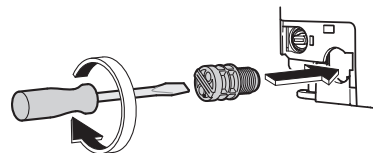

#### ■ If water may get frozen

- Add antifreeze solution in the water in the bowl to prevent freezing.  
(The antifreeze solution should not be flushed out. Collect it before using the toilet and dispose of it.)

#### ■ To use the Washlet again

- The water needs to be resupplied. (Page 41)

# Troubleshooting

First, try the actions described on pages 43 to 46. If the problem persists, consult the installer, seller or the contact listed on the back cover of this manual.

**⚠ CAUTION**

**!** If a water leak occurs, close the shutoff valve.

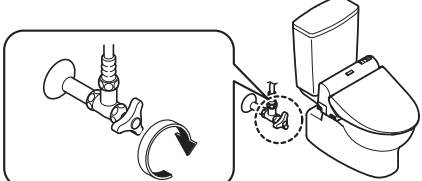

## Please check first

**Is the POWER LED lit?**

- Does the LED light up when you press [POWER ON/OFF] on the main unit?
- Is the breaker on the distribution board turned on?
  - Check whether there is a power outage or the breaker has turned "OFF".

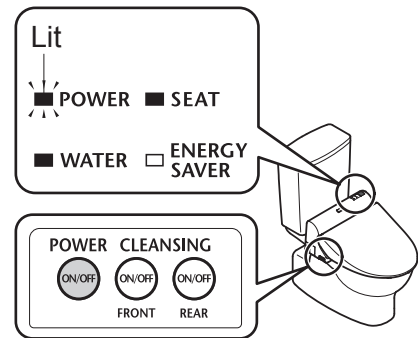

**Is the ENERGY SAVER LED lit?**

- While the LED is lit, energy saver (Page 24) is in operation, so the toilet seat temperature may be reduced or the heater may be turned off.

**Is the remote control working?**

- Are the remote control batteries dead?
  - Replace the batteries. (Page 40)
- Is the remote control transmitter or the remote control receiver blocked?
  - Remove obstructions, dirt, water droplets or any other blockages.

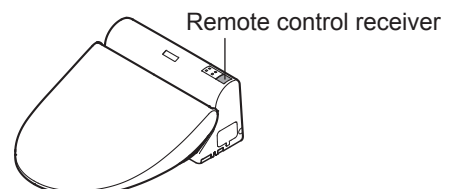
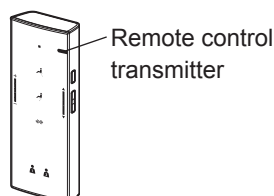
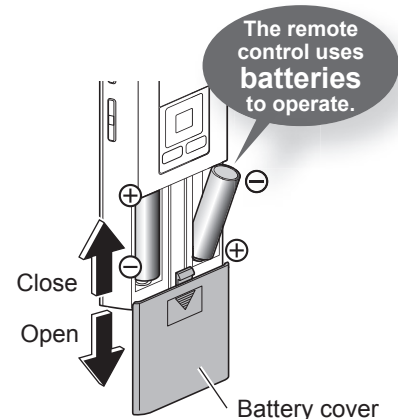

# Troubleshooting

## Rear and front cleansing, wand

Trouble	Please check	Ref. Page
<p><b>The wand (or cleansing water) does not come out</b></p>	<ul style="list-style-type: none"> <li>● Can you operate with the control panel? (Check while sitting on the toilet seat.) → Check "Is the remote control working?"</li> </ul>	<p><b>12</b> <b>43</b></p>
	<ul style="list-style-type: none"> <li>● When the temperature is low, it takes time for the wand to come out after the remote control button is pressed because the water must be warmed up first.</li> </ul>	<p>-</p>
	<ul style="list-style-type: none"> <li>● Did you sit on the toilet continuously for 2 hours or longer? (If so, operation is stopped for safety purposes.) → Stand up from the seat and then use again.</li> </ul>	<p>-</p>
	<ul style="list-style-type: none"> <li>● If the water supply pressure drops significantly, for example if water is used elsewhere or if there is a water failure, the function may stop for safety. → Disconnect the power plug and wait about 10 seconds before inserting it again. If the same symptom reappears → There may be a malfunction. Consult with the contact listed on the back cover of this manual.</li> </ul>	<p>-</p>
	<ul style="list-style-type: none"> <li>● The seat switch may have difficulty detecting some sitting postures. → Sit back on the toilet seat.</li> </ul>	<p><b>11</b></p>
	<ul style="list-style-type: none"> <li>● Are you using a toilet seat cover, a toilet lid cover or a seat for infants? → Remove any covers. When using a seat for infants or a soft highchair, remove after each use.</li> </ul>	 <p><b>11</b></p>
<p><b>The wand extends but the cleansing water does not come out / The cleansing water pressure is weak</b></p>	<ul style="list-style-type: none"> <li>● Has a water failure occurred? → Press the "STOP" button and wait until water service is restored.</li> </ul>	<p>-</p>
	<ul style="list-style-type: none"> <li>● Is the shutoff valve closed?</li> </ul>	<p><b>15</b></p>
	<ul style="list-style-type: none"> <li>● Is the water filter drain valve clogged with foreign matter? → Clean the filter.</li> </ul>	<p><b>33</b></p>
	<ul style="list-style-type: none"> <li>● Is the water pressure set to a low level?</li> </ul>	<p><b>17</b></p>
	<ul style="list-style-type: none"> <li>● Is the water drain plug loosened? → Tighten the water drain plug securely.</li> </ul>	<p><b>42</b></p>
<p><b>The cleansing water is cold</b></p>	<ul style="list-style-type: none"> <li>● Is the water temperature set to "OFF" or a low level?</li> <li>● When the temperature of the water supply or the bathroom is low, the water temperature may be low when first sprayed.</li> </ul>	<p><b>22</b> -</p>
	<ul style="list-style-type: none"> <li>● Is this happening during the period that the timer energy saver is set? → Wait 10 minutes after having sat on the toilet seat.</li> </ul>	<p><b>24</b></p>
<p><b>Stops in the middle of use</b></p>	<ul style="list-style-type: none"> <li>● Rear, rear soft, front and wide front cleansing stop automatically after 5 minutes of continuous use.</li> </ul>	<p>-</p>
	<ul style="list-style-type: none"> <li>● Does the seat switch have difficulty detecting? → Sit back on the toilet seat. If you get up slightly from the seat, or sit forward on the seat, the seating switch may temporarily stop detecting your presence.</li> </ul>	<p><b>11</b></p>
<p><b>Water comes out unexpectedly from the wand</b></p>	<ul style="list-style-type: none"> <li>● Water comes out from the area around the wand for several seconds after you stand up from the toilet seat.</li> <li>● Water may sometimes come out from around the wand when it expands in the warm water tank.</li> </ul>	<p><b>20</b> -</p>

## Warm air drying (SW542 only)

Trouble	Please check	Ref. Page
The dryer temperature is low	<ul style="list-style-type: none"> <li>● Is the remote control preset temperature set to a low level?</li> </ul>	22
Stops in the middle of use	<ul style="list-style-type: none"> <li>● The feature stops automatically after 10 minutes of continuous use.</li> <li>● Does the seat switch have difficulty detecting?                             <ul style="list-style-type: none"> <li>→ Sit back on the toilet seat. If you get up slightly from the seat, or sit forward on the seat, the seating switch may temporarily stop detecting your presence.</li> </ul> </li> </ul>	- 11

## Toilet Seat and Toilet Lid

Trouble	Please check	Ref. Page
The toilet seat does not get warm	<ul style="list-style-type: none"> <li>● Is the toilet seat temperature set to "OFF" or a low level?</li> </ul>	22
	<ul style="list-style-type: none"> <li>● Is the ENERGY SAVER LED (green) lit and is the SEAT LED off?                             <ul style="list-style-type: none"> <li>• Timer energy saver is operating and has turned off the toilet seat heater.</li> <li>→ When you sit on the seat, the heater is turned on temporarily and the seat is warmed in about 15 minutes.</li> </ul> </li> <li>● Is the ENERGY SAVER LED (orange) lit?                             <ul style="list-style-type: none"> <li>• The toilet seat temperature has been lowered to save energy (the auto energy saver in operation).</li> <li>→ When you sit on the seat, the heater is turned on temporarily and the seat is warmed in about 15 minutes.</li> </ul> </li> </ul>	24
	<ul style="list-style-type: none"> <li>● Have you been seated for a long time?                             <ul style="list-style-type: none"> <li>• After about 20 minutes of sitting, the temperature starts going down, and after about 1 hour, the heater is turned "OFF".</li> <li>→ Move away from the toilet seat and then go back.</li> </ul> </li> </ul>	-
	<ul style="list-style-type: none"> <li>● Did you put anything on the toilet seat or the toilet lid?                             <ul style="list-style-type: none"> <li>→ Remove the object from the toilet seat or the toilet lid.</li> </ul> </li> </ul>	-
	<ul style="list-style-type: none"> <li>● The seat switch may have difficulty detecting some sitting postures.</li> <li>→ Sit back on the toilet seat.</li> </ul>	11
	<ul style="list-style-type: none"> <li>● Is a toilet lid or seat cover installed?                             <ul style="list-style-type: none"> <li>→ Remove any covers.</li> </ul> </li> </ul>	11

## Energy Saver

Trouble	Please check	Ref. Page
The timer energy-saver feature is not working	<ul style="list-style-type: none"> <li>● Did you replace the remote control batteries?                             <ul style="list-style-type: none"> <li>• When the batteries are discharged, the settings may be erased.</li> <li>→ Reconfigure the setting.</li> </ul> </li> </ul>	14 26
The auto energy-saver feature is not working	<ul style="list-style-type: none"> <li>● Because the function takes several days learning the usage conditions before starting energy saver, the amount of energy saving may be low, depending on the frequency of use.</li> <li>→ Check the type of energy saver.</li> </ul>	24

# Troubleshooting

## Deodorizer (SW542 only)

Trouble	Please check	Ref. Page
<b>The deodorizer seems to be not working</b>	<ul style="list-style-type: none"> <li>● Even after sitting down, you do not hear operation sounds. → Sit back on the toilet seat.</li> <li>● If you hear an operation sound when you sit on the toilet seat. → Clean the deodorizing filter.</li> </ul>	11 29
<b>A strange odor is emitted</b>	<ul style="list-style-type: none"> <li>● Are you using an air freshener or deodorizer that you purchased separately? <ul style="list-style-type: none"> <li>• Doing so may reduce the effectiveness of the Washlet deodorizer or cause strange odors.</li> </ul> </li> <li>→ Remove the air freshener or deodorizer.</li> </ul>	-
<b>The deodorizer is not working</b>	<ul style="list-style-type: none"> <li>● Is "DEODORIZER" set to "OFF"? → Set to "ON".</li> </ul>	36

## Others

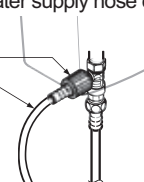
Trouble	Please check	Ref. Page
<b>Water is leaking from the plumbing connections</b>	<ul style="list-style-type: none"> <li>● If any nuts in a connection are loose, firmly tighten them with a tool such as a monkey wrench.</li> </ul> <div style="border: 1px solid black; padding: 5px; margin: 10px 0;"> <p style="text-align: center;">Do not use tools on the water supply hose connection. Tighten it by hand.</p>  </div> <ul style="list-style-type: none"> <li>→ If the water leak does not stop, close the shutoff valve and seek repair.</li> </ul>	-
<b>The display on the remote control goes out</b>	<ul style="list-style-type: none"> <li>● The display goes out when no button on the remote control is pressed for 5 minutes or more.</li> </ul>	14
<b>The main unit is unstable</b>	<ul style="list-style-type: none"> <li>● There is clearance between the toilet seat cushion and the toilet bowl for activating the seat switch. When you sit on the toilet seat, the toilet seat subsides slightly to activate the seat switch.</li> <li>● Are the bolts that anchor the main unit loose? → Remove the main unit and then firmly tighten the base plate bolts.</li> </ul>	11 30

# Specifications

Item			SW542	SW532	
Rated power supply			AC 120V-60Hz		
Rated power consumption			406W	318W	
Type			Warm water accumulation type		
Power cord length			1.2m (3.94ft)		
Water protection level			IPX4		
Functions	Cleansing	Spray volume	Rear cleansing	Approx. 0.29 to 0.60 L/min. (Approx. 0.08 to 0.16 gal/min.) <at 0.20 MPa (29 PSI) water pressure>	
			Rear soft cleansing	Approx. 0.29 to 0.55 L/min. (Approx. 0.08 to 0.15 gal/min.) <at 0.20 MPa (29 PSI) water pressure>	
			Front cleansing	Approx. 0.27 to 0.55 L/min. (Approx. 0.07 to 0.15 gal/min.) <at 0.20 MPa (29 PSI) water pressure>	
		Water temperature	Adjustable temperature range: OFF, about 30°C to 40°C (about 86°F to 104°F)		
		Heater capacity	250W		
		Toilet tank capacity	0.78L (0.21gal)		
		Safety device	Temperature fuse, overheat shutoff switch (bimetal automatic return type), anti-idling float switch		
		Backflow prevention device	Vacuum breaker, Check valve		
	Warm air dryer	Warm air temperature <sup>*1</sup>	Adjustable temperature range : about 40°C to 60°C (about 104°F to 140°F)		-
		Airflow volume	Approx. 0.27m <sup>3</sup> /min (Approx. 9.53ft <sup>3</sup> /min)		-
		Heater capacity	350W		-
		Safety device	Temperature fuse		-
	Heated seat	Surface temperature	Adjustable temperature range: OFF, about 28°C to 36°C (about 82°F to 97°F) <About 26°C (about 79°F) when auto energy saver is in operation>		
		Heater capacity	50W		
		Safety device	Temperature fuse		
	Deodorizer	Method	O <sub>2</sub> deodorization		-
		Airflow volume	Approx. 0.16m <sup>3</sup> /min (Approx. 5.65ft <sup>3</sup> /min)		-
		Power consumption	Approx. 5.8W		-
	Water supply pressure			Minimum required water pressure: 0.05MPa (7.25 PSI) <dynamic>, Maximum required water pressure: 0.75MPa (108.75 PSI) <static>	
	Water supply temperature			0°C to 35°C (32°F to 95°F)	
	Working ambient temperature			0°C to 40°C (32°F to 104°F)	
Dimensions			W 405mm × D 522mm × H 173mm (W 1.33ft × D 1.71ft × H 0.57ft)		
Weight			About 7kg (about 15lb)		

\*1 Temperature around the warm air outlet measured by TOTO.



# Limited Warranty

## One Year Limited Warranty

1. TOTO warrants its washlet series ("Washlet") to be free from defects in materials and workmanship during normal use when properly installed and serviced, for a period of one (1) year from date of purchase. This limited warranty is extended only to the ORIGINAL PURCHASER of the Product and is not transferable to any third party, including but not limited to any subsequent purchaser or owner of the Product. This warranty applies only to TOTO Product is purchased and installed in North, Central and South America.
2. TOTO's obligations under this warranty are limited to repair, replacement or other appropriate adjustment, at TOTO's option, of the Product or parts found to be defective in normal use, provided that such Product was properly installed, used and serviced in accordance with instructions.  
TOTO reserves the right to make such inspections as may be necessary in order to determine the cause of the defect. TOTO will not charge for labor or parts in connection with warranty repairs or replacements. TOTO is not responsible for the cost of removal, return and/or reinstallation of the Product.
3. This warranty does not apply to the following items:
  - a) Damage or loss sustained in a natural calamity such as fire, earthquake, flood, thunder, electrical storm, etc.
  - b) Damage or loss resulting from any accident, unreasonable use, misuse, abuse, negligence, or improper care, cleaning, or maintenance of the Product.
  - c) Damage or loss resulting from sediments or foreign matter contained in a water system.
  - d) Damage or loss resulting from the quality of water in the region where the product is used.
  - e) Damage or loss resulting from improper installation or from installation of the Product in a harsh and/or hazardous environment, or improper removal, repair or modification of the Product. This includes locations where the water pressure is above local codes or standards. (NOTE : Product model codes allow a maximum of 80 PSI. Check local codes or standards for requirements).
  - f) Damage or loss resulting from electrical surges or lightning strikes or other acts which are not the fault of TOTO or which the Product is not specified to tolerate, including failure to use the factory equipped cord and plug or use of a loose or faulty electrical outlet or use of a current or socket other than a 120V, 60Hz electrical current from a GFI (ground, fused) socket.
  - g) Damage or loss resulting from normal and customary wear and tear, such as gloss reduction, scratching or fading over time due to use, cleaning practices or water or atmospheric conditions, including but not limited to, the use of bleach, alkali, acid cleaners, dry (powder) cleaners or any other abrasive cleaners or the use of metal or nylon scrubbers.
4. If the Danger Label which has been placed over the seams on the back of the Product's top unit is broken or otherwise not intact, this limited warranty is void.
5. In order for this limited warranty to be valid, proof of purchase is required. TOTO encourages warranty registration upon purchase to create a record of Product ownership at <http://www.totousa.com>. Product registration is completely voluntary and failure to register will not diminish your limited warranty rights.
6. If the Product is used commercially or is installed outside of North, Central or South America, TOTO warrants the Product to be free from defects in materials and workmanship during normal use for one (1) year from the date of installation of the Product, and all other terms of this warranty shall be applicable except the duration of the warranty.
7. This warranty gives you specific legal rights. You may have other rights which vary from state to state, province to province or country to country.
8. To obtain warranty repair service under this warranty, you must take the Product or deliver it prepaid to a TOTO service facility together with proof of purchase (original sales receipt) and a letter stating the problem, or contact a TOTO distributor or products service contractor, or write directly to TOTO U.S.A., INC., 1155 Southern Road, Morrow, GA 30260 (888) 295 8134 or (678) 466-1300, if outside the U.S.A. If, because of the size of the Product or nature of the defect, the Product cannot be returned to TOTO, receipt by TOTO of written notice of the defect together with proof of purchase (original sales receipt) shall constitute delivery. In such case, TOTO may choose to repair the Product at the purchaser's location or pay to transport the Product to a service facility.

WARNING! TOTO shall not be responsible or liable for any failure of, or damage to, this Product caused by either chloramines in the treatment of public water supply or cleaners containing chlorine (calcium hypochlorite).

NOTE: The use of a high concentrate chlorine or chlorine related product's can seriously damage the fittings. This damage can cause leakage and serious property damage.

THIS WRITTEN WARRANTY IS THE ONLY WARRANTY MADE BY TOTO. REPAIR, REPLACEMENT OR OTHER APPROPRIATE ADJUSTMENT AS PROVIDED UNDER THIS WARRANTY SHALL BE THE EXCLUSIVE REMEDY AVAILABLE TO THE ORIGINAL PURCHASER. TOTO SHALL NOT BE RESPONSIBLE FOR LOSS OF THE PRODUCT OR FOR OTHER INCIDENTAL, SPECIAL OR CONSEQUENTIAL DAMAGES OR EXPENSES INCURRED BY THE ORIGINAL PURCHASER, OR FOR LABOR OR OTHER COSTS DUE TO INSTALLATION OR REMOVAL, OR COSTS OF REPAIRS BY OTHERS, OR FOR ANY OTHER EXPENSE NOT SPECIFICALLY STATED ABOVE. IN NO EVENT WILL TOTO'S RESPONSIBILITY EXCEED THE PURCHASE PRICE OF THE PRODUCT. EXCEPT TO THE EXTENT PROHIBITED BY APPLICABLE LAW, ANY IMPLIED WARRANTIES, INCLUDING THAT OF MERCHANTABILITY OR FITNESS FOR USE OR FOR A PARTICULAR PURPOSE, ARE EXPRESSLY DISCLAIMED. SOME STATES DO NOT ALLOW LIMITATIONS ON HOW LONG AN IMPLIED WARRANTY LASTS, OR THE EXCLUSION OR LIMITATION OF INCIDENTAL OR CONSEQUENTIAL DAMAGES, SO THE ABOVE LIMITATION AND EXCLUSION MAY NOT APPLY TO YOU.





