

HRT MODELS

HRT4806U/ULP | HRT3618U/ULP

COOK LIKE A GOD

THOR
K I T C H E N [®]

USE & CARE MANUAL

USE AND CARE MANUAL

PROFESSIONAL GAS RANGETOPS

HRT MODELS

HRT4806U/ULP | HRT3618U/ULP

THOR
K I T C H E N[®]

THOR KITCHEN GAS RANGETOPS

WELCOME & CONGRATULATIONS

CONGRATULATIONS ON YOUR PURCHASE OF A THOR KITCHEN RANGETOP!

We are very proud of our products and are completely committed to provide you with the best cooking experience. Your satisfaction is our top priority.

Please read through this manual prior to installation, it contains important information to help you properly use & maintain your new gas rangetop.

IMPORTANT NOTE:

Inspect the product and packaging to verify no shipping damage to the product.

DO NOT return this product to the original seller.

Please give us a call, and we will do our best to help you.

THOR KITCHEN GAS RANGETOPS

GAS RANGETOP INSTALLATION

IMPORTANT NOTE:

This installation must be completed by a qualified appliance installer, service company or gas supplier.

Read this entire installation manual carefully prior to installation and save for the local inspector's reference. Keep this installation manual for future reference. If you have any question, please contact our service department immediately for assistance.

The appliance must be installed in accordance with National Electrical Codes, as well as all state, municipal and local codes. The correct voltage, frequency and amperage must be supplied to the appliance from a dedicated, grounded circuit breaker or time delay fuse

Thor Kitchen gas rangetop are manufacture for use with natural gas or liquid propane gas (LP). Features and specifications are subject to change at any time without notice. Visit thorkitchen.com for the most up-to-date information or call us at 877-288-8099 during regular office hour: 9am – 5pm (M-F / PST)

To ensure the safe use of Thor Kitchen equipment, please take note of the following types of highlighted information throughout this guide.

- **IMPORTANT NOTE** Important information that needs your attention.
- **CAUTION** indicate a situation where minor injury or product damage may occur if instructions are not followed.
- **WARNING** states a hazard that may cause serious injury or death if precautions are not followed.



THOR KITCHEN GAS RANGETOPS

WARNING

if the information on this guide is not followed exactly, a fire or explosion may result, causing property damage, personal injury or death.

IMPORTANT INSTRUCTIONS

Installation and service must be performed by a qualified installer, service agency or the gas supplier.

Warranty service must be performed by a Thor Kitchen authorized service partner.

Do not store or use gasoline or other flammable vapors and liquids in the vicinity of this or any other appliance.

A ventilation hood is recommended for use with the Thor Kitchen gas rangetop

In Massachusetts: Installations and repairs must be performed by a qualified or licensed contractor, plumber or gasfitter qualified or licensed by the state, province, or region where this appliance is being installed. Only use gas shut-off valves approved for use within the state, province, or region where this appliance is being installed. A flexible gas connector, when used, must not exceed 3' (.9 m).

WHAT TO DO IF YOU SMELL GAS:

- DO NOT try to light any appliance.
- DO NOT touch any electrical switch.
- DO NOT use any phone in your building.
- Call your gas supplier Immediately from a neighbor's phone. Follow any instructions from the gas supplier for your own safety.
- Call your local fire department if you cannot reach your gas supplier.

THOR KITCHEN GAS RANGETOPS

WARNINGS:

Children should not play with packaging material

Dispose the carton and plastic bags after the range top is unpacked. Cartons covered with rugs, bedspreads, or plastic sheets can become air-tight chambers.

Remove all staples from the carton

Staples can cause severe cuts and destroy finishes if they come in contact with other appliances or furniture.

Carefully read and follow all instructions prior using your new rangetop

Be safety conscious. The preparation of food on a range top requires temperatures that could cause severe burns.

Proposition 65

The California Safe Drinking Water and Toxic Enforcement Act of 1986 (Proposition 65) requires the Governor of California to publish a list of substances known to the State of California to cause cancer or reproductive harm.

Burning of gas can result in exposing low level of listed substances, including formaldehyde, benzene, soot and carbon monoxide. This is caused primarily from the incomplete combustion of natural gas or LP gas. Properly adjusted burners will minimize incomplete combustion. By opening a window, using a ventilating hood or fan can minimized the exposure to these substances.

Proper installation

Thor kitchen gas rangetop must be properly installed and grounded by a qualified technician in accordance with the National Fuel Gas Code ANSI Z223.1-latest edition, and the National Electrical Code ANSI/NFPA No.70-latest edition.

Installation & safety

Ask your dealer to recommend a qualified technician and an authorized repair service. Have the technician familiarize you with the locations of the manual gas shut off valve and gas meter in the event it is necessary to shut off gas supply to the range top during an emergency.

DO NOT REPAIR OR REPLACE any part of the appliance unless specifically recommended by owner's manual or customer service department.

Repair service should be done by Thor kitchen authorized technician/service partner only. This will reduce the risk of personal injury and damage to the product.

THOR KITCHEN GAS RANGETOPS

WARNING!

- DO NOT store any flammable materials near surface burners. The type of materials include paper, plastic and flammable liquids.
- Do not store explosives, such as aerosol cans, on or near the range top
- Failed to follow this owner's manual could lead to serious injury or damage to the product

WARNING!

DO NOT TOUCH SURFACE BURNERS OR AREAS NEAR THESE BURNERS Surface burners may be hot after use, even though the flame is not visible or contact the surface directly. Areas near surface burners may become hot enough to cause burns during and after use. Do not let clothing or other flammable materials to contact with areas near surface burners until they have had sufficient time to cool down.

WARNING!

NEVER use this appliance as a space heater to heat or warm the room. Doing so may result in carbon monoxide poisoning.

THOR KITCHEN GAS RANGETOPS

INSTALLATION INSTRUCTIONS

Be sure the range top is properly installed and grounded by a qualified technician. It is the responsibility of the technician to make certain that your range top is properly installed. Situations caused by improper installation are not covered under the warranty. Any expenses incurred due to such situations will not be paid by the manufacturer of the range top. Leak testing of the appliance shall be conducted according to the manufacturer's instructions, or according to local building codes and gas regulations in your area.

GAS CONNECTIONS (All Units)

NOTICE TO MASSACHUSETTS APPLIANCE DEALERS:

Be sure this document is included in all gas range top appliances sold to consumers in the State of Massachusetts.

NOTICE:

Massachusetts law requires the following:

- Appliances must be installed by a licensed plumber or gas fitter.
- Appliances must be connected with a three (3) foot (36" maximum length) flexible gas connector and a "T" handle type manual gas valve in the gas • supply line to the appliance.

Have the dealer where you purchase your new range top install it or have them recommend a qualified installer. Installation must conform with local codes. In the absence of local codes, the installation must conform with the National Fuel Gas Code, ANSI Z223.1-Latest Edition in the U.S.A. or the CAN/CGA B149.1 or .2 Installation Codes in Canada.

The range top should be connected to the supply line with 1/2-inch black iron pipe or a certified flexible type stove connector. To prevent gas leaks, put an approved sealing compound which is resistant to liquefied petroleum gases on all threaded connections.

Important: Do not apply pressure directly to the range top manifold pipe when tightening supply connections. The manifold pipe should be held securely at the pressure regulator to prevent twisting. Hold the pressure regulator with a wrench during the tightening of the connection, or the manifold pipe may be twisted and split and cause a dangerous leak.

The installation of range tops designed for manufactured (mobile) home installation must conform with the Manufactured Construction and Safety, Title 24 CFR, Part 3280, [formerly the Federal standard for Mobile Home Construction and Safety, Title 24, HUD (Part 280)] in the U.S.A. or C.S.A. Standard CAN/CGA Z240.4.2 in Canada or, when such standards are not applicable, with local codes.

THOR KITCHEN GAS RANGETOPS

The installation of range tops designed for recreational vehicle installation must conform with state or other codes or, in the absence of such codes, with the standard for recreational vehicles. ANSI A119.2.2-1982 in the U.S.A. or CAN/CGA Z240.4.2 in Canada.

The installation of appliances designed for recreational park trailers must conform with state or other codes or, in the absence of such codes, with the standard for recreational park trailers, ANSI A119.5.

Note: Check all piping connections in the unit for leaks. Never use an open flame to check for gas leaks. Use a soap solution, 75% water, 25% dish washing soap. It is possible for connections made at the factory to leak, due to vibration encountered in transportation. Make certain you have checked them all, and repair any connections that leak.

The appliance and its individual shut-off valve must be disconnected from the gas supply piping system during any pressure testing of that system at test pressures in excess of 1/2 psig.

The appliance must be isolated from the gas supply piping system by closing its individual manual shutoff valve during any pressure testing of the gas supply piping system at test pressures equal to or less than 1/2 psig.

GAS LINE SHUT-OFF VALVE

- To reduce the possibility of gas leaks, apply Teflon tape or a thread compound approved for use with LP or Natural gases to all threaded connections.
- Install a manual gas line shut-off valve in the gas line in an easily accessed location outside the range in the gas piping external to the appliance for the purpose of turning on or shutting off gas to the appliance.
- Install male 1/2" (30 or 36 inch rangetop) or 3/4" (48 inch range top) flare union adapter to 1/2" or 3/4" NPT internal thread elbow at inlet of regulator. Use a wrench on the regulator fitting to avoid damage.
- Install male 1/2" or 3/4" flare union adapter to the NPT internal thread of the manual shut-off valve, taking care to secure the shut-off valve to keep it from turning.
- Check for leaks using a leak detector or soapy water, 75% water, 25% dish washing soap.

INSTALLATION / CLEARANCES

All units must be installed in accordance to minimum rear and side wall clearances and clearances extended vertically above cooking top which are stated on the serial plate (the serial plate is located on the back of the unit.)

Make sure that the wall coverings, counter tops and cabinets around the range top can withstand temperatures of up to 200 °F/93 °C generated by the range top. It is the responsibility of the installer to make certain that the range top is properly adjusted at the time of installation. Situations caused by improper adjustments or improper installation are not covered under the warranty. Any expenses incurred due to such situations will not be paid by the manufacturer of the appliance.

THOR KITCHEN GAS RANGETOPS

GAS RANGETOP SPECIFICATIONS

Installation without a range hood

Note: All the measurement was based on 24" (61 cm) deep cabinet

This range top may be installed directly adjacent to existing 36" (91.4 cm) high base cabinets.

- The range top CANNOT be installed directly adjacent to sidewalls, tall cabinets, tall appliances, or other side vertical surfaces above 36" (91.4 cm) high. There must be a minimum of 6" (15.2 cm) side clearance from the Range top to such combustible surfaces above the 36" (91.4 cm) counter height.
- Within the 6" (15.2 cm) side clearance to combustible vertical surfaces above 36" (91.4 cm), the maximum wall cabinet depth must be 13" (33.0 cm) and wall cabinets within this 6" (15.2 cm) side clearance must be 18" (45.7 cm) above the 36" (91.4 cm) high counter top.
- Wall cabinets above the range top must be a minimum of 42" (106.7 cm) above the range top cooking surface for the full width of the rangetop. This minimum height requirement does not apply if arange top hood is installed over the cooking surface.



**ITEM OF INTEREST TO CHILDREN SHOULD NOT BE PLACED IN CABINETS ABOVE THE COOKTOP
-CHILDREN CLIMBING ON THE COOKTOP TO REACH ITEMS CAN BE SERIOUSLY INJURED**

THOR KITCHEN GAS RANGETOPS

Installation with a range hood

Note: Minimum clearance for back wall is 0" with backsplash (backguard) or high shelf.

If a range hood is installed above the range top, maintain a 30" (76.2 cm) minimum clearance between the rangetop and the bottom of the range hood. The range hood must exhaust outside. For best smoke elimination, the minimum clearance of the range hood should be installed 30" to 36" above the rangetop surface. Recommended CFM should be 600 CFM for the 30" range top. Do not install with a downdraft ventilation system

Installation in an island

Note: There must be a minimum of 6" (15.2 cm) clearance from rear of range top to a combustible wall. Clearances from non-combustible materials are not part of the ANSI Z21.1 scope and are not certified by CSA. Clearances to non-combustible materials must be approved by the authority having jurisdiction.

- This range top may be installed directly adjacent to existing 36" (91.4 cm) high base cabinets.
- The range top CANNOT be installed directly adjacent to sidewalls, tall cabinets, tall appliances, or other side vertical surfaces above 36" (91.4 cm) high. There must be a minimum of 6" (15.2 cm) side clearance from the range top to such combustible surfaces above the 36" (91.4 cm) counter height.
- Within the 6" (15.2 cm) side clearance to combustible vertical surfaces above 36" (91.4 cm), the maximum wall cabinet depth must be 13" (33.0 cm) and wall cabinets within this 6" (15.2 cm) side clearance must be 18" (45.7 cm) above the 36" (91.4 cm) high countertop.
- Wall cabinets above the range top must be a minimum of 42" (106.7 cm) above the range top cooking surface for the full width of the range top. This minimum height requirement does not apply if a range top hood is installed over the cooking surface.

THOR KITCHEN GAS RANGETOPS

ELECTRICAL REQUIREMENTS

Thor Kitchen Gas Rangetop requires 110 volts, 50/60 Hz electrical supply to operate the ignition system.

The power cord is a 3-prong grounding plug. The plug must be plugged into a mating outlet.

Make sure there is a power outlet within the reach of the range top's power supply cable (within 36 "/30 cm from the right side of the range top). The outlet should be accessible with the range top installed.

Thor Kitchen Gas Rangetop must be properly grounded for safe operation. DO NOT ground the rangetop to any of gas line/ gas pipe.

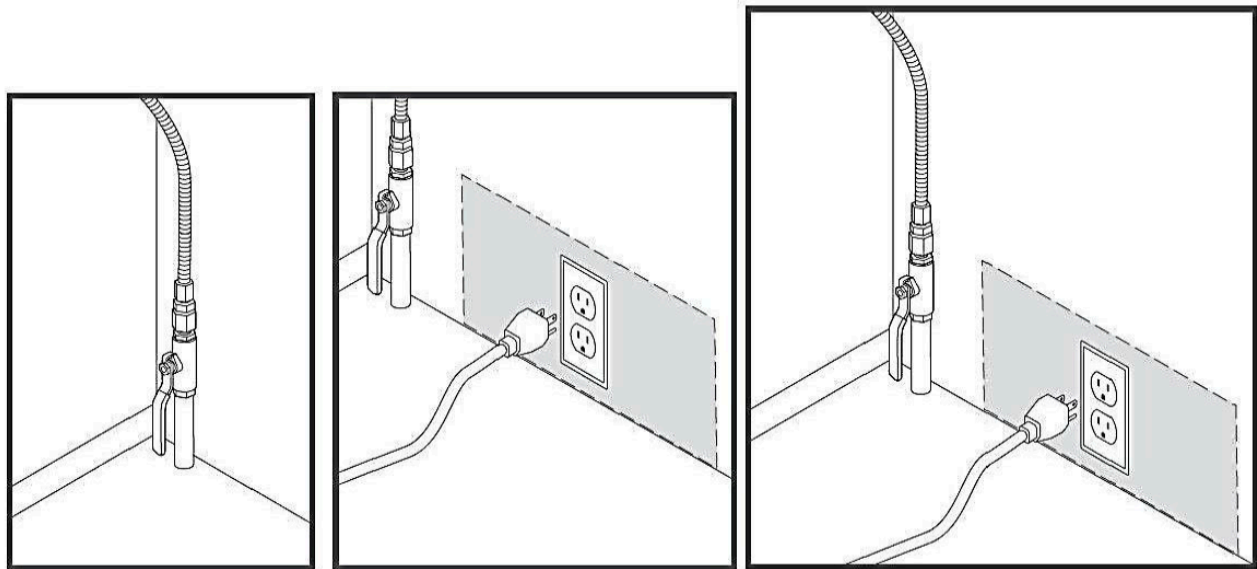

THOR KITCHEN GAS RANGETOPS

PRODUCT DIMENSION

Make sure the counter top cut-out follow the dimensions given in the illustration below. The cabinetry material below rangetop must be non-combustible material.

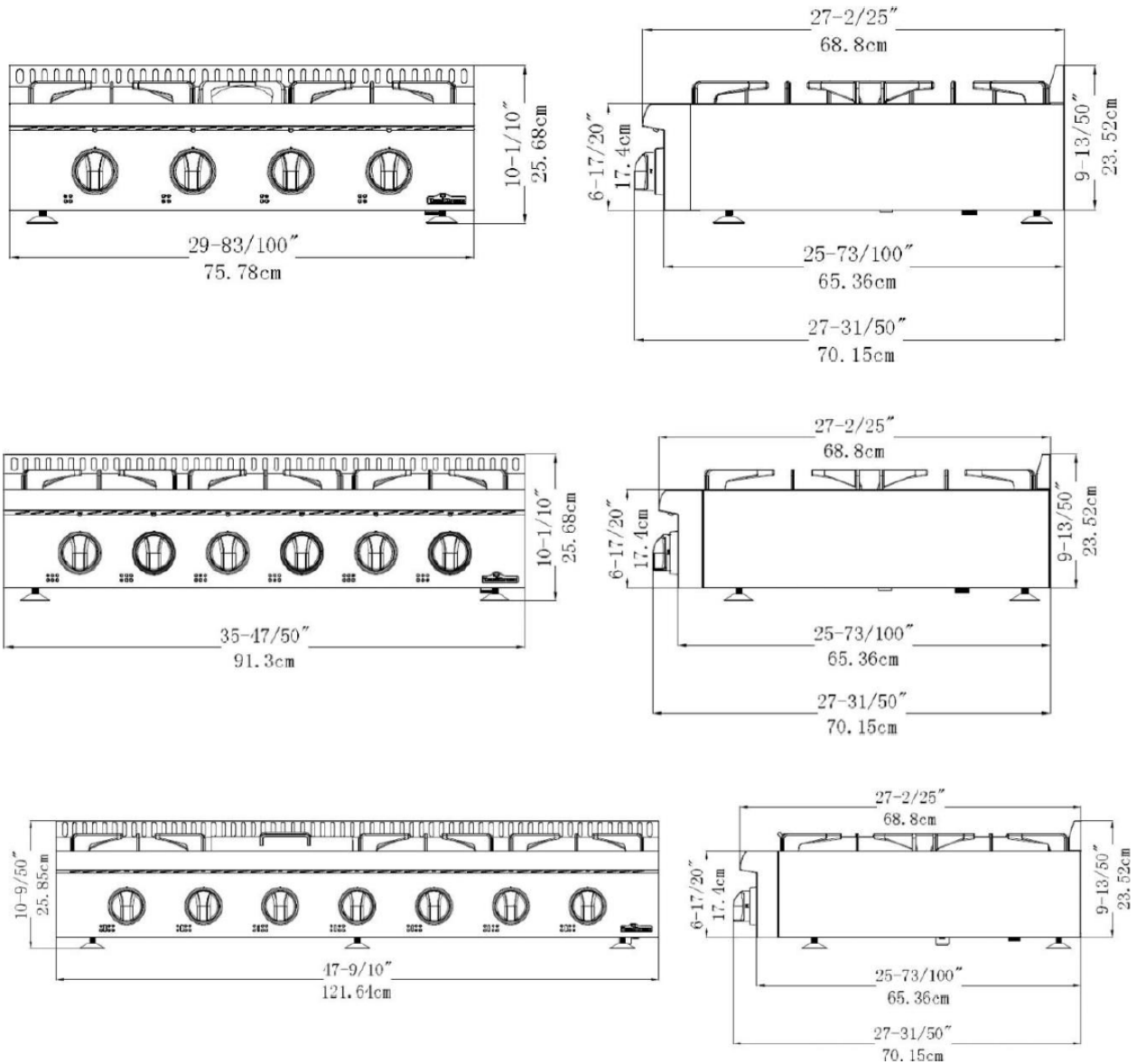

THOR KITCHEN GAS RANGETOPS

RANGETOP INSTALLATION

- Installation and service must be performed by a qualified installer, service agency or the gas supplier.
- Remove the rangetop from its package and set aside all burners, burner caps and cooking grates.
- Gently slide in the range top half into the cut-out, make sure your gas connection and electrical power plug are properly installed.
- Once this is done you're now ready to slide the rangetop all the way back to the wall.
- Install all burners and burner caps
- Install all grates.

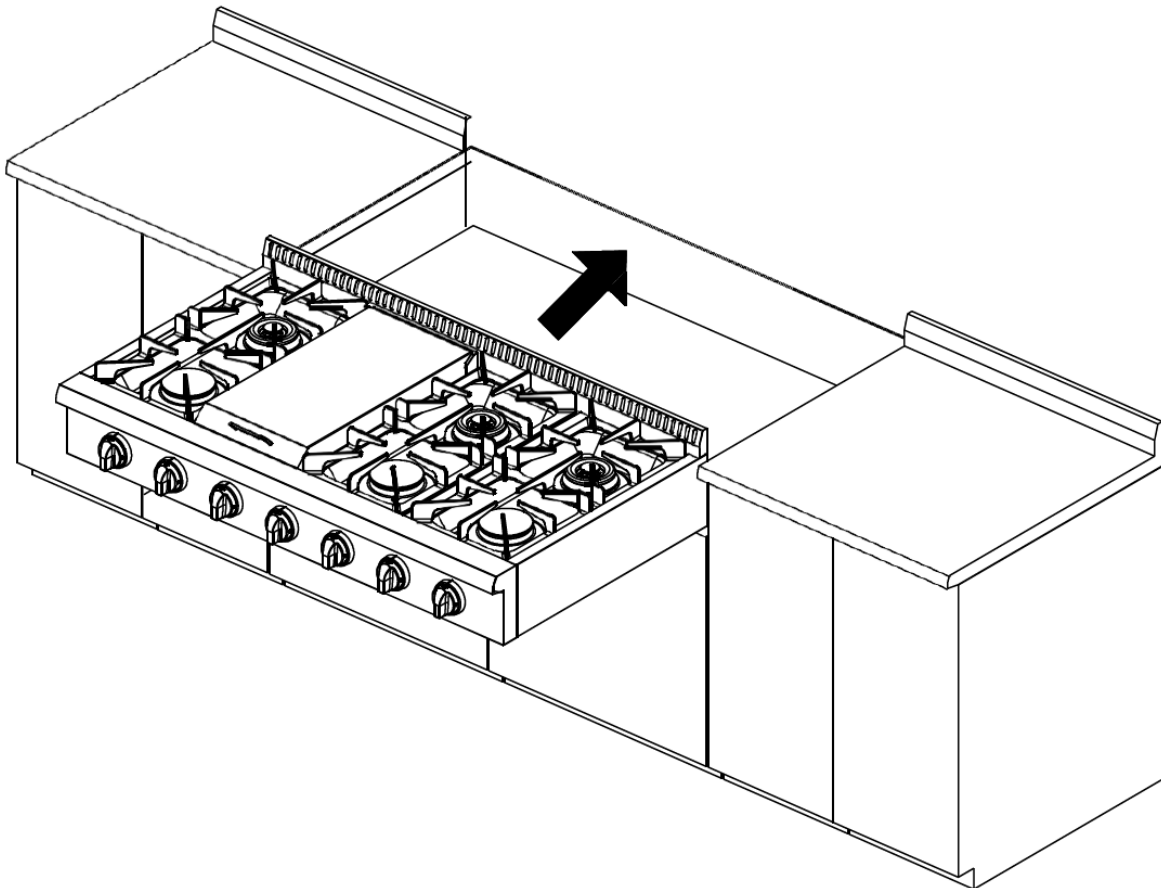

THOR KITCHEN GAS RANGETOPS

CONNECTING GAS TO RANGE TOP

This range top is designed to operate at a pressure of 4" of water column on natural gas or 10" of water column on propane gas (LPG).

This rangetop can be convert for use on Liquid propane gas (LPG). When using this range top on LPG gas, conversion must be made by a qualified installer before attempting to operate the range top on that gas. LP kit can be purchase from authorized Thor Kitchen dealer or contact customer service for further assistant.

For correct operation, the pressure of natural gas supplied to the regulator should be between 4" and 5" of water column. For LP gas, the pressure supplied must be between 10" and 12" of water column.

When checking for correct operation of the regulator, the inlet pressure must be at least 1" more than the operating manifold pressure as given above.

The pressure regulator located at the inlet of the range top manifold must remain in the supply line regardless of Natural (NG) or Liquid Propane (LP) gas is being used.

A flexible metal appliance connector used to connect the range top to the gas supply should be 3 feet/91.4 cm max. in length for easy installation. In Canada, flexible connectors should be single wall metal connectors less than 6 feet/182.9 cm in length.

Shut off the main gas supply valve before removing the old cooking appliance (if applicable) and leave it off until the new hook-up has been completed. Don't forget to relight the pilots on other gas appliances when you turn the gas back on.

Because hard piping restricts movement of the range top, the use of a CSA certified flexible metal appliance connector is recommended unless local codes require a hard-piped connection. Never reuse an old connector when installing a new range top. If the hard piping method is used, you must carefully align the pipe.

To prevent gas leaks, use pipe joint compound resistant to NG gases on all male external pipe threads.

1. In an easily accessible location, install a service manual gas shut off valve. Be sure everyone operating the range top knows where and how to shut off the gas supply to the cook top.
2. Use a flexible gas line to connect to the 1/2" fitting, located on the bottom right hand corner underneath the range top.
3. When all connections have been made, be sure all range top controls are in the off position and turn on the main gas supply valve. Check for gas leaks by using a 75% water, 25% dish washing soap solution. If a gas leak is present, shut off gas immediately, tighten all connections, and retest for leaks.

THOR KITCHEN GAS RANGETOPS

Any opening in the wall behind the appliance and in the floor under the appliance shall be sealed.

GUIDELINES FOR USING RANGE TOP BURNERS

There are dual burners have the same low turn-down setting (SIM) for gentle simmering (620 BTU/hr). Use the SIM setting for melting chocolate and butter, cooking rice and delicate sauces, simmering soups and stews, and keeping cooked food hot.

Never leave the range top unattended when in use. Boil over causes smoking and greasy spills that may ignite.

Never allow flames to extend beyond cookware or curl up its sides. This could discolor and damage the utensil and you may get burned touching a hot handle.

Keep handles out of the way. Turn handles so that they don't extend over the edge of the range or another burner that is on.

Take care when deep-frying. Oil or fat can overheat very quickly, particularly on a high setting.

Make sure that all burner parts are properly in place. Incorrectly or incompletely assembled burners may produce dangerous flames. See 'Replacing the burner parts' in 'Care and cleaning'.

Keep the burners clean. Especially after a spill or boil over, make sure you clean the affected burners before using them again. Food residue may clog the igniter and the notches of the flame spreader, stopping the burner from functioning correctly. See 'Care and cleaning' for instructions.

Check that the burner flames are regular. They should be blue with no yellow tipping, and burn without fluttering all around the burner cap. If not, see 'Troubleshooting' for advice.

THOR KITCHEN GAS RANGETOPS

SURFACE BURNER IGNITION

To light the top burners, push and turn the appropriate control knob counter clockwise to the “HI” position. You will hear a clicking noise the sound of the electric spark igniting the burner. Once burner ignition has been achieved, then turn the burner control knob to adjust the desired heat setting.

NOTE: When one burner is turned to the “HI” position, the burner igniters will park. Do not attempt to disassemble or clean around any burner while another burner is on. Do not touch any burner cap, burner base, or igniter while the igniters are sparking.

FOR THE MODELS WITH GRIDDLE

Before Using the Griddle

1. Clean the griddle thoroughly with warm, soapy water to remove dust or any protective coating.
2. Rinse with clean water and wipe off to dry with soft, clean, lint-free cloth.
3. A stainless steel cover that is sized to fit on top of the surface when the griddle is not being used is provided. Please note that the cover must be removed before turning the griddle on.
4. Make sure the grease tray is under the front edge of the griddle. Position the tray under the griddle overhang to catch grease or food residue.

USE OF THE GRIDDLE

1. Push and turn the control knob counter-clockwise to the preferred cooking temperature.
2. Preheat the griddle for 10-12 minutes.
3. When the griddle is preheated to the desired temp., the indicator light will turn on.
4. Butter or cooking oil can be added for more flavor, then plate the food to cook.

The surface of the griddle is hot after use. Please allow sufficient time for the griddle to cool prior to cleaning.

THOR KITCHEN GAS RANGETOPS

TROUBLESHOOTING TIPS

Symptom	Possible Cause	Solution
Burners will not light.	Burner parts or igniters may be wet, dirty or misaligned.	Check that the burner parts are clean, dry and correctly assembled. Check that the igniters are clean and dry.
Top burner will not stay lit	Failed thermocouple	Replace thermocouple
Flames do not burn all around the burner cap.	Burner parts may be dirty or misaligned.	See “Care and Cleaning” instructions.
Burner flames are very large and yellow.	Burner bezel ports are clogged. Burner ports or burner caps are not positioned properly. Range top is being operated with the wrong type of gas. Regulator is not Installed, is faulty, or is set for the wrong type of gas.	Clean burner bezel ring ports with straightened paper clip, needle, or wire. Remove and carefully re-install burner bezel and caps. Ensure that the type of range top matches the gas supply. Check installation, replace regulator, or set regulator for proper gas.
Igniters are sparking but burners are not igniting.	Gas shut-off valve is in the “OFF” position.	Turn shut-off valve to the “ON” position.

THOR KITCHEN GAS RANGETOPS

Symptom	Possible Cause	Solution
Burner flame goes out at low setting.	<p>Low gas pressure.</p> <p>Air intake holes around burners are obstructed.</p>	<p>Contact gas company.</p> <p>Remove obstruction from air intake holes.</p>
The flames have suddenly gone out.	<p>A draft or spill has extinguished the flame.</p>	<p>Turn the burners off, cleaning the burners And sump area. Once clean reignite top burners.</p>
No ignition spark	<p>Dead batteries or ignition module failed.</p> <p> CAUTION</p>	<p>Replace batteries and attempt ignition. If There is still no spark ignition, the range top burners can still be used.</p> <p>To light them:</p> <ol style="list-style-type: none"> 1.) Holding a lit match to the flame spreader, push in on the control knob and turn counter clockwise to LIGHT. 2.) When the flame is burning all the way around the burner, you may adjust the heat.
“Cracking” or “popping” sound is heard coming from rangetop	<p>This is the sound of metal heating and cooling.</p>	<p>This is normal.</p>

THOR KITCHEN GAS RANGETOPS

WARRANTY AND SERVICE

This product has been manufactured by Thor Group, 4651 E Airport Drive, California 91761

For Customer Service, please call (877) 288 - 8099

For the most up to date warranty and service policy, please refer to our website
WWW.THORKITCHEN.COM/WARRANTY-REGISTRATION

For in-warranty service requests, please visit our website at
WWW.THORKITCHEN.COM/SERVICE

Please Note: You must provide proof of purchase or installation date for any in-warranty service requests

RUBBER PAD INSTALLATION ON BACK PANEL

To Prevent the range too close to the wall, there are 2 plastic pads offered with the user's manual, please find the accessories and follow the below steps:

1. check the installation kit packed with manual.

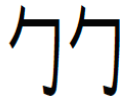

2* screws



2* rubber pad

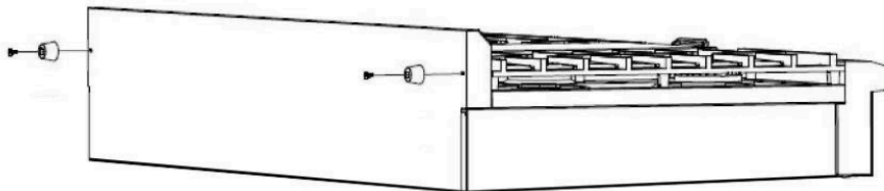

2. Install the 2 rubber pad as showed above.

APPENDIX

Thanks for choosing our Product. Your 48-inch Range top may have KD adjustable feet that need to be installed. Please follow up the procedures below for the feet installation.

1. Find the 6 pieces of adjustable feet inside the package.

Part# 05.01.000053-000-A0

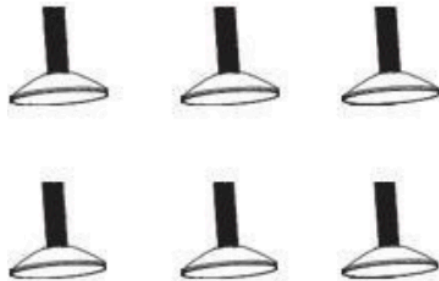

2. Arrange the Range top on the ground with soft material protection. Set aside all the cooking grates, burners and griddle cover to avoid any potential damage.

3. Lift up the front side of the range top, and then install the front three legs;

4. Lay down the Range top on the ground, then lift the back side to install the back three legs.

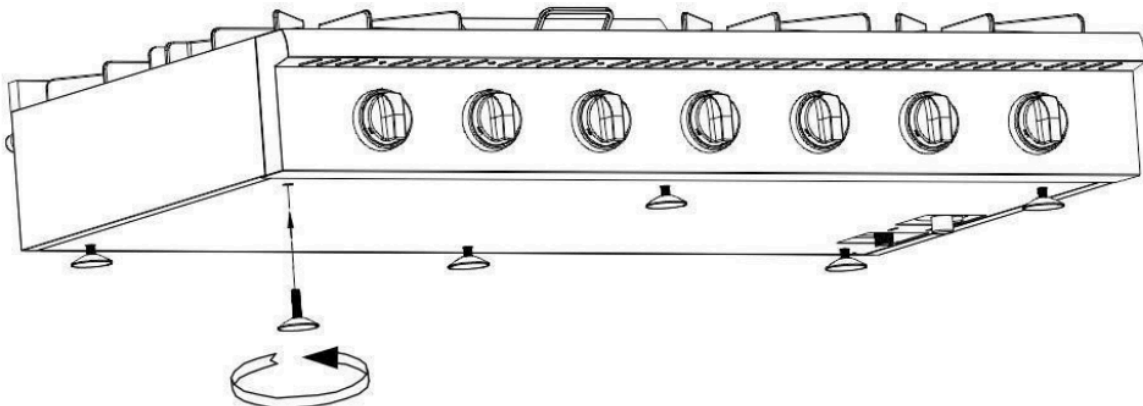

Please Note that All the legs should be installed by turning counterclockwise.

WELCOME TO THE CLUB

You chose THOR Kitchen to enhance your culinary journey and we're stoked to have you in the club. Think of it as a secret society of really savvy people, such as yourself, choosing professional power and performance at an affordable price.



Register your product by following the steps below.

WARRANTY REGISTRATION



Scan the QR code or visit
thorkitchen.com/warranty



Input your product info
and select register



You're done.
Let's get cookin'.

WARRANTY



NEED PARTS?

