



Installation Instructions

Day Spa Generator

If you are a plumber installing this unit, please leave this owner’s manual & warranty card with the owner when you finish the installation.

This instruction supercedes all previous information provided by ThermaSol

Thank You!

CONSUMER WARNING

- DO NOT USE THIS PRODUCT UNLESS YOU HAVE CONSULTED YOUR DOCTOR AND RECEIVED WRITTEN PERMISSION TO DO SO. USE OF THIS PRODUCT MAY BE HAZARDOUS TO YOUR HEALTH.
- STEAM IS HOT! DO NOT TOUCH OR GO NEAR THE STEAMHEAD FROM THE TIME THE UNIT IS “ON”, UP TO ONE HOUR FROM THE TIME THE UNIT IS OFF. SEVERE BURN WILL OCCUR IF YOU COME IN CONTACT WITH THE STEAMHEAD OR STEAM EMITTING FROM THE STEAMHEAD.
- NEVER ATTEMPT TO FILL AROMA THERAPY RESERVOIR ON THE STEAMHEAD WHEN UNIT IS IN THE “ON” POSITION. SEVERE BURNS WILL OCCUR.
- DO NOT USE THERMASOL AROMA THERAPY OILS OR SKIN CARE PRODUCTS OR ANY PRODUCT IN CONJUNCTION WITH YOUR THERMASOL UNIT WITHOUT CONSULTING WITH YOUR ALLERGIST OR DOCTOR BEFORE USE. THESE PRODUCTS MAY BE HAZARDOUS TO YOUR HEALTH.
- YOUR SHOWER MAY BE A SLIP AND FALL HAZARD CHECK WITH YOUR CONTRACTOR OR FLOORING MANUFACTURER REGARDING THE SAFE USE OF YOUR FLOORING IN A STEAM APPLICATION. SLIPPING AND FALLING INTO THE STEAMHEAD ITSELF OR INTO THE STREAM OF STEAM EMITTING FROM THE STEAMHEAD WILL CAUSE SERIOUS BURNS, OR PHYSICAL INJURY.
- DO NOT USE STEAM ROOM WHILE UNDER THE INFLUENCE OF ALCOHOL OR DRUGS, AS THIS CAN BE HAZARDOUS TO YOUR HEALTH.
- IF YOU ARE FEELING UNCOMFORTABLE, DIZZY, FAINT, OR STARTING TO FALL ASLEEP IMMEDIATELY EXIT THE STEAM ROOM.
- DO NOT USE STEAM ROOM IF YOU ARE UNDER THE AGE OF 16 UNLESS SUPERVISED BY AN ADULT.

Note: Before contacting Customer Service for Technical Support, please have the model number, serial number and date code include all numbers and letters.

PLACE SERIAL # HERE

DATE
CODE
HERE

Headquarters & Technical Support
1958 Steam Way, Round Rock, TX 78665 – (800) 776-0711
Mon – Fri 7:00 – 7:00 CST

**** NOTICE ****

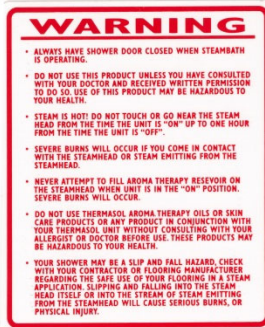

YOU MUST ATTACH THE USER WARNING LABEL IN THE SHOWER NEXT TO THE CONTROL UPON COMPLETION OF INSTALLATION.

LOCATE THE STEAM HEAD 6" INCHES BELOW CEILING AND 6 INCHES FROM NON BENCHED/SEATED/DOOR INTERIOR WALL CORNER. STEAM HEAD IS TO BE MOUNTED AS FAR AS POSSIBLE FROM TYPICAL BATHING POSITION (SEATED OR STANDING) AND AS FAR FROM CONTROL AS POSSIBLE WHILE MAINTAINING APPROXIMATELY A – 60" CONTROL HEIGHT.

Sizing Your Steam Room

Factory Sized: L x W x H = Cubic Feet

Then choose the appropriate Model. No complicated formulas. It's that simple. For every foot of ceiling height over 8 ft. (always round up) use the next larger steam unit. Wall material irrelevant.

Generator Model	Factory Sized Cu Ft MAX	KW
Day Spa 150	150	10
Day Spa 250	250	12
Day Spa 400	400	16
Day Spa 650	650	20

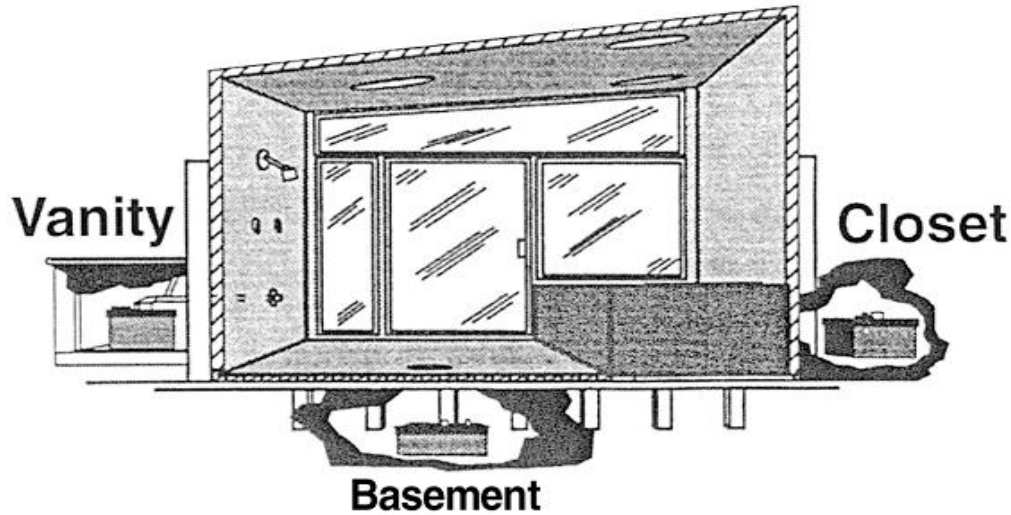

Figure 1

Various options for the ThermaSol steam bath generator location.

Important: **MAXIMUM** WATER PRESSURE not to exceed 70 P.S.I.

Warning: The Steam heads are **HOT!** Do not install Steamhead near a seat or bench hot steam will burn you. Keep at least 12-14 inches away from hot steam exiting the Steamhead.

Requirements for Proper Installation

1. Ensure the steam rooms to be used are vapor proof. They should have a vapor proof door that seals well so the steam does not escape. Make sure the walls, ceiling and floor materials are suitable for use with steam and hot condensation, the steam produces.
2. Unit may be installed up to 50 feet away from steam room and 6 feet away from the steam distribution unit in a dry well ventilated area.
3. Use copper or brass fittings only (**NEVER USE GALVANIZED FITTINGS**).
4. The water inlet uses 3/8" NPT and steam outlet uses 1/2" NPT for easy installation.
5. The generator must be upright, accessible and on a level surface with all connections on top. Access panel must be unobstructed and allow for easy access (**see Figure 1 & 2**).
6. Place a drain/spill pan under the unit. Plumb the connection on it to an approved drain.
7. Connect a tee to the cold water line. Install copper pipe to the tee (**see Figure 3**).
8. Install a brass shut-off valve on the water inlet line in an accessible area prior to the brass union and recommended in-line water filter.
9. Before making the last connection to the 3/8" NPT, flush the water line into a five-gallon pail to remove any silt or other materials that may be in the line.
10. Make the final connection and turn on water. All ThermaSol generators are equipped with an automatic water fill system. The water will stop after unit is filled.
11. The steam line can run up, down, or horizontal; **but cannot run down and then up**. If it does, a steam trap will be produced at the low point blocking the flow of steam. **Do not** plumb a trap in the steam line. Insulate the steam outlet piping if the piping run exceeds 10 feet or is exposed to cold areas. **Note: Use steam rated insulation.**
12. **Do not** plumb the pressure relief valve into the steam line. **Plumbing the pressure relief valve into the steam line can be hazardous, should the steam outlet be capped off or obstructed.**
13. Pitch/angle steam line back towards generator and avoid perfectly level plumbed lines.
14. Make sure water is turned on before operating the unit.
15. The generator has to be installed below the steam distribution unit.
16. Testing the generator will be done when steam distribution system is connected to the generator.

NOTE: Do not attempt to operate Generator without a Steam Distribution unit connected to it.

NOTE: The Generator should only be wired to its own separate breaker after the Generator & Steam Distribution System have been properly located and installed.

Note: Failure to follow installation instructions specifically will cause the warranty to be void.

Generator Installation Instructions

Parts Enclosed

- Steam generator
- Installation Instructions
- Warranty card
- User Warning Label
- Smitty Pan

All ThermaSol steam generators are designed to build NO PRESSURE during operation. This is for your safety.

Note: Failure to follow installation instructions specifically will cause the warranty to be void.

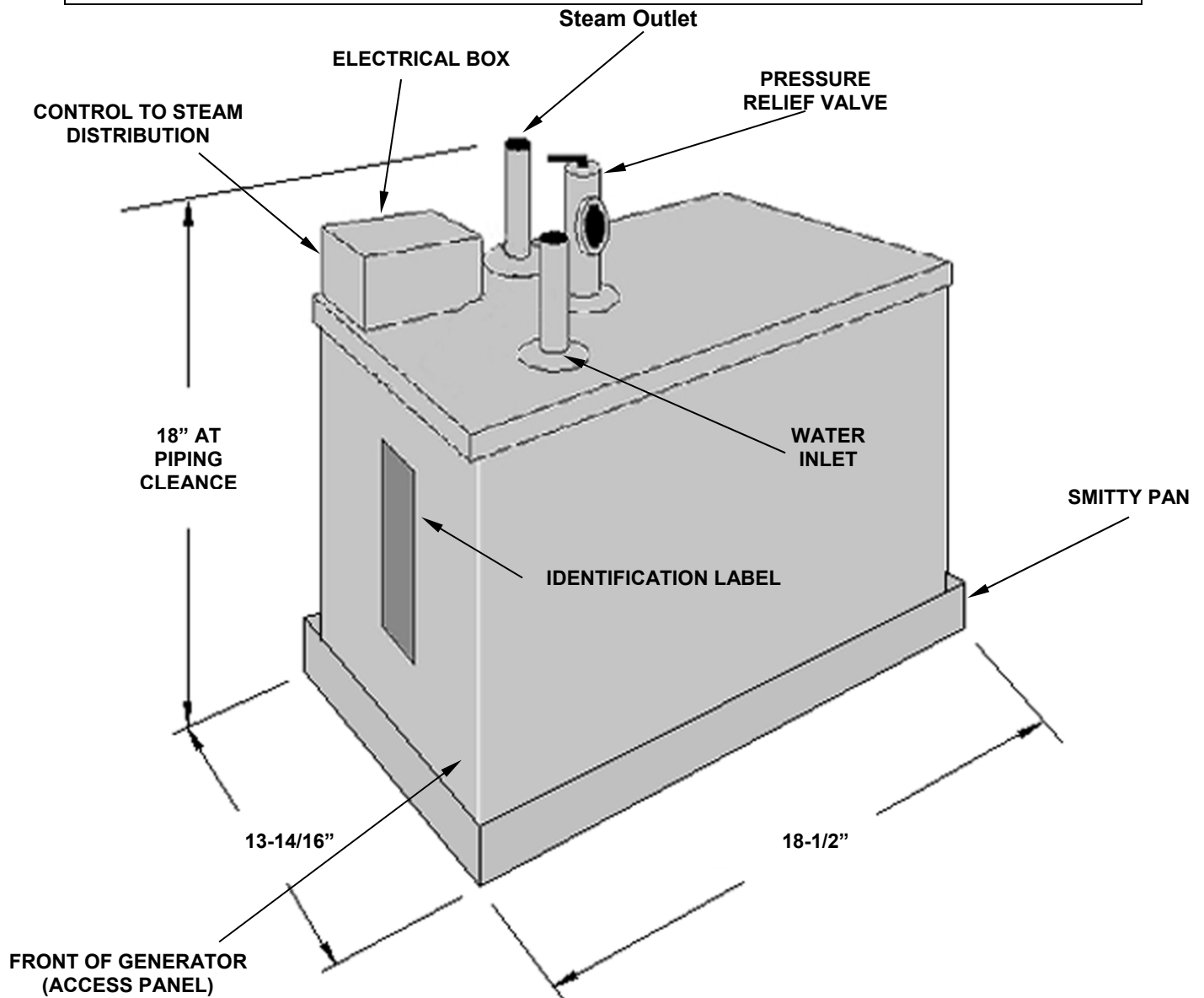

Figure 2

Note: The generator must be mounted level with all connections on top.

Generator Installation Instructions (con't)

Materials Needed

- Brass ball valve (for water supply shut off)
- Pipe compound
- Copper or brass fittings & nipples (sizes and quantities per instructions)
- In-line water filter (recommended)
- 3/8" brass or copper union
- 1/2" brass or copper union
- Wire (sizes and quantities per instructions)
- Copper tubing or pipe
- Wire cap nuts
- Flex conduit
- Silicone
- Other materials as required

Tools Needed

- Pipe wrench
- Tubing cutter
- Wire cutters or wire strippers
- Adjustable wrench
- Screwdrivers (Phillips & regular)
- Solder & Flux
- 1-1/16" masonry drill bit
- 7/8" hole saw for Deluxe Steam head
- Drill motor
- Propane torch
- Other tools as required

Note: ThermaSol steam bath generators are for indoor use only. They should never be located outside the home.

Note: ThermaSol steam bath generators are NOT designed to be used for space heating purposes.

Warning: Please consult your physician before using. If you are pregnant, elderly, have high blood pressure, diabetes, suffering from heart disease, intoxicated, or not in good health, do not use this steam bath.

UP TO FOUR ROOMS

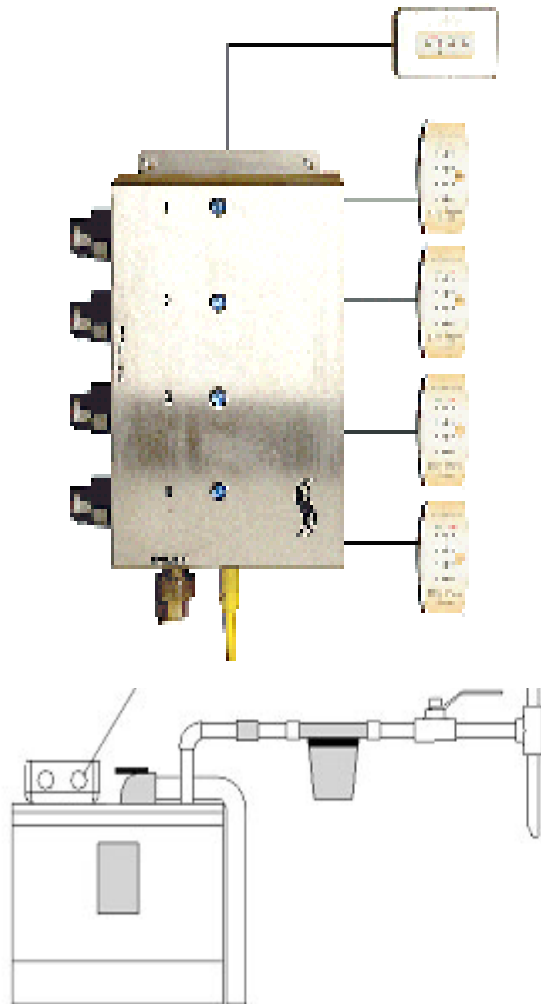

Figure 3

Note: The generator must be mounted level with all connections on top.

!!!! IMPORTANT !!!!

LOCATE THE STEAM HEAD 6" INCHES BELOW CEILING AND 6 INCHES FROM NON BENCHED/SEATED/DOOR INTERIOR WALL CORNER. STEAM HEAD IS TO BE MOUNTED AS FAR AS POSSIBLE FROM TYPICAL BATHING POSITION (SEATED OR STANDING) AND AS FAR FROM CONTROL AS POSSIBLE WHILE MAINTAINING APPROXIMATELY A - 60" CONTROL HEIGHT.

Electrical Installation

Note: All electrical wiring must be done per National/Local Electrical Codes.

**** ThermaSol requires that a licensed electrician perform all electrical work. ****

Note: USE COPPER WIRE ONLY.

Wire sizes recommended by NEC (2002 Version). Minimum wire temperature rating 90°C. Type THHN.

Generator Model	Phase	Wire Gauge	Breaker Size	Factory Sized Cu Ft MAX	AMP draw @ 240-VAC	KW
Day Spa 150	1	8	50A	150	46A	10KW
Day Spa 250	1	6	60A	250	56A	12KW
Day Spa 400	1	8/8	40/40A	400	37/37A	16KW
Day Spa 650	1	8/8	50/50A	650	46/46A	20KW

Electrical Questions? (800) 776-0711 for Technical Support

Warning: Each generator should be wired to their own separate breaker.

1. Turn off all electricity to the working area at the main breaker panel!
2. Connect 208/240VAC electrical lines to wires labeled 1 & 2 (for DS-150, DS-250) 1, 2, 3, 4, (for DS-400, DS-650) located in the electrical box on generator, (refer to Figure 4).

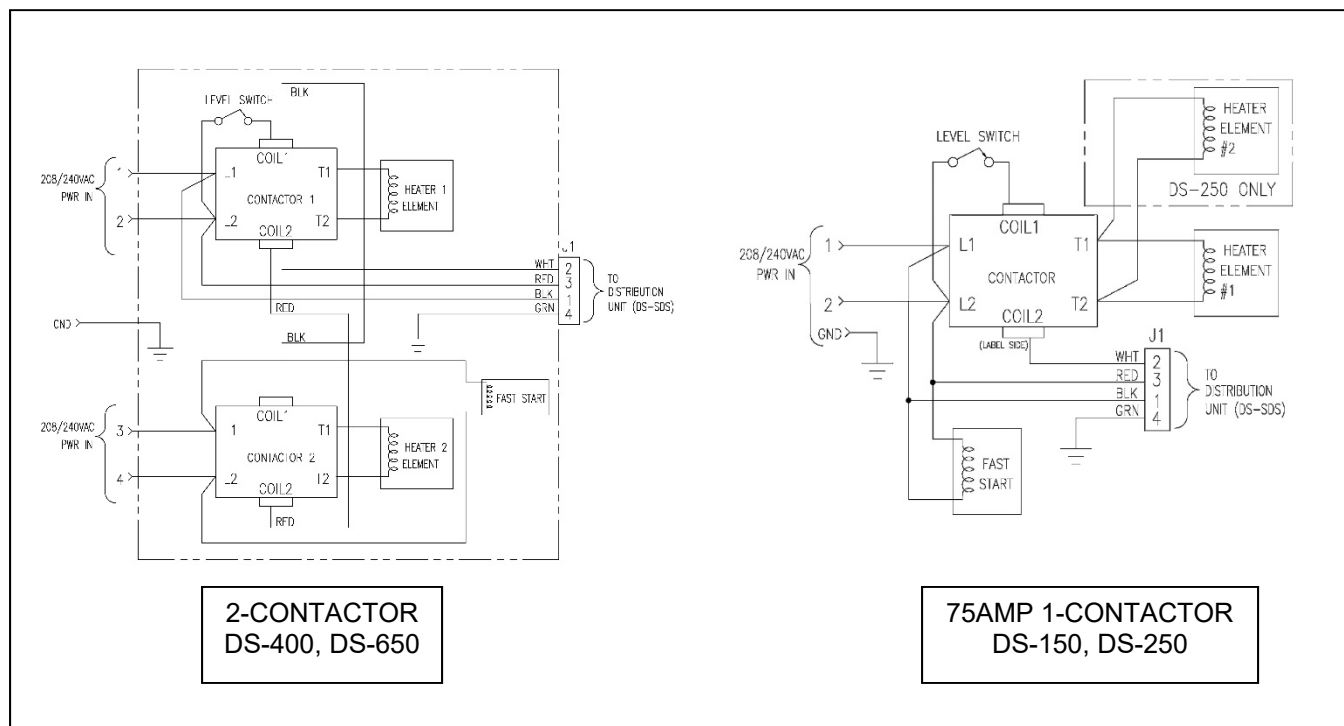

**Figure 4
Wiring diagram**

NOTE- the above wire diagram represents DS-250, DS-400, DS-650 models.

CONSUMER WARNING

WARNING

DO NOT USE THIS PRODUCT UNLESS YOU HAVE CONSULTED WITH YOUR DOCTOR AND RECEIVED WRITTEN PERMISSION TO DO SO. USE OF THIS PRODUCT MAY BE HAZARDOUS TO YOUR HEALTH.

WARNING

NEVER ATTEMPT TO FILL AROMA RESERVOIR ON THE STEAMHEAD WHEN UNIT IS IN THE ON POSITION. SEVERE BURNS WILL OCCUR.

WARNING

STEAM IS HOT! DO NOT TOUCH OR GO NEAR THE STEAMHEAD FROM THE TIME THE UNIT IS "ON", UP TO ONE HOUR AFTER IT HAS SHUT OFF. SEVERE BURN WILL OCCUR IF YOU COME IN CONTACT WITH THE STEAMHEAD OR STEAM EMITTING FROM THE STEAMHEAD.

WARNING

YOUR SHOWER MAY BE A SLIP AND FALL HAZARD CHECK WITH YOUR CONTRACTOR OR FLOORING MANUFACTURER REGARDING THE SAFE USE OF YOUR FLOORING IN A STEAM APPLICATION. SLIPPING AND FALLING INTO THE STEAMHEAD ITSELF OR INTO THE STREAM OF STEAM EMITTING FROM THE STEAMHEAD WILL CAUSE SERIOUS BURNS, OR PHYSICAL INJURY.

WARNING

IF YOU ARE FEELING UNCOMFORTABLE, DIZZY, FAINT, OR STARTING TO FALL ASLEEP IMMEDIATELY EXIT THE STEAM ROOM.

WARNING

DO NOT USE STEAM ROOM WHILE UNDER THE INFLUENCE OF ALCOHOL OR DRUGS, AS THIS CAN BE HAZARDOUS TO YOUR HEALTH.

WARNING

DO NOT USE THERMASOL AROMA THERAPY OILS OR SKIN CARE PRODUCTS OR ANY PRODUCT IN CONJUNCTION WITH YOUR THERMASOL UNIT WITHOUT CONSULTING WITH YOUR ALLERGIST OR DOCTOR BEFORE USE. THESE PRODUCTS MAY BE HAZARDOUS TO YOUR HEALTH.

WARNING

DO NOT USE STEAM ROOM IF YOU ARE UNDER THE AGE OF 16 UNLESS SUPERVISED BY AN ADULT.

Steam Distribution System - Requirements for Proper Installation

1. **Turn off all electricity to the working area at the main breaker panel!**
2. Ensure the steam rooms to be used are vapor proof. They should have a vapor proof door that seals well so the steam does not escape. Make sure the walls, ceiling and floor materials are suitable for use with steam and hot condensation, the steam produces.
3. Unit may be installed up to 50 feet away from steam rooms and 6 feet away from the steam generator in a dry well ventilated area.
4. Use copper or brass fittings only (**NEVER USE GALVANIZED FITTINGS**).
5. The steam inlet uses 3/4" NPT and the steam outlets use 1/2" NPT for easy installation.
6. The Steam Distribution System must be upright, accessible and on a vertical surface. Access panel and connections must be unobstructed and allow for easy access (**See Figure 5**).
7. Connect the steam inlet to the Generator steam outlet using 3/4 copper pipe. Keep this pipe running from low to high using the shortest way. Install proper steam rated insulation.
8. Connect the steam outlets to the pipes running to the steam room.
9. Connect the supplied 6 foot electrical cord from the DS-SDS to the generator making sure the pins align correctly. Do not apply excessive force; Connectors have only one way to connect.
10. The auxiliary connection on the DS-SDS should remain capped. In a case of two or more DS-SDS units, connect the next DS-SDS unit to the auxiliary output of the first.
11. Steam lines can run up, down, or horizontal; **but cannot run down and then up**. If it does, a steam trap will be produced at the low point blocking the flow of steam. **Do not** plumb a trap in the steam line. Insulate the steam outlet piping if the piping run exceeds 10 feet or is exposed to cold areas.
Note: Use steam rated insulation.
12. **Do not** plumb the pressure relief valve into the steam line. **Plumbing the pressure relief valve into the steam line can be hazardous, should the steam outlet be capped off or obstructed.**
13. Pitch / angle steam line towards steam heads and avoid perfectly level plumbed lines.
14. Make sure water is turned on before operating the unit.
15. The Generator has to be installed below the Steam Distribution unit.
16. Connect the room controls to the appropriate room number; Use the supplied 50-foot cables.
17. Connect the Sentinel Board (If Purchased) to the Sentinel input on the DS-SDS. (**See figure 5**)
18. Testing the system will be done when Steam Distribution System is connected to the Generator. **Do not attempt to operate the Steam Distribution unit without the Generator connected to it.**

Note: Failure to follow installation instructions specifically will cause the warranty to be void.

Steam Distribution System Installation Instructions

All ThermaSol Steam Distribution Systems are designed to build **NO PRESSURE** during operation. This is for your safety.

Note: Failure to follow installation instructions specifically will cause the warranty to be void.

Note: The DS-SDS must be mounted vertically with all connections on top.

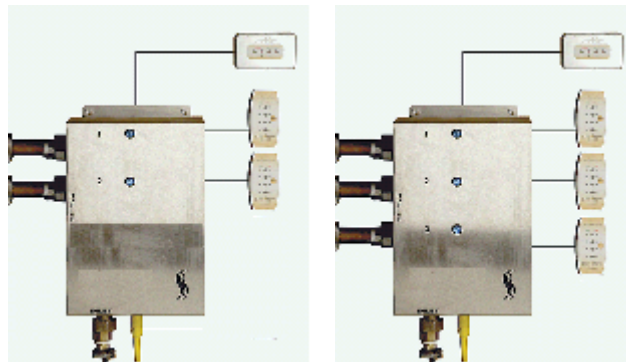
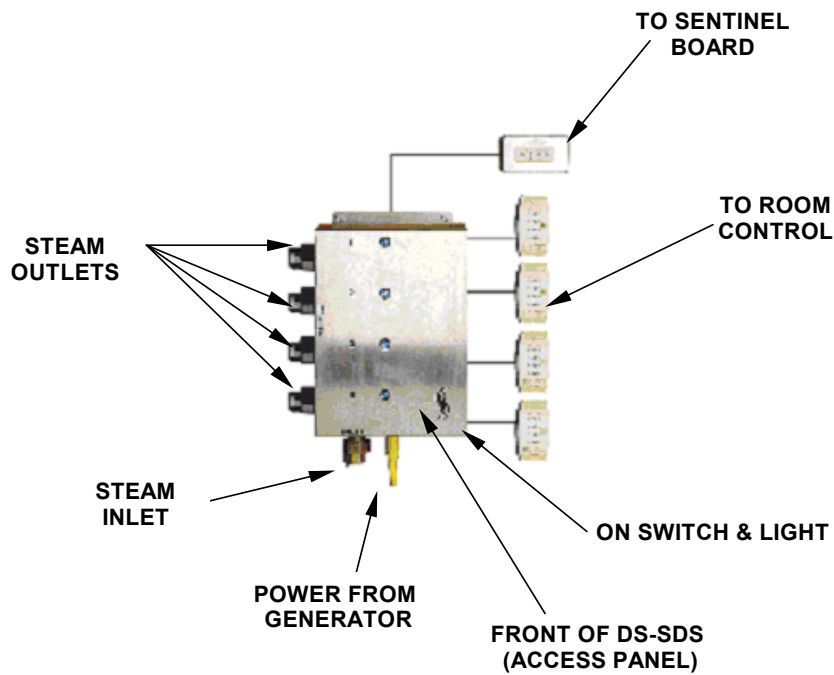

DS-SDS-2

DS-SDS-3

Figure 5

Steam Distribution System Installation Instructions (con't)

Materials Needed

- Pipe compound
- Copper or brass fittings & nipples (sizes and quantities per instructions)
- Wire (sizes and quantities per instructions)
- Copper tubing or pipe
- Wire cap nuts
- Silicone
- Other materials as required

Tools Needed

- Pipe wrench
- Tubing cutter
- Wire cutters or wire strippers
- Adjustable wrench
- Screwdrivers (phillips & regular)
- Solder & Flux
- 1-1/16" masonry drill bit
- Drill motor
- Propane torch
- Other tools as required

Note: ThermaSol steam bath systems are for indoor use only. They should never be located outside the home.

Note: ThermaSol steam bath systems are NOT designed to be used for space heating purposes.

Warning: Please consult your physician before using. If you are pregnant, elderly, have high blood pressure, diabetes, suffering from heart disease, intoxicated, or not in good health, do not use this steam bath.

STEAM HEAD INSTALLATION

Parts Enclosed

- Deluxe steam head
- Escutcheon

Tools Needed

- Pipe wrench
- 7/8" cutting tool
- Silicone gun
- Other tools as required



IMPORTANT NOTE!

Locate the steam head 6" from any corner, 12" from the floor, and as far away as possible from any bench, seat or door. The steam head is to be mounted as far away as possible from typical bathing positions (seated or standing) and as far away from the room temperature sensor as possible.

1. Drill a 7/8" diameter hole in the shower wall or wall above the bathtub for the steam outlet line.
2. Connect 1/2" copper pipe or copper tubing and 1/2" brass union onto the steam outlet. Run a 1/2" copper pipe from the union to the 7/8" hole in wall.
3. Attach the steam head and escutcheon to the copper pipe. **CAUTION: Do not obstruct the steam line with any shut-off valves, plugs or caps. All Steam Suite generators are designed to build NO PRESSURE. NOTE:** Make sure the steam head **ARROW** is pointing **UP** as shown in the detail below. Then press chrome cover over the steam head with the lettering **HOT** upright and readable.
4. The steam line can run up, down, or horizontal; but **cannot run down and then up**. If it does, a steam trap will be produced at the low point blocking the flow of steam. Insulate the steam outlet piping if the piping run exceeds 10 feet or is exposed to cold areas. **NOTE: Use steam rated insulation (225 °F minimum).**

WARNING: Avoid contact with steam head! It will burn you. Avoid direct contact with the steam coming out of the steam head! It is extremely hot! It will burn you!

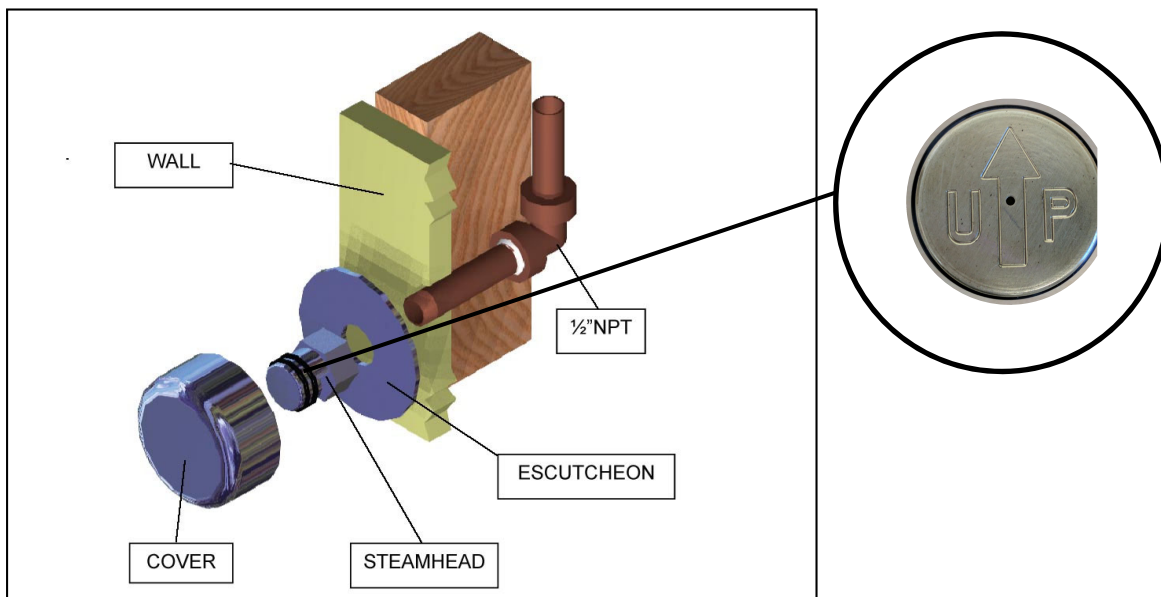

CONSUMER WARNING

WARNING

DO NOT USE THIS PRODUCT UNLESS YOU HAVE CONSULTED WITH YOUR DOCTOR AND RECEIVED WRITTEN PERMISSION TO DO SO. USE OF THIS PRODUCT MAY BE HAZARDOUS TO YOUR HEALTH.

WARNING

NEVER ATTEMPT TO FILL AROMA RESERVOIR ON THE STEAMHEAD WHEN UNIT IS IN THE ON POSITION. SEVERE BURNS WILL OCCUR.

WARNING

DO NOT USE THERMASOL AROMA THERAPY OILS OR SKIN CARE PRODUCTS OR ANY PRODUCT IN CONJUNCTION WITH YOUR THERMASOL UNIT WITHOUT CONSULTING WITH YOUR ALLERGIST OR DOCTOR BEFORE USE. THESE PRODUCTS MAY BE HAZARDOUS TO YOUR HEALTH.

WARNING

YOUR SHOWER MAY BE A SLIP AND FALL HAZARD CHECK WITH YOUR CONTRACTOR OR FLOORING MANUFACTURER REGARDING THE SAFE USE OF YOUR FLOORING IN A STEAM APPLICATION. SLIPPING AND FALLING INTO THE STEAMHEAD ITSELF OR INTO THE STREAM OF STEAM EMITTING FROM THE STEAMHEAD WILL CAUSE SERIOUS BURNS, OR PHYSICAL INJURY.

WARNING

STEAM IS HOT! DO NOT TOUCH OR GO NEAR THE STEAMHEAD FROM THE TIME THE UNIT IS "ON", UP TO ONE HOUR AFTER IT HAS SHUT OFF. SEVERE BURN WILL OCCUR IF YOU COME IN CONTACT WITH THE STEAMHEAD OR STEAM EMITTING FROM THE STEAMHEAD.

WARNING

DO NOT USE STEAM ROOM WHILE UNDER THE INFLUENCE OF ALCOHOL OR DRUGS, AS THIS CAN BE HAZARDOUS TO YOUR HEALTH.

WARNING

IF YOU ARE FEELING UNCOMFORTABLE, DIZZY, FAINT, OR STARTING TO FALL ASLEEP IMMEDIATELY EXIT THE STEAM ROOM.

WARNING

DO NOT USE STEAM ROOM IF YOU ARE UNDER THE AGE OF 16 UNLESS SUPERVISED BY AN ADULT.

Day Spa Control Installation Instructions

1. The Day Spa Time & Temp digital control must be located inside the shower area.
2. Install the touch pad 4 to 6 feet from the floor inside the steam room. Drill a 1-1/16" hole in the wall.
3. Bring the control cable from the Steam Distribution System (DS-SDS) through the 1-1/16" hole. Using the coupler, connect the cable to the touch pad connector. Ensure the coupler is located higher in the wall than the control. Do not pinch, nail, wedge or damage the control cable. Any damage to the control cable could result in the control not working properly. If the control is not installed immediately, protect the end connector with tape or some other kind of shielding material.
4. Connect the other end of the control cable to the Steam Distribution System (DS-SDS) **BEFORE** turning power on to the Generator and the Steam Distribution unit.
5. Turn on both water, power to the Generator and switch on the Steam Distribution unit.
6. Test the touch pad to ensure it is properly connected. If any problems arise, call **THERMASOL-Technical Support (800) 776-0711**.
7. **THESE STEPS MUST BE TAKEN OR YOUR WARRANTY WILL BE VOID**. Coat the entire control back with supplied waterproof silicon. Completely seal the control to the wall so moisture does not get behind it. Place the control on the wall pressing firmly. You may need to tape the control into place until the silicone dries. Be careful not to harm the wall and/or control with the tape. **(Figure 6)**

Note - Let newly installed control dry for 24 hours before using steam bath.

Failure to follow installation instructions specifically will cause the warranty to be void!

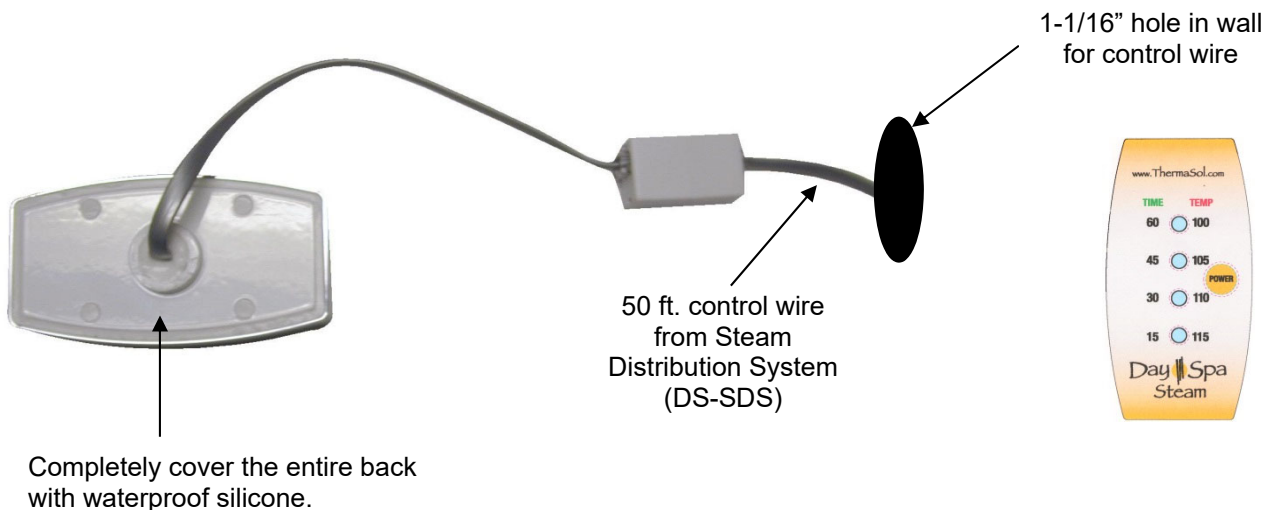

Figure 6

Day Spa Control Operating Instructions continued,

WARNING: Please consult your physician before using this steam bath if you are pregnant, elderly, have high blood pressure, diabetes, suffering from heart disease, intoxicated, or in poor health.

- 1. Starting Your Steam Bath.** Press the “Control Button” momentarily to activate your steam bath session. Your control will come from the factor with a default setting of 60 minutes at 100°F (to change these settings move to steps 2 and 3) once the button is pressed you will see a green LED appear indicating the time to be set, four seconds will pass and a red LED will appear indicating the temperature to be set. **(Figure 7)**

Note: Green LED's indicate the time and the red LED's indicate the temperature.

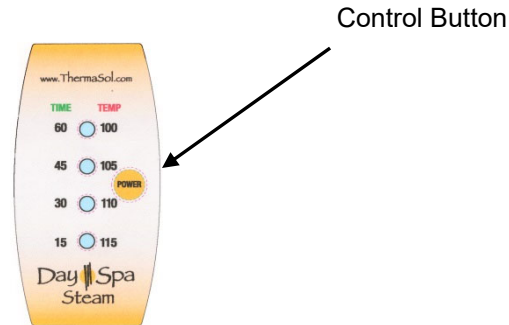

Figure 7

- 2. Changing Session Time.** While the green LED is still flashing (within 4 seconds), momentarily press the “Control Button”. Repeat until the green LED associated with your desired time starts flashing. Once the desired time is flashing, wait 4 seconds and that time will be accepted by the control. **(Figure 8)**

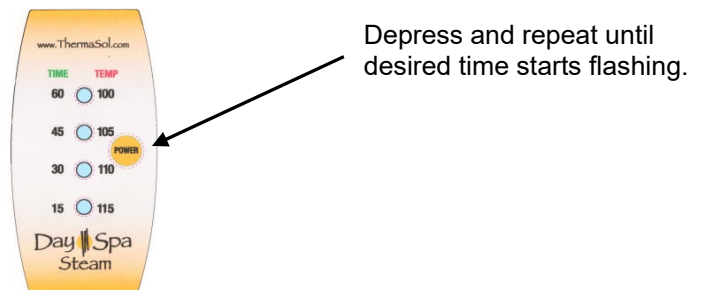

Figure 8

- 3. Changing Session Temperature.** After the time has been selected, the red 100° LED will automatically start flashing. If this is the desired temperature, wait 4 seconds and that temperature will be accepted by the control and the generator will start. If a different temperature is desired, momentarily press the “Control Button”. Repeat until the red LED associated with your desired temperature starts flashing. Once the desired temperature is flashing, wait 4 seconds and that temperature will be accepted by the control and the steam will start. **(Figure 9)**

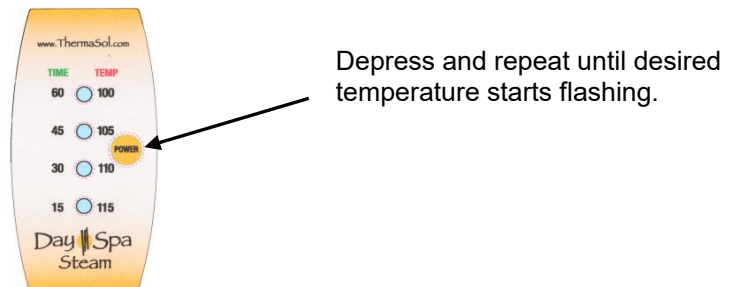

Figure 9

4. Manual Power Off. To manually power off the generator before the selected time has expired, press the “Control Button” once. The LED’s will go off and the steam will turn off. **(Figure 10)**

Note: The Day Spa TT control has a built in memory and will remember your time and temperature setting for the next session.

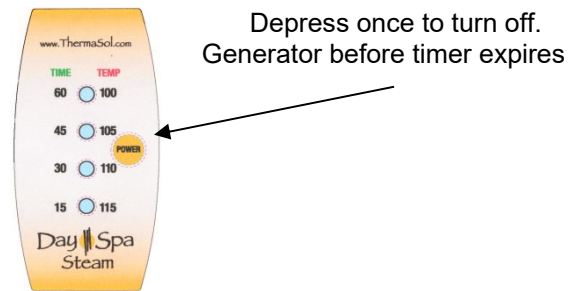

Figure 10

5. Diagnostic Feature. The Day Spa TT control has a unique diagnostic feature. If there is a malfunction within the unit, it will alert you. The red 105° LED will flash if the shower area exceeds 135°F, and the red 115°F LED will flash if the control button becomes stuck. If any of these diagnostics happen the unit will shut down and lock out all user interfaces. To reset the unit, power will need to be reset at the breaker or at the steam distribution system switch. Contact a ThermaSol technician at **(800) 776-0711** for further trouble shooting steps. **(Figure 11)**

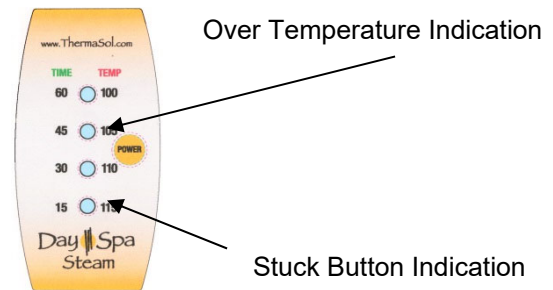

Figure 11

(Optional) Day Spa Sentinel Installation Instructions

1. The Day Spa Sentinel (**Figure 13**) can be located anywhere within 100 ft of the Steam Distribution System (DS-SDS).
2. Install the Sentinel display 2 to 6 feet from the floor on a wall. Drill a 1-1/16" hole in the wall.
3. Bring the control cable from the Steam Distribution System (DS-SDS) through the 1-1/16" hole. Using the coupler, connect the cable to the Sentinel connector. Ensure the coupler is located higher in the wall than the Sentinel. Do not pinch, nail, wedge or damage the control cable. Any damage to the control cable could result in Sentinel not working properly. If the Sentinel is not installed immediately, protect the end connector with tape or some other kind of shielding material.
4. Ensure the Steam Distribution System (DS-SDS) is powered-down (off). Connect the other end of the control cable to the Steam Distribution System (DS-SDS) at the Sentinel connection port (**Figure 12**).

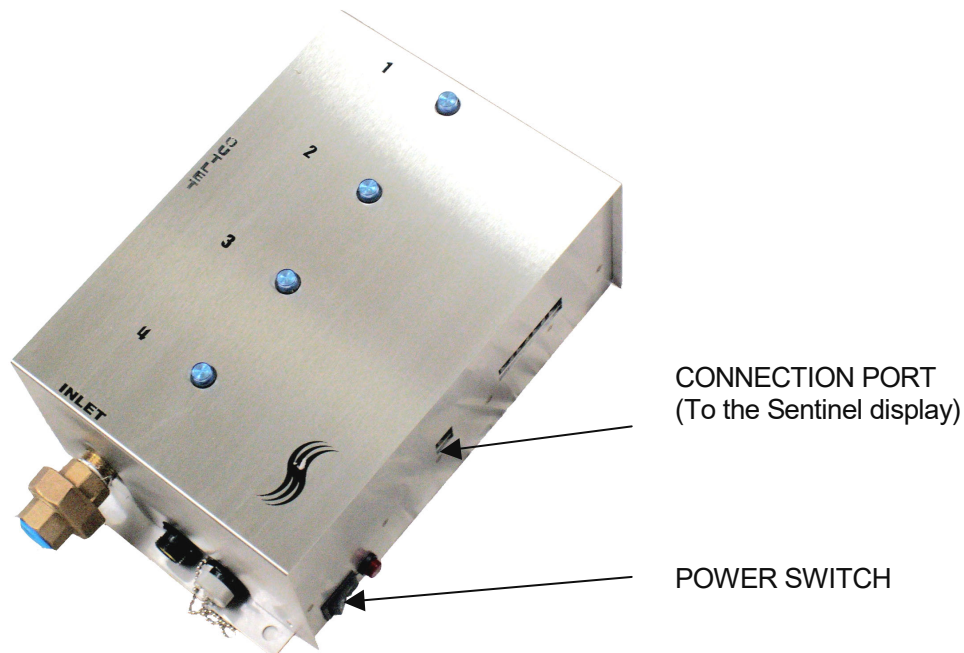

Figure 12: Steam Distribution System

5. Turn on both water and power to the generator and switch on the Steam Distribution System (DS-SDS).

Day Spa Sentinel Installation Instructions continued,

6. **THE FOLLOWING STEPS MUST BE TAKEN OR YOUR WARRANTY WILL BE VOID.** Coat the entire sentinel back with supplied waterproof silicon. Completely seal the sentinel to the wall to create a moisture barrier. Place the sentinel on the wall pressing firmly. You may need to tape the sentinel into place until the silicone dries. Be careful not to harm the wall and / or sentinel with the tape
(Figure 13). Let dry for 24 hours before using.

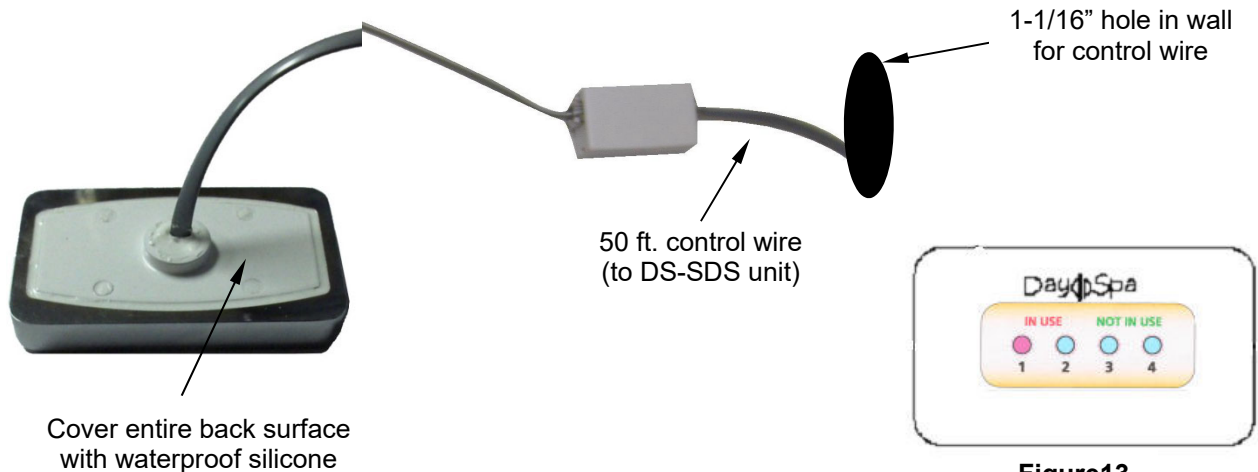

Figure13

Day Spa Sentinel Operating Instructions

Notes:

- The Day Spa Sentinel is an optional monitoring device. It does not control or change the status of room availability or steam. The Day Spa functionality will not change with a system setup that includes the Sentinel feature.
 - A special power save feature will make all four lights be dim green, when all four rooms are available. This is useful when the Day Spa system is in standby operation or operates at after hour's mode.
 - In the case of a Day Spa that includes fewer than four rooms, e.g. 2 room setup, the unconnected rooms will be indicated as green lights (available rooms) even though the Day Spa does not actually have them connected.
1. **Functionality:** The Day Spa Sentinel purpose is to monitor the activity use of the steam room connected to the Steam Distribution System. A single Day Spa Sentinel is capable of showing whether any of the four rooms connected to the Steam Distribution System is occupied or not.
 2. **Room Availability:** Available room will be indicated by a green light corresponding to the appropriate steam room number. Occupied (in use) steam room will be indicated by a red light. **(figure 14)**

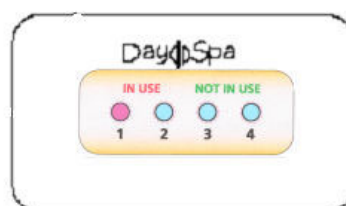

Figure 14

PAGE 21 CONTAINS IMPORTANT WARRANTY RETURN INSTRUCTIONS

Please complete the **DAY SPA WARRANTY REGISTRATION CARD** information on the following page. Please ensure to include all information requested on the card.

After completing the required information, cut along the dotted lines and place in stamped envelope and address to:

ThermaSol Steambath Company
Headquarters & Technical Support
1958 Steam Way, Round Rock, TX 78665 – (800) 776-0711

For any questions regarding your DAY SPA Warranty
Contact: ThermaSol - Technical Support at (800) 776-0711
Mon – Fri 7:00 – 7:00 CST

NOTES:



Cleanse Your Body. Purify Your Soul.

DAY SPA 5 YEAR "NO QUESTIONS ASKED" – FACTORY WARRANTY

ThermaSol will repair the specific failure on your ThermaSol DAY SPA Series Steam generator manufactured after February 1, 2006 at its factory for 5 years. All expenses required to remove and send the unit to the factory, return and reinstall the unit is the responsibility of the owner.

EXCLUSION

- I. This service warranty does not cover: parts or product damaged in shipment; manufacturing defects observable prior to installation; parts or product damaged during installation; malfunction of equipment due to improper installation or installation not according to manufacturer specifications and/or installation instructions; use of cleaning solution not supplied by, or specifically approved by ThermaSol (Please refer to ThermaSol operating instruction manual for further information); parts or product installed in a manner that does not permit proper access to service; damages to plated parts and accessories due to chemical corrosion or reaction; cosmetic damage; normal periodic cleaning and care or damage caused by not following manufacturer's cleaning instructions; repairs caused by accident; neglect, misuse, vandalism, fire, lightning, earthquake, or any other peril; unauthorized and/or improper modification or damage to structure. Any repair or installation modification that is subject to the above exclusion shall be paid by the Customer at the current labor and material charges in effect at the time.
- II. ThermaSol will exercise reasonable efforts in rendering service under this warranty, but shall not be liable for any damage arising out of delays. This warranty only covers the repair and/or replacement as specified by the warranty.
- III. This warranty gives you specific legal rights and you may also have other rights which may vary from state to state. Determination of rights under this warranty is in accordance with the laws in the state of Texas. Any dispute under the warranty must be submitted and resolved by arbitration in Texas.
- IV. ThermaSol does not guarantee that a local service person will be available. Unit may have to be removed and reinstalled at owner's expense. It is the responsibility of the buyer to file a claim with the carrier/carriers for any product that has shipping damage to or from ThermaSol. An EVA (Evaluation Number) must be obtained from the factory and used on any correspondence or packages sent to the factory. ThermaSol, 1958 Steam Way, Round Rock, TX 78665 – Phone: (800) 776-0711

TERMINATION

This warranty will be terminated by ThermaSol for the following reasons: Improper installation or use; service to equipment by unauthorized personnel; installation that does not permit proper access for service; non-payment of repairs not covered under warranty; **non-remittance of completed warranty card**. Modification to unit not authorized by ThermaSol; use of non-ThermaSol repair parts.

DAY SPA WARRANTY REGISTRATION CARD / COMMERCIAL UNIT

NAME OF FACILITY: _____ PHONE: () _____

ADDRESS: _____ CITY: _____ STATE: _____ ZIP: _____

EMAIL: _____

I first heard about ThermaSol (please check one):

- in a magazine/newspaper ad
- at a consumer trade show
- at the dealer or outlet where I purchased generator
- Website
- Other _____

SERIAL NO.: _____ MODEL: _____

DATE OF PURCHASE: _____ DEALER/OUTLET: _____

INSTALLER NAME: _____ PHONE: () _____

INSTALLER ADDRESS: _____ CITY: _____ STATE: _____ ZIP: _____

CUSTOMER SIGNATURE: _____ DATE INSTALLED: _____

The Steam generator is working: Satisfactory Unsatisfactory Comments: _____