

HMCB36WS

36-INCH CHIMNEY WALL HOOD WITH BLOWER

MASTERPIECE® SERIES



FEATURES & BENEFITS

- Masterpiece® Chimney Wall hoods are sleek, slim, and distinctive in design that add a sophisticated touch to contemporary kitchens
- ★ - Noise Control Technology™ reduces noise while hood is in use
- ★ - Equipped with the Thermador Connected Experience by Home Connect™
 - Cooktop Hood Sync enables control through Freedom® Induction Cooktop
 - Beautiful illumination with multi-level, vivid LED lights

ACCESSORIES (OPTIONAL)

Stainless Steel Chimney Hood Extension

CHXTHMCB - For up to 12-foot ceiling applications. Extension replaces upper section of standard chimney extension.

Recirculation Kit

RECHMCB - For HMCBxxWS Masterpiece® Chimney Wall Hoods only

Replacement Charcoal Filter

CHFHMCD - For use with recirculation kit RECHMCB

Remote Control Panel

REMCPU - Ability to vertically install on cabinetry or wall to control hood in a convenient location



GENERAL PROPERTIES

Features

Cooktop Hood-Sync Enabled, Noise Control Technology™, Multi-Level LED Lights with Fading Transitions, Automatic Mode, Check Filter Reminder Light, Delay Shut-Off

Operating Mode	Convertible: Ducted / Recirculating
Maximum CFM (Blower)	600 CFM
CFM (HVI)	490 HS / 170 WS
Sones (HVI)	10.5 HS / 2 WS
Number of Speed Settings	4-Stage
Motor Location	Integrated Motor In Hood Body
Number of Lights	2
Bulb Type	LED
Light Lumens	100 – 150
Light Color	3500 – 4000 °K
Total Power of the Lamps	2.4 W
Damper Included	Yes
Grease Filter Material	Washable Stainless Steel
Grease Filter Type	Hybrid Mesh
Home Connect™ (Wi-Fi Enabled)	Yes

TECHNICAL DETAILS

Watts	447 W
Current	15 A
Volts	120 V
Frequency	60 Hz
Plug Type	Fixed Connection

DIMENSIONS & WEIGHT

Overall Appliance Dimensions (Width of Canopy Included) (HxWxD)	5" x 35 15/16" x 23 3/16"
Height of the Chimney	25" – 27"
Accommodates Ceiling Heights	Up to 9' Ceiling Heights
Minimum Distance Above Gas / Electric Cooking Surface	30" / 30"
Diameter of Air Duct Top	8"
Net Weight	69 lbs

WARRANTY

Limited Warranty Parts and Labor	2 Year
----------------------------------	--------

HS=High Speed; WS=Working Speed

HM CB36WS

36-INCH CHIMNEY WALL HOOD WITH BLOWER

MASTERPIECE® SERIES



HOOD DIMENSIONS

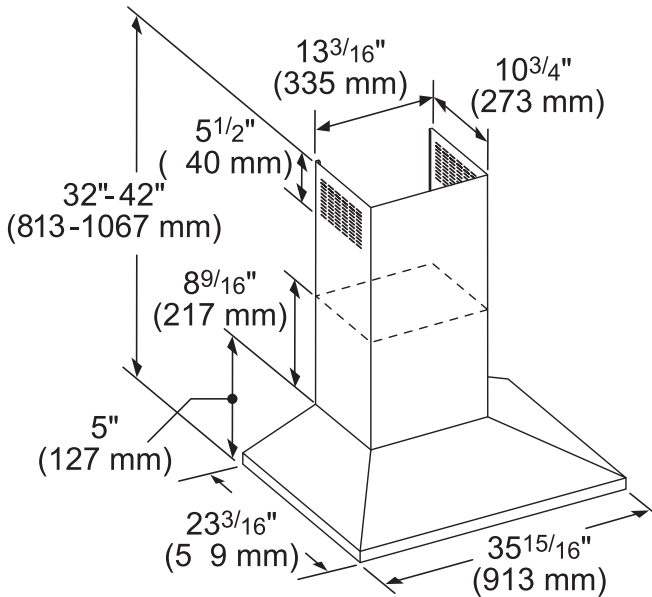

measurements in inches (mm)

OPTIONAL ACCESSORIES

CHIMNEY EXTENSION KIT CHXTHMCB

Telescoping design for extension up to 12' ceiling heights

RECIRCULATION KIT RECHMCB

Ideal for applications where ducting out is not possible

REPLACEMENT CHARCOAL FILTERS CHFHMCD

For Use With Recirculation Kit RECHMCB

REMOTE CONTROL PANEL REMCPW



Convenience at your fingertips: The remote control accessory offers the freedom to extend your hood controls to a more reachable spot

These warranties give you specific legal rights and you may have other rights that vary from state to state. Limited warranty from date of purchase. For complete warranty details, refer to your Use & Care manual, or ask your dealer.

Specifications are for planning purposes only. Refer to installation instructions and consult your countertop supplier prior to making counter opening. Consult with a heating and ventilation engineer for your specific ventilation requirements. For the most detailed information, refer to installation instructions accompanying product or write to Thermador indicating the model number. Specifications are correct at time of printing. Thermador reserves the right to change product specifications or design without notice. Some models are certified for use in Canada. Thermador is not responsible for products that are transported from the U.S. for use in Canada.