

INSTALLATION INSTRUCTIONS

Item#77301-XX-L (New. 2024/06/18)

READ AND SAVE THESE INSTRUCTIONS

WARNING! SHUT POWER OFF AT FUSE OR CIRCUIT BREAKER.

AVERTISSEMENT! COUPER LE COURANT AU NIVEAU DES FUSIBLES OU DU DISJONCTEUR.

MOUNTING THE FIXTURE (Fig.1)

1. Shut off power at the fuse box or circuit breaker. If necessary, remove the old fixture including the mounting hardware.
2. Carefully remove the fixture from the carton and check that all parts are included as show in Figure 1.
3. Unscrew screws (C) and rubber washers (E). Separate mounting plate (A) from fixture (D).
4. Position mounting plate (A) on the wall and mark the location of two drywall anchors (F). Pre-drill the holes for drywall anchors (F). Insert drywall anchors (F) into wall.
5. Attach mounting plate (A) to the junction box (Not included) with mounting screws (B) (size: 8-32*1/2"L). The side of the mounting plate (A) marked "GND" must face out.
6. Place woodscrews (G) through holes into drywall anchor (F) to secure mounting plate (A) as shown in (Fig.1).

Fig. 1

Set#A-021-122528
-Mounting Screw*2
-Ground Screw
-Mounting Plate

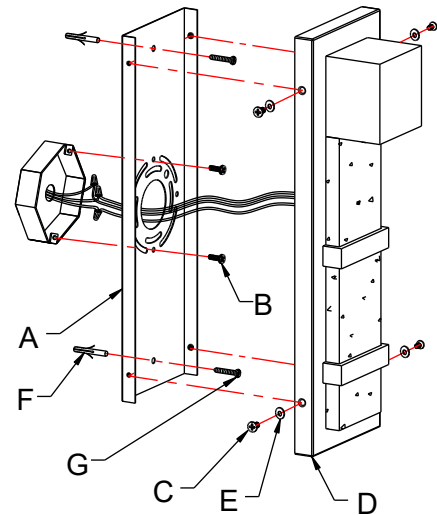

CONNECTING THE WIRES (Fig. 2)

7. Connect the electrical wires as shown in Fig. 2, making sure that all wire connectors are secured. If your junction box has a ground wire (green or bare copper), connect the fixture's ground wire to it. Otherwise, connect fixture's ground wire directly to mounting plate (A) using green screw provided.
8. After the wires are connected, tuck them carefully inside the junction box.

Fig. 2

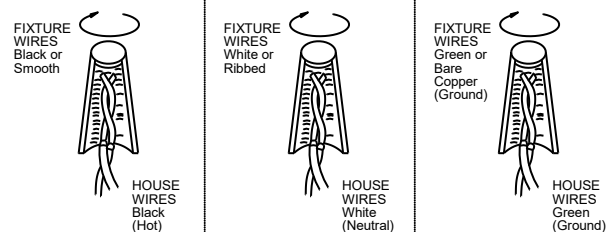

FINISHING THE INSTALLATION (Fig.1)

9. Align fixture (D) onto mounting plate (A) and secure with screws (C) and rubber washers (E) provided.
10. To prevent moisture from entering the junction box and causing a short circuit, use clear caulking (i.e. Indoor/Outdoor silicone sealant) to outline the outside of fixture (D) where it meets the wall leaving a space at bottom to allow moisture a means to escape (Fig.3).

Fig. 3

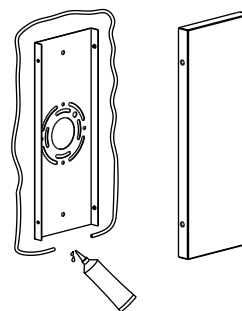

Your installation is now complete. Return power to the junction box and test the fixture.

Dimmable with ELV and/or LED compatible wall dimmer switches.

LA-3776E

