



T&S BRASS AND BRONZE WORKS, INC.

2 Saddleback Cove / P.O. Box 1088
Travelers Rest, SC 29690

Model No.

B-2365

Item No.

Travelers Rest, SC: 800-476-4103 • Simi Valley, CA: 800-423-0150 • Fax: 864-834-3518 • www.tsbrass.com

This Space for Architect/Engineer Approval

Job Name _____ Date _____

Model Specified _____ Quantity _____

Customer/Wholesaler _____

Contractor _____

Architect/Engineer _____

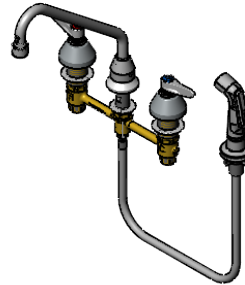
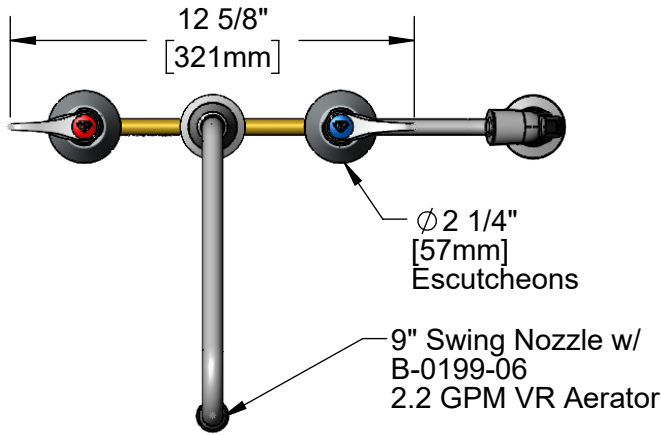

ADA Compliant

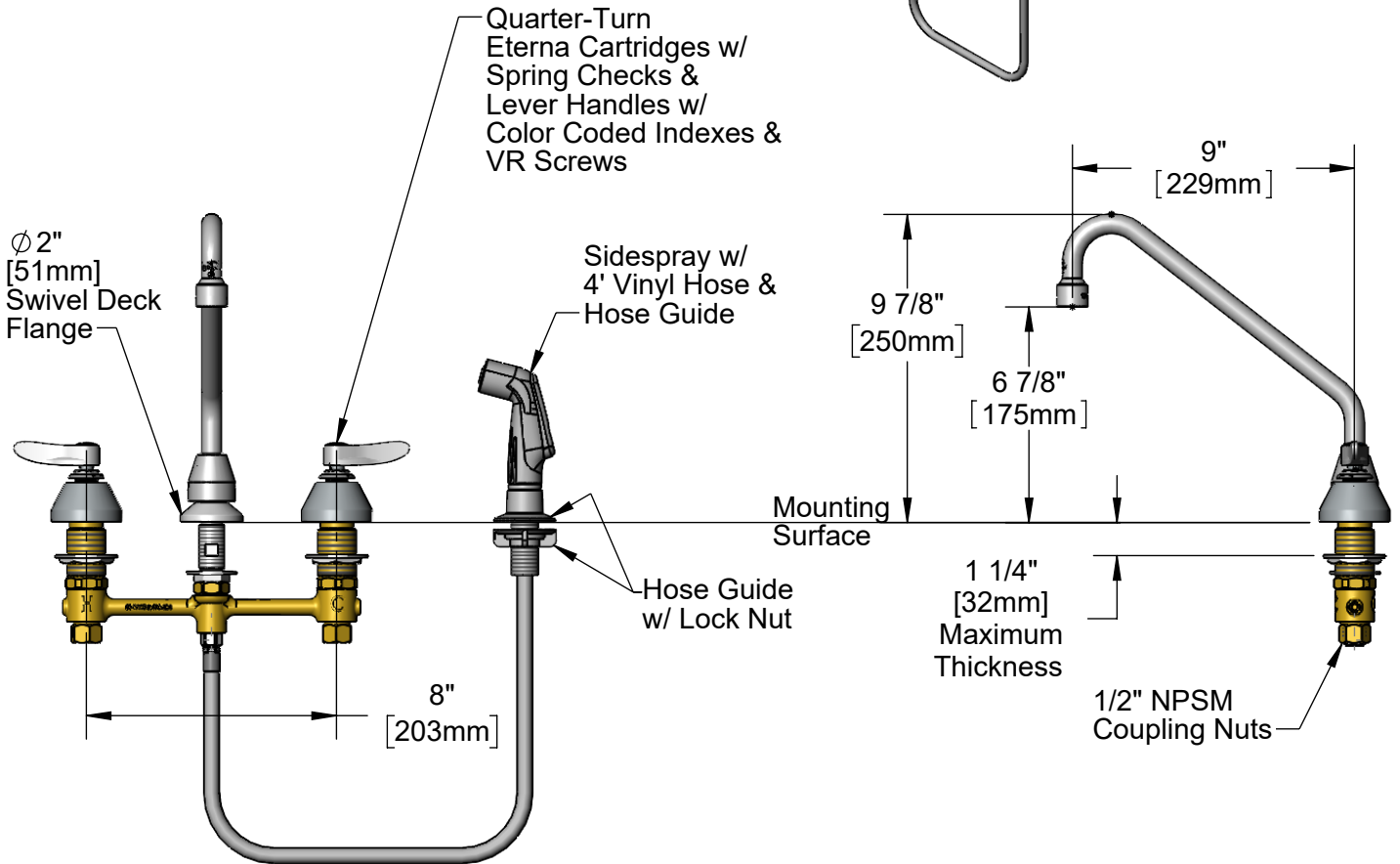

Rough-In Requirement:

- Ø 1" [25mm] for Center Shank and Sidespray
- Ø 1 1/2" [38mm] for Hot/Cold Side

Product Specifications:

8" Concealed Widespread EasyInstall Mixing Faucet w/ 4' Sidespray, Lever Handles, VR Screws, Quarter-Turn Eterna Cartridges w/ Spring Checks, 9" Swing Nozzle w/ 2.2 GPM VR Aerator and 1/2" NPSM Male Inlets w/ Coupling Nuts

Product Compliance:

ASME A112.18.1 / CSA B125.1
NSF 61 - Section 9
NSF 372 (Low Lead Content)
ANSI A117.1 (ADA)



T&S BRASS AND BRONZE WORKS, INC.

2 Saddleback Cove / P.O. Box 1088
Travelers Rest, SC 29690

Model No.

B-2365

Item No.

Travelers Rest, SC: 800-476-4103 • Simi Valley, CA: 800-423-0150 • Fax: 864-834-3518 • www.tsbrass.com

ITEM NO.	SALES NO.	DESCRIPTION
1	B-0199-06	VR 2.2 GPM Aerator, 55/64-27 Female
2	017208-40NS	Center Body Diverter Assembly (New Style)
3	002338-45	Valve Diverter Piston
4	018506-19NS	Blue Button Index, Press-in
5	VRS-2	VR Wrist Action Handle Screw (2) w/ Spanner Bit
6	016742-45	Center Flange Nut
7	016745-45	Compression Nut & Fitting
8	016752-40NS	EasyInstall, CWS Quarter-Turn Eterna Cartridge w/ Spring Check, LTC
9	016749-45	Sidebody C-Washer
10	016777-45	CWS Hanger
11	001495-45NS	4' Side Spray w/ Hose Guide, New Style
12	000958-20	Coupling Nut
13	016753-40NS	EasyInstall, CWS Quarter-Turn Eterna Cartridge w/ Spring Check, RTC
14	016743-25	CWS Eterna Bonnet
15	009002-40NS	Packing Assembly (New Style)
16	001257-40NS	Bell Escutcheon
17	001638-45NS	Lever Handle (New Style)
18	001193-19NS	Red Button Index, Press-in

015425-45
Vandal Resistant Key

017245-40
Installation Repair Kit
Includes #6, (2)#9, & #10

014075-45
#10 Spanner Bit

Product Specifications:
8" Concealed Widespread EasyInstall Mixing Faucet w/ 4' Sidespray, Lever Handles, VR Screws, Quarter-Turn Eterna Cartridges w/ Spring Checks, 9" Swing Nozzle w/ 2.2 GPM VR Aerator and 1/2" NPSM Male Inlets w/ Coupling Nuts

Product Compliance:
ASME A112.18.1 / CSA B125.1
NSF 61 - Section 9
NSF 372 (Low Lead Content)
ANSI A117.1 (ADA)