



Workboard / Bar Sink Faucets

B-1172-07-133X

TAG:

Workboard Mixing Faucet

Architect/Engineering Specifications:

8" deck mount mixing faucet with chrome plated brass body, 5 3/4" swivel gooseneck with 2.2 GPM aerator, compression cartridges with spring checks, lever handles, 1/2" NPT male inlets, polished chrome plated escutcheon, sidespray with 7 ft. vinyl hose and hose guide. Certified to ASME A112.18.1/CSA B125.1, NSF 61-Section 9 and NSF 372. Meets ADA ANSI/ICC A117.1 requirements.

Job Name _____
 Model Specified _____ Quantity _____
 Variations Specified _____
 Date _____

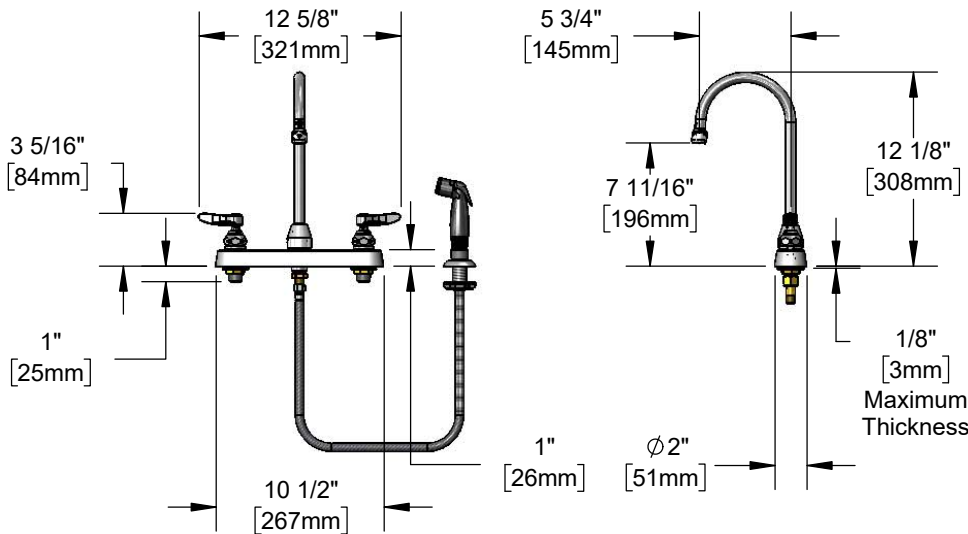

Features & Benefits:

- 8" deck mount mixing faucet w/ chrome plated brass body
- 5 3/4" swivel gooseneck
- 2.2 GPM aerator, Series 2 (B-0199-02)
- Quarter-turn Eterna compression cartridges with spring checks to prevent cross flow of water
- Lever handles w/ color coded indexes
- 1/2" NPT male inlets
- Tailpieces and nuts for 1/4" NPT male connections
- Polished chrome plated escutcheon
- Sidespray with 7 ft. vinyl hose and hose guide
- Material: Chrome plated brass body, tubular spout, thermoplastic sidespray body, vinyl hose and chrome plated metal handles & escutcheon

Product Compliance:

- ASME A112.18.1 / CSA B125.1
- NSF 61 - Section 9
- NSF 372 (Low Lead Content)
- ANSI A117.1 (ADA)



Warranty: One Year (Limited)

Performance Data:

- Pressure: 20 - 125 psi
- Temperature: 40 °F - 140 °F
- Flow Rate:
 Nozzle: 2.2 GPM @ 60 psi
 Sidespray: 2.2 GPM @ 60 psi



ADA Compliant

Optional Outlets (Series 2 / VR Series 7)

GPM	Aerated	Non-Aerated (Laminar)	VR Aerated	VR Non-Aerated (VR Laminar)
0.35	N/A	<input type="checkbox"/> B-0199-02-N035	N/A	<input type="checkbox"/> B-0199-07-N035
0.5	N/A	<input type="checkbox"/> B-0199-02-N05	N/A	<input type="checkbox"/> B-0199-07-N05
1.0	<input type="checkbox"/> B-0199-02-F10	N/A	<input type="checkbox"/> B-0199-07-F10	N/A
1.5	<input type="checkbox"/> B-0199-02-WS	N/A	<input type="checkbox"/> B-0199-07-WS	N/A
2.2	Standard	N/A	<input type="checkbox"/> B-0199-07	N/A

Optional Handles

- 4" Wrist Action
- Lever (Standard)

Optional Cartridges With Checks

- Quarter-Turn Cerama w/ Check Valve
- Quarter-Turn Eterna w/ Spring Check (Standard)



T&S BRASS AND BRONZE WORKS, INC.



• 2 Saddleback Cove • Travelers Rest, SC 29690
 Ph 800-476-4103 • Fax 864-834-3518
 • Simi Valley, CA • Ph 800-423-0150 • www.tsbrass.com

Date: 11/08/17