



SYMMONS® Elm®

Location:



553TB-18

18 inch Towel Bar

Specification Submittal

Model Numbers

553TB-18 18 inch Towel Bar

Options/ Modifications

- SBZ** **Seasoned Bronze**
- STN** **Satin Nickel finish**
- MB** **Matte Black finish**
- BBZ** **Brushed Bronze finish**

Note: Append appropriate -suffix to model number.

Feature Highlights

- Metal construction
- Standard finish is polished chrome

Warranty

Limited Lifetime - to the original end purchaser in consumer/residential installations.

10 Years - for commercial/industrial installations. Refer to www.symmons.com/warranty for complete warranty information.



Architectural/ Engineering Specification

Symmons Elm 18 inch Towel Bar _____ Includes Metal construction, Standard finish is polished chrome. 10 Year Commercial Warranty. Available options: "SBZ - Seasoned Bronze", "STN - Satin Nickel finish", "MB - Matte Black finish", "BBZ - Brushed Bronze finish".

Dimensions

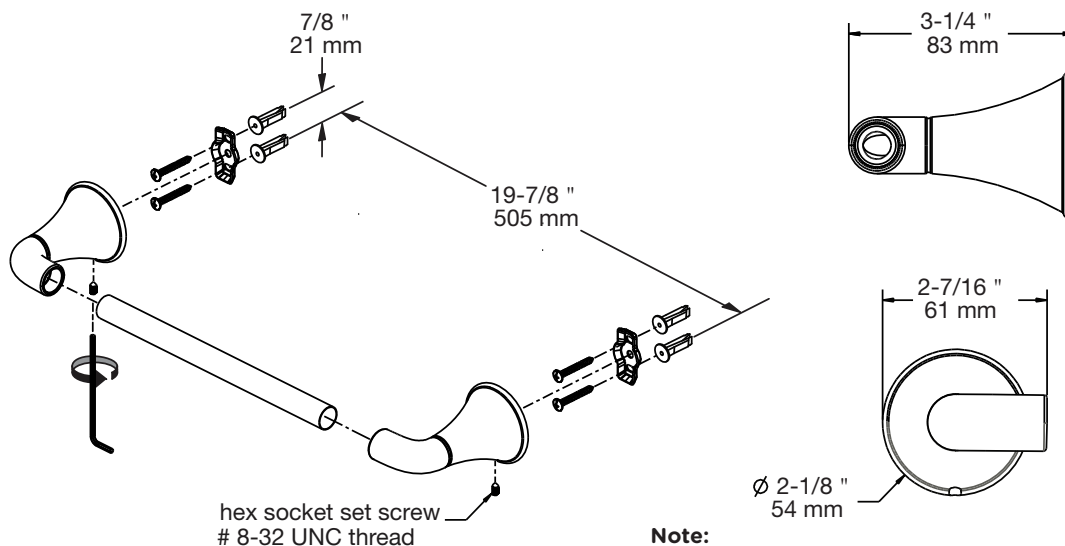

Note:
1) Dimensions subject to change without notice.