









Location:

Identity™



S-6701 Shower System Specification Submittal

Model Numbers	Specification
<input type="checkbox"/> S-6701 <i>Identity Shower System</i>	Shower system powered by the Temptrol® pressure-balancing valve. Features adjustable stop screw to limit handle turn, integrated volume control, 1 mode showerhead with easy to clean rubber nozzles and standard 2.5 gpm (9.5 L/min) flow restrictor. Components made from metal and nonmetallic materials, plated in standard polished chrome finish. <div style="text-align: right;">   </div>
Modifications <ul style="list-style-type: none"> <input type="checkbox"/> -1.5  1.5 gpm (5.7 L/min) flow restrictor <input type="checkbox"/> -2.0  2.0 gpm (7.6 L/min) flow restrictor <input type="checkbox"/> -143 3 mode showerhead <input type="checkbox"/> -145 5 mode showerhead <input type="checkbox"/> -231 2 mode showerhead <input type="checkbox"/> -CHKS Integral check stops - for use in installations where a positive shut-off device is used downstream of mixing valve <input type="checkbox"/> -IPS 1/2" female IPS connections <input type="checkbox"/> -L/HD Less showerhead <input type="checkbox"/> -LP Loop handle <input type="checkbox"/> -LR Lever handle <input type="checkbox"/> -OP 13" oval plate <input type="checkbox"/> -REB-TRM Rebuild trim kit <input type="checkbox"/> -REV Reverse coring, hot on right, cold on left, for back to back installations <input type="checkbox"/> -STN Satin Nickel finish <input type="checkbox"/> -TRM Trim only, valve not included <input type="checkbox"/> -X Integral service stops - allows water shutoff at valve for service 	
Compliance	
<ul style="list-style-type: none"> -ASME A112.18.1/CSA B125.1 -WaterSense 1.5 gpm (5.7 L/min) 2.0 gpm (7.6 L/min) <div style="text-align: right;">   </div>	
Warranty	
<p>Limited Lifetime - to the original end purchaser in consumer/residential installations.</p> <p>5 Years - for industrial/commercial installations.</p> <p>Refer to www.symmons.com/warranty for complete warranty information.</p>	

Note: Append appropriate -suffix to model number.

Dimensions

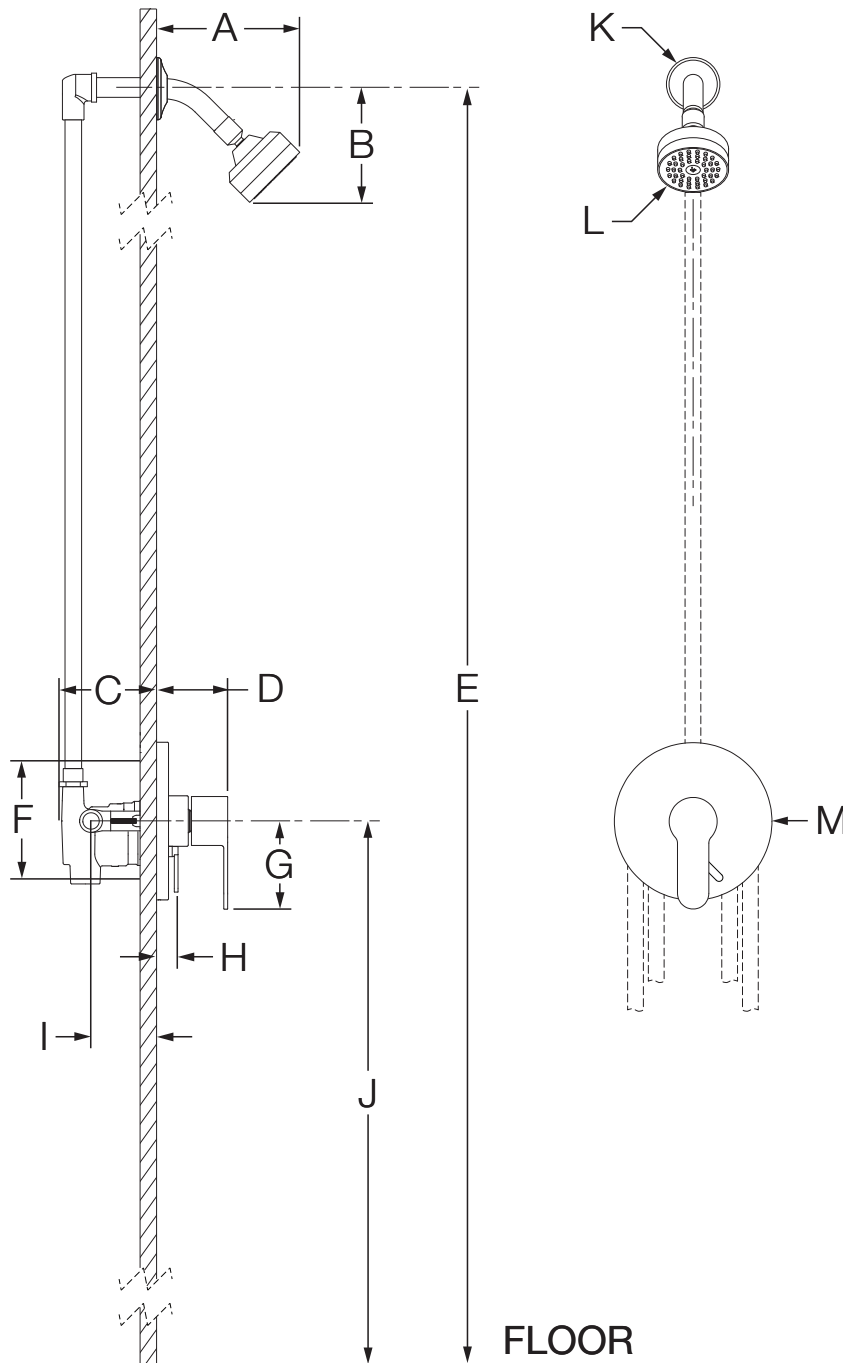

Measurements	
A	5-7/8", 149 mm
B	4-5/8", 117 mm
C	3-1/2", 89 mm
D	2-7/8", 73 mm
E	Ref. 77", 1956 mm
F	Shower Valve Hole Size Min. Ø 3", 76 mm Max. Ø 4", 102 mm
G	3-1/2", 89 mm
H	7/8", 22 mm
I	Rough-in 2-3/8" ± 1/2", 60 mm ± 13 mm
J	Ref. 42", 1067 mm
K	Ø 2-1/2", 64 mm
L	Ø 3-1/8", 79 mm
M	Ø 6-3/8", 162 mm

Notes:

- 1) All dimensions measured from nominal rough-in (see I as reference).
- 2) Dimensions subject to change without notice.