









Location:

Origins™

9604-PLR Tub/Hand Shower System Specification Submittal



Model Numbers	Specification
<input type="checkbox"/> 9604-PLR <i>Origins Tub/Hand Shower System</i>	<p>Tub/hand shower system powered by the Temptrol® Pressure Balancing valve. Features adjustable stop screw to limit handle turn, 36" slide bar, diverter tub spout, in-line vacuum breaker, 60" flexible metal hose, ADA hand shower and standard 2.5 gpm (9.5 L/min) flow restrictor. Components made from metal and nonmetallic materials plated in standard polished chrome finish.</p> <div style="text-align: right;">   </div>
<p>Modifications</p> <ul style="list-style-type: none"> <input type="checkbox"/> -1.5  1.5 gpm (5.7 L/min) flow restrictor <input type="checkbox"/> -2.0  2.0 gpm (7.6 L/min) flow restrictor <input type="checkbox"/> -SS Slip spout on any tub/shower unit <input type="checkbox"/> -X Integral service stops <input type="checkbox"/> -CHKS Integral check stops <input type="checkbox"/> -IPS 1/2" female IPS connections <input type="checkbox"/> -REV Reverse coring for back to back installations <input type="checkbox"/> -LP Loop handle <input type="checkbox"/> -B Chrome brass escutcheon <input type="checkbox"/> -D Chrome brass dome cover <input type="checkbox"/> -VP Vandal proof escutcheon screws <input type="checkbox"/> -QD Quick disconnect on hand shower units <input type="checkbox"/> -R White vinyl hose in place of metal hose <input type="checkbox"/> -VB Elevated vacuum breaker <input type="checkbox"/> -OP 13" oval plate <input type="checkbox"/> -72 6' hose in place of 5' standard <input type="checkbox"/> -B30 30" adjusting bar in place of standard 36" bar <input type="checkbox"/> -B48 48" adjusting bar in place of standard 36" bar <input type="checkbox"/> -L/GB Less grab bar <input type="checkbox"/> -T24 24" grab bar in place of standard 36" bar <input type="checkbox"/> -TRM Trim only, valve not included <input type="checkbox"/> -STN Satin Nickel finish <p>Note: Append appropriate -suffix to model number.</p>	<p>Compliance</p> <ul style="list-style-type: none"> -ASME A112.18.1/CSA B125.1 -WaterSense 1.5 gpm (5.7 L/min) 2.0 gpm (7.6 L/min) <div style="text-align: right;">   </div> <p>Warranty</p> <p>Limited Lifetime - to the original end purchaser in consumer/residential installations. 5 Years - for industrial/commercial installations. Refer to www.symmons.com/warranty for complete warranty information.</p>

Dimensions

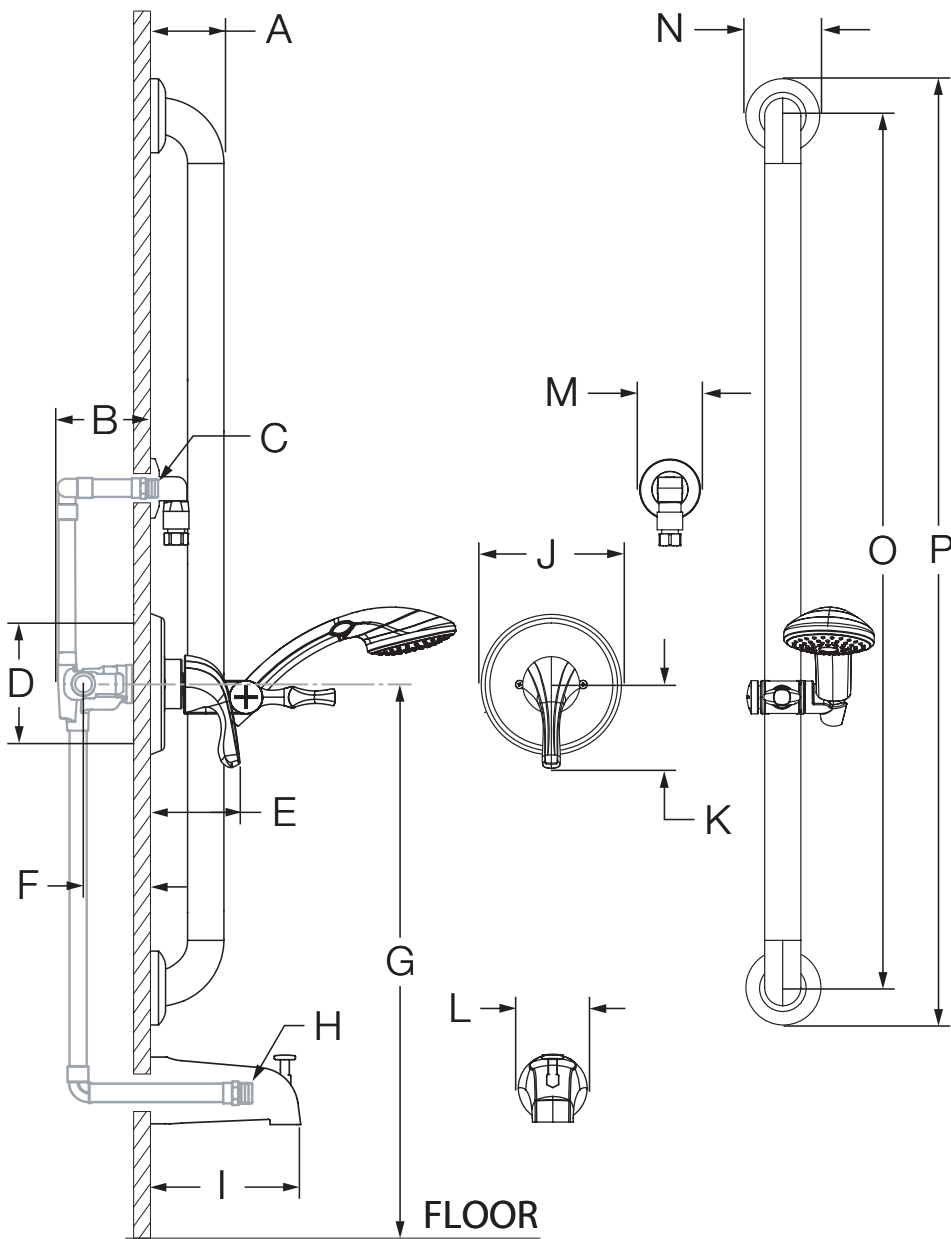

Measurements	
A	3", 76 mm
B	3 1/2", 89 mm
C	Male 1/2" NPT fitting must protrude 3/8" from finished wall
D	Shower Valve Hole Size Min. Ø 3", 76 mm Max. Ø 4", 102 mm
E	3 5/8", 92 mm
F	Rough-in 2 3/8" ± 1/2", 60 mm ± 13 mm
G	Ref. 32", 813 mm
H	Male 1/2" NPT thread must protrude 4" from finished wall
I	5 1/4", 133 mm
J	Ø 5 3/4", 146 mm
K	3 3/8", 86 mm
L	Ø 2 1/2", 64 mm
M	Ø 2 1/2", 64 mm
N	Ø 3 1/8", 79 mm
O	36", 914 mm
P	39", 991 mm

Notes:







- 1) All dimensions measured from nominal rough-in (see F as reference).
- 2) Dimensions subject to change without notice.

9604-PLR

Système de baignoire avec douche à main

Présentation des spécifications



Numéro de modèle	Spécification
<input type="checkbox"/> 9604-PLR <i>Système de baignoire avec douche à main Origins</i>	<p>Le système de baignoire avec douche à main comprend la vanne à pression autorégulée Temptrol®. Figurer la vis d'arrêt réglable pour limiter le tournage de la poignée, une barre de glissement de 36 po, un bec de baignoire déviateur, un reniflard de ligne, 60 po tuyau flexible en métal et 1 douche à main avec un réducteur de débit régulier de 2,5 gpm (9,5 L/min). Les composants sont faits de matériaux métalliques et non métalliques au fini chrome poli standard.</p>  
<p>Modifications</p>	
<input type="checkbox"/> -1.5  Régulateur de débit de 1,5 gpm (5,7 L/min)	<p>Conforme</p> <p>-ASME A112.18.1/CSA B125.1 -WaterSense 1.5 gpm (5.7 L/min) 2.0 gpm (7.6 L/min)</p>  
<input type="checkbox"/> -2.0  Régulateur de débit de 2,0 gpm (7,6 L/min)	
<input type="checkbox"/> -SS <i>Bec de baignoire à enfiler unité baignoire-douche</i>	<p>Garantie</p>
<input type="checkbox"/> -X <i>Robinet d'interruption du service</i>	<p>À vie limitée - à l'acheteur original dans les installations du consommateur ou résidentielles.</p>
<input type="checkbox"/> -CHKS <i>Valve d'arrêt intégrée</i>	<p>5 ans - pour des installations commerciales et industrielles. Se reporter au site www.symmons.com/warranty (en anglais) pour l'information complète concernant la garantie.</p>
<input type="checkbox"/> -IPS <i>Raccords IPS femelles de 1/2 po</i>	
<input type="checkbox"/> -REV <i>Corps central inversé our installations dos à dos</i>	
<input type="checkbox"/> -LP <i>Poignée en boucle</i>	
<input type="checkbox"/> -B <i>Vanne de la rosace chrome laiton</i>	
<input type="checkbox"/> -D <i>Couvercle en dôme chrome laiton</i>	
<input type="checkbox"/> -VP <i>Vis de rosace résistant au vandalisme</i>	
<input type="checkbox"/> -QD <i>Débranchement rapide pour de douche à main</i>	
<input type="checkbox"/> -R <i>Tuyau de vinyle blanc</i>	
<input type="checkbox"/> -VB <i>Reniflard surélevé</i>	
<input type="checkbox"/> -OP <i>Assiette ovale 13 po</i>	
<input type="checkbox"/> -72 <i>Tuyau de 6' au lieu de 5' standard</i>	
<input type="checkbox"/> -B30 <i>Réglage barre 30 po à la place de la barre standard</i>	
<input type="checkbox"/> -B48 <i>Réglage barre 48 po à la place de la barre standard</i>	
<input type="checkbox"/> -L/GB <i>Aucune barre d'appui</i>	
<input type="checkbox"/> -T24 <i>Barre d'appui 24 po à la place de la barre standard</i>	
<input type="checkbox"/> -TRM <i>Garniture seulement, vanne non incluse</i>	
<input type="checkbox"/> -STN <i>Fini nickel satiné</i>	
<p>Remarque: Juxtaposer le -suffixe approprié au numéro de modèle.</p>	

Dimensions

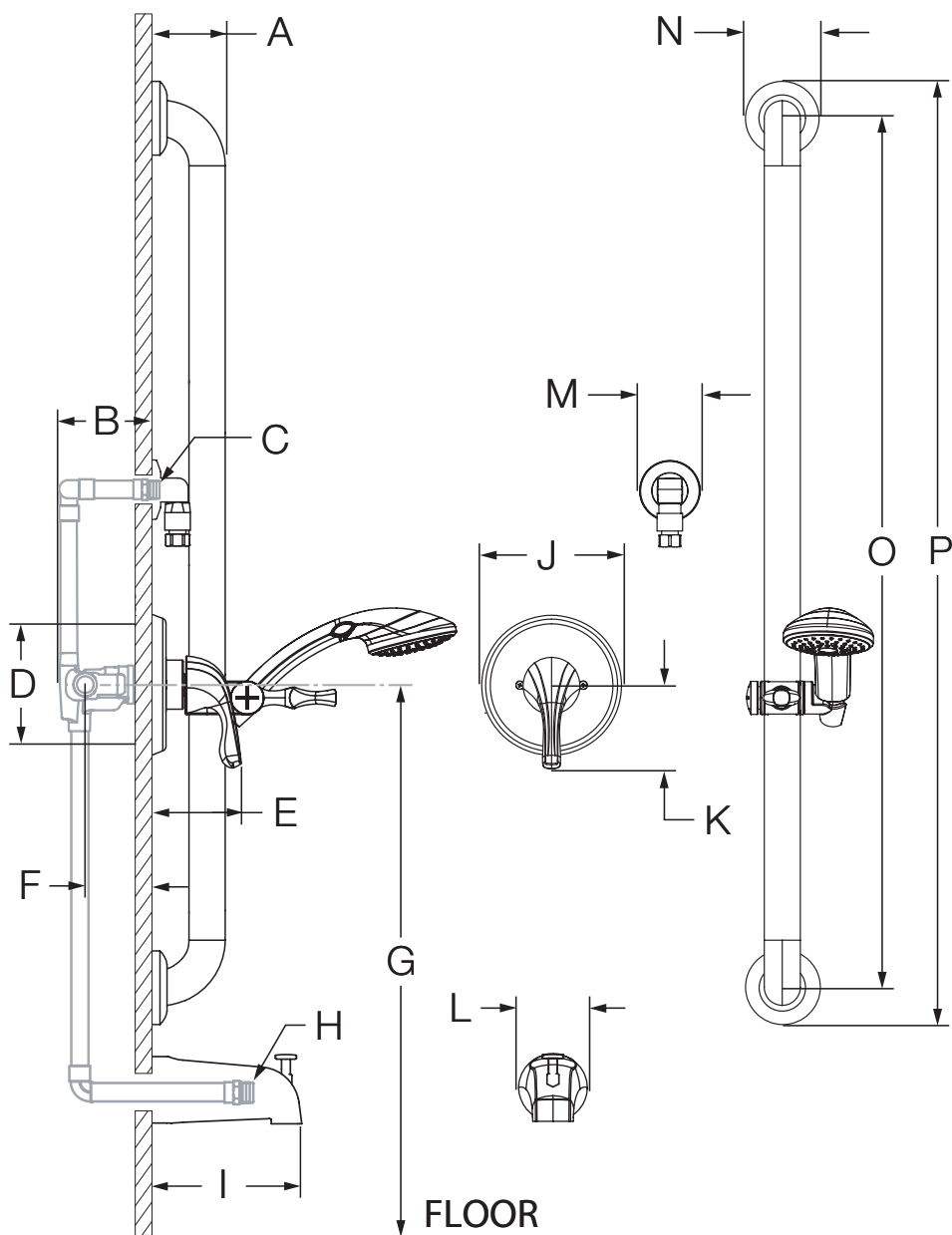

Mesures	
A	3 po, 76 mm
B	3 1/2 po, 89 mm
C	1/2 po mâle à filets NPT doit faire saillie de 3/8 po du mur fini
D	Taille du trou Min. Ø 3 po, 76 mm Max. Ø 4 po, 102 mm
E	3 5/8 po, 92 mm
F	Robinetterie brute 2 3/8 po ± 1/2 po, 60 mm ± 13 mm
G	Réf. 32 po, 813 mm
H	1/2 po mâle à filets NPT doit faire saillie de 4 po du mur fini
I	5 1/4 po, 133 mm
J	Ø 5 3/4 po, 146 mm
K	3 3/8 po, 86 mm
L	Ø 2 1/2 po, 64 mm
M	Ø 2 1/2 po, 64 mm
N	Ø 3 1/8 po, 79 mm
O	36 po, 914 mm
P	39 po, 991 mm

Remarques:

- 1) Toutes les dimensions sont mesurées à partir de la robinetterie brute nominale (voir F en référence).
- 2) Les dimensions sont sujettes à changer sans préavis.