









SYMMONS®
the smart choice™

Location:



S-9603-PLR
Hand Shower System
Specification Submittal

Specification	Modifications
<p>Hand shower system powered by the Temptrol® Pressure Balancing valve with integral volume control. Hand shower system shall include adjustable stop screw to limit handle turn, 36" slide bar, in-line vacuum breaker, 60" flexible metal hose, ADA hand shower and standard 2.5 gpm (9.5 L/min) flow restrictor. Components shall be made from metal and nonmetallic construction, plated in standard polished chrome finish.</p>  	
<p>Model Numbers</p>	
<p><input type="checkbox"/> S-9603-PLR <i>Origins hand shower system</i></p> <p><input type="checkbox"/> S-9603-PLR-TRM <i>Origins hand shower, trim only</i></p> <p><input type="checkbox"/> S-46-1-BODY <i>Temptrol Pressure Balancing shower valve body</i></p> <p><input type="checkbox"/> S-46-1X-BODY <i>Temptrol Pressure Balancing shower valve body with stops</i></p>	<p><input type="checkbox"/> CG -1.5 1.5 gpm (5.7 L/min) flow restrictor</p> <p><input type="checkbox"/> -2.0 2.0 gpm (7.6 L/min) flow restrictor</p> <p><input type="checkbox"/> -72 72" hose in place of 60" hose</p> <p><input type="checkbox"/> -ADAHS ADA hand shower wand (white)</p> <p><input type="checkbox"/> -B Brass escutcheon (chrome only)</p> <p><input type="checkbox"/> -CHKS Integral check stops - for use in installations where a positive shut-off device is used downstream of mixing valve</p> <p><input type="checkbox"/> -D Brass dome cover (chrome only)</p> <p><input type="checkbox"/> -H321-V 1 mode hand shower unit with slide bar in place of standard hand shower unit</p> <p><input type="checkbox"/> -H323-V 3 mode hand shower unit with slide bar in place of standard hand shower unit</p> <p><input type="checkbox"/> -IPS 1/2" female IPS connections</p> <p><input type="checkbox"/>  -LAM Lever handle</p> <p><input type="checkbox"/>  -LP Loop handle</p> <p><input type="checkbox"/> -L/HS Less hand shower</p> <p><input type="checkbox"/> -OP 13" oval plate (PLR only)</p> <p><input type="checkbox"/> -QD Quick-disconnect on hand spray units</p> <p><input type="checkbox"/> -R 60" white vinyl hose in place of 60" metal hose</p> <p><input type="checkbox"/> -REB Rebuild trim kit, includes TA-10 and TA-4</p> <p><input type="checkbox"/> -REV Reverse coring, hot on right, cold on left, for back to back installations</p> <p><input type="checkbox"/> -T724 24" slide bar/grab bar with ADA hand shower in place of standard hand shower unit</p> <p><input type="checkbox"/> -T748 48" slide bar/grab bar with ADA hand shower in place of standard hand shower unit</p> <p><input type="checkbox"/> -VB Elevated vacuum breaker</p> <p><input type="checkbox"/> -VP Vandal resistant escutcheon screws in place of standard screws</p> <p><input type="checkbox"/> -X Integral service stops - allows water shutoff at valve for service</p>
<p>Finish Options</p>	
<p><input type="checkbox"/> -STN <i>Satin Nickel finish</i></p>	
<p>Compliance</p> <p>-ASME A112.18.1/CSA B125.1</p> <p>-WaterSense 1.5 gpm (5.7 L/min) 2.0 gpm (7.6 L/min)</p>  	
<p>Warranty</p>	
<p>Limited Lifetime - to the original end purchaser in consumer/residential installations. 5 Years - for industrial/commercial installations. Refer to www.symmons.com/warranty for complete warranty information.</p>	<p>Note: Append appropriate -suffix to model number.</p>

Dimensions

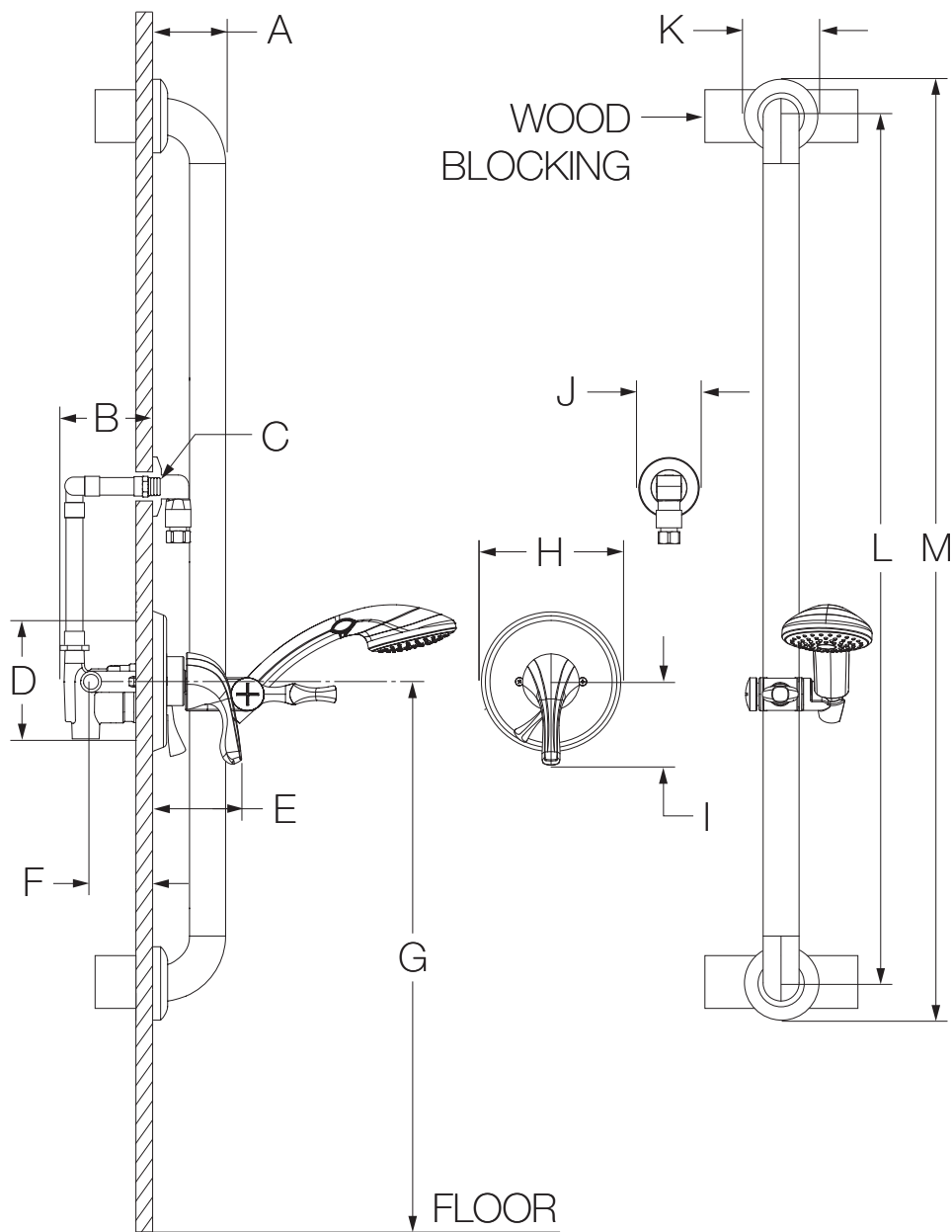

Measurements	
A	3", 76 mm
B	3-1/2", 89 mm
C	Male 1/2" NPT fitting must protrude 3/8" from finished wall
D	Shower Valve Hole Size Min. Ø 3", 76 mm Max. Ø 4", 102 mm
E	3-5/8", 92 mm
F	Rough-in 2-3/8" ± 1/2", 60 mm ± 13 mm
G	Ref. 32", 813 mm
H	Ø 5-3/4", 146 mm
I	3-3/8", 86 mm
J	Ø 2-1/2", 64 mm
K	Ø 3-1/8", 79 mm
L	36", 914 mm
M	39", 991 mm

Notes:







- 1) All dimensions measured from nominal rough-in (see F as reference).
- 2) Dimensions subject to change without notice.

S-9603-PLR

Système douche à main

Présentation des spécifications



Spécification	Modifications
<p>Le système de douche à main comprend la vanne à pression autorégularisée Temptrol® avec contrôle du volume intégré. Figurer la vis d'arrêt réglable pour limiter le tournage de la poignée, une barre de glissement de 36 po, 60 po tuyau flexible en métal et 1 douche à main avec un réducteur de débit régulier de 2,5 gpm (9,5 L/min). Les composants sont faits de matériaux métalliques et non métalliques au fini chrome poli standard.</p>  	<ul style="list-style-type: none"> <input type="checkbox"/> CG -1.5 Régulateur de débit de 1,5 gpm (5,7 L/min) <input type="checkbox"/> -2.0 Régulateur de débit de 2,0 gpm (7,6 L/min) <input type="checkbox"/> -72 Tuyau de 72 po à la place du tuyau de 60 po <input type="checkbox"/> -ADAHS Douche à main ADA (blanc) <input type="checkbox"/> -B Vanne de la rosace chrome laiton <input type="checkbox"/> -CHKS Valve d'arrêt intégrée <input type="checkbox"/> -D Couvercle en dôme chrome laiton <input type="checkbox"/> -H321-V Douche à main à 1 mode avec barre coulissante au lieu de l'unité de douche à main standard
<h3>Numéro de modèle</h3> <ul style="list-style-type: none"> <input type="checkbox"/> S-9603-PLR <i>Système de douche à main Origins</i> <input type="checkbox"/> S-9603-PLR-TRM <i>Garniture seulement de douche à main Origins</i> <input type="checkbox"/> S-46-1-BODY <i>Pression autorégularisée Temptrol</i> <input type="checkbox"/> S-46-1X-BODY <i>Pression autorégularisée robinet d'interruption du service Temptrol</i> 	<ul style="list-style-type: none"> <input type="checkbox"/> -H323-V Douche à main à 3 modes avec barre coulissante au lieu de l'unité de douche à main standard <input type="checkbox"/> -IPS Raccords IPS femelles de 1/2 po <input type="checkbox"/>  -LAM Poignée du levier <input type="checkbox"/>  -LP Poignée de boucle <input type="checkbox"/> -L/HS Sans douche à main <input type="checkbox"/> -OP Assiette ovale 13 po <input type="checkbox"/> -QD Débranchement rapide pour de douche à main <input type="checkbox"/> -R Tuyau de vinyle blanc <input type="checkbox"/> -REB L'ensemble de remise en état de la finition, incluant TA-10 et TA-4 <input type="checkbox"/> -REV Corps central inversé our installations dos à dos <input type="checkbox"/> -T724 Barre à glissière de 24 po barre d'appui avec douchette à main ADA <input type="checkbox"/> -T748 Barre à glissière de 48 po barre d'appui avec douchette à main ADA
<h3>Options de finition</h3> <ul style="list-style-type: none"> <input type="checkbox"/> -STN <i>Fini nickel satiné</i> 	<ul style="list-style-type: none"> <input type="checkbox"/> -REB L'ensemble de remise en état de la finition, incluant TA-10 et TA-4 <input type="checkbox"/> -REV Corps central inversé our installations dos à dos <input type="checkbox"/> -T724 Barre à glissière de 24 po barre d'appui avec douchette à main ADA <input type="checkbox"/> -T748 Barre à glissière de 48 po barre d'appui avec douchette à main ADA
<h3>Conforme</h3> <ul style="list-style-type: none"> -ASME A112.18.1/CSA B125.1 -WaterSense 1.5 gpm (5.7 L/min) 2.0 gpm (7.6 L/min)  	<ul style="list-style-type: none"> <input type="checkbox"/> -VB Reniflard surélevé <input type="checkbox"/> -VP Des vis anti-vandalisme de la rosace remplacent les vis régulières <input type="checkbox"/> -X Robinet d'interruption du service
<h3>Garantie</h3> <p>À vie limitée - à l'acheteur original dans les installations du consommateur ou résidentielles.</p> <p>5 ans - pour des installations commerciales et industrielles. Se reporter au site www.symmons.com/warranty (en anglais) pour l'information complète concernant la garantie.</p>	<p>Remarque: Juxtaposer le -suffixe approprié au numéro de modèle.</p>

Dimensions

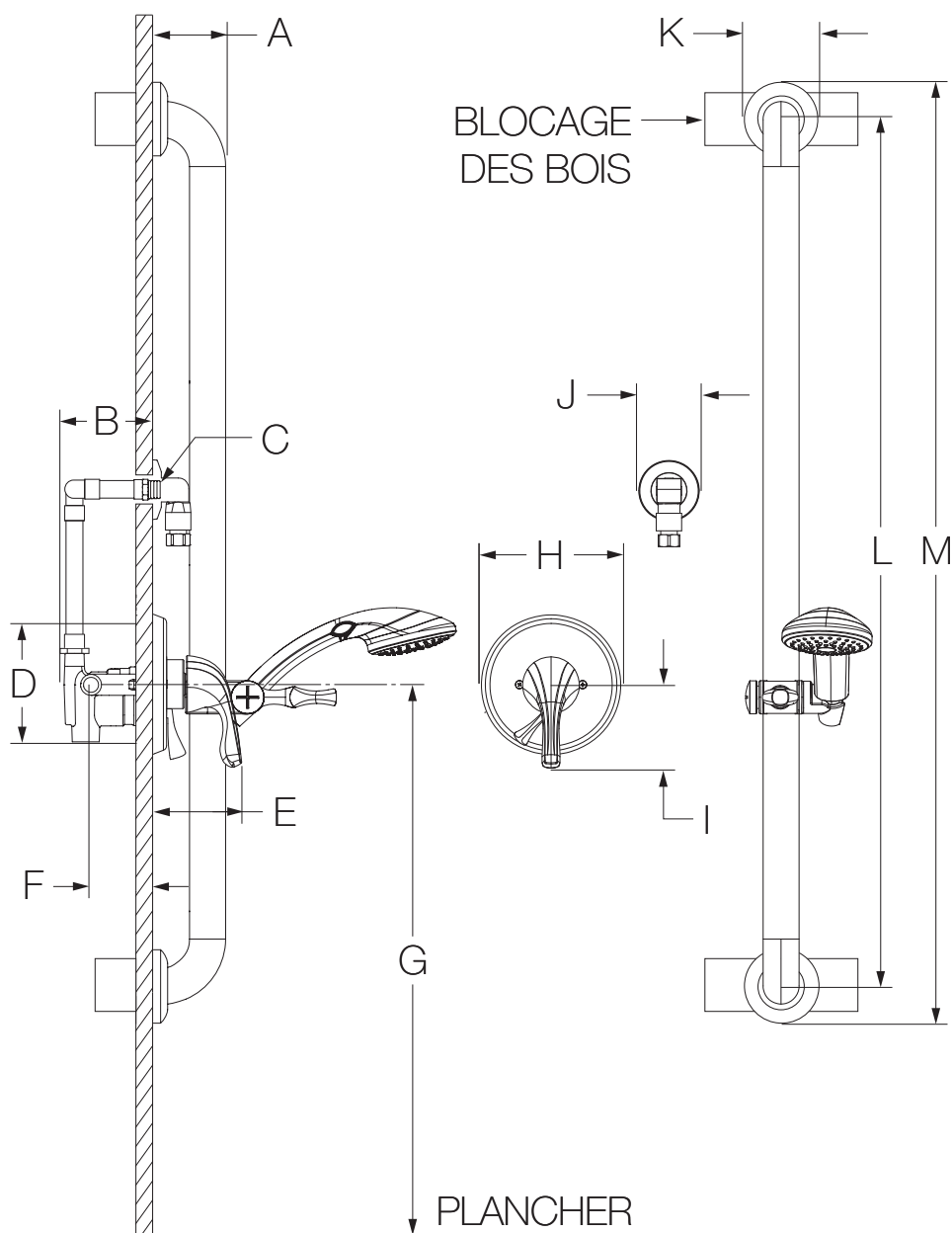

Mesures	
A	3 po, 76 mm
B	3-1/2 po, 89 mm
C	1/2 po mâle à filets NPT doit faire saillie de 3/8 po du mur fini
D	Taille du trou Min. Ø 3 po, 76 mm Max. Ø 4 po, 102 mm
E	3-5/8 po, 92 mm
F	Robinetterie brute 2-3/8 po ± 1/2 po, 60 mm ± 13 mm
G	Réf. 32 po, 813 mm
H	Ø 5-3/4 po, 146 mm
I	3-3/8 po, 86 mm
J	Ø 2-1/2 po, 64 mm
K	Ø 3-1/8 po, 79 mm
L	36 po, 914 mm
M	39 po, 991 mm

Remarques:

- 1) Toutes les dimensions sont mesurées à partir de la robinetterie brute nominale (voir F en référence).
- 2) Les dimensions sont sujettes à changer sans préavis.