









SYMMONS®
the smart choice™

Location:



S-9602-PLR
Tub/Shower System
Specification Submittal

Specification	Modifications
<p>Tub/shower system powered by the Temptrol® Pressure Balancing valve with integral diverter. Tub/shower system shall include adjustable stop screw to limit handle turn, non-diverter tub spout, 1 mode showerhead with easy to clean rubber nozzles and standard 2.5 gpm (9.5 L/min) flow restrictor. Components shall be made from metal and nonmetallic construction, plated in standard polished chrome finish.</p>  	<ul style="list-style-type: none"> <input type="checkbox"/> CG -1.5 1.5 gpm (5.7 L/min) flow restrictor <input type="checkbox"/> -2.0 2.0 gpm (7.6 L/min) flow restrictor <input type="checkbox"/> -143 3 mode showerhead in place of standard head <input type="checkbox"/> -145 5 mode showerhead in place of standard head <input type="checkbox"/> -231 Super showerhead in place of standard head <input type="checkbox"/> -295 Institutional showerhead (chrome only) <input type="checkbox"/> -B Brass escutcheon (chrome only) <input type="checkbox"/> -CHKS Integral check stops - for use in installations where a positive shut-off device is used downstream of mixing valve
<p>Model Numbers</p>	<ul style="list-style-type: none"> <input type="checkbox"/> -D Brass dome cover (chrome only) <input type="checkbox"/> -IPS 1/2" female IPS connections
<ul style="list-style-type: none"> <input type="checkbox"/> S-9602-PLR <i>Origins tub/shower system</i> <input type="checkbox"/> S-9602-PLR-TRM <i>Origins tub/shower, trim only</i> <input type="checkbox"/> S-46-2-BODY <i>Temptrol Pressure Balancing tub/shower valve body</i> <input type="checkbox"/> S-46-2X-BODY <i>Temptrol Pressure Balancing tub/shower valve body with stops</i> 	<ul style="list-style-type: none"> <input type="checkbox"/>  -LAM Lever handle <input type="checkbox"/>  -LP Loop handle <input type="checkbox"/> -L/HD Less showerhead <input type="checkbox"/> -OP 13" oval plate (PLR only) <input type="checkbox"/> -REB Rebuild trim kit, includes TA-10 and TA-4 <input type="checkbox"/> -REV Reverse coring, hot on right, cold on left, for back to back installations <input type="checkbox"/> -SS Slip spout on any tub/shower unit
<p>Finish Options</p>	<ul style="list-style-type: none"> <input type="checkbox"/> -VP Vandal resistant escutcheon screws in place of standard screws
<ul style="list-style-type: none"> <input type="checkbox"/> -STN <i>Satin Nickel finish</i> 	<ul style="list-style-type: none"> <input type="checkbox"/> -X Integral service stops - allows water shutoff at valve for service
<p>Compliance</p> <p>-ASME A112.18.1/CSA B125.1 -WaterSense 1.5 gpm (5.7 L/min) 2.0 gpm (7.6 L/min)</p>  	
<p>Warranty</p>	
<p>Limited Lifetime - to the original end purchaser in consumer/residential installations. 5 Years - for industrial/commercial installations. Refer to www.symmons.com/warranty for complete warranty information.</p>	<p>Note: Append appropriate -suffix to model number.</p>

Dimensions

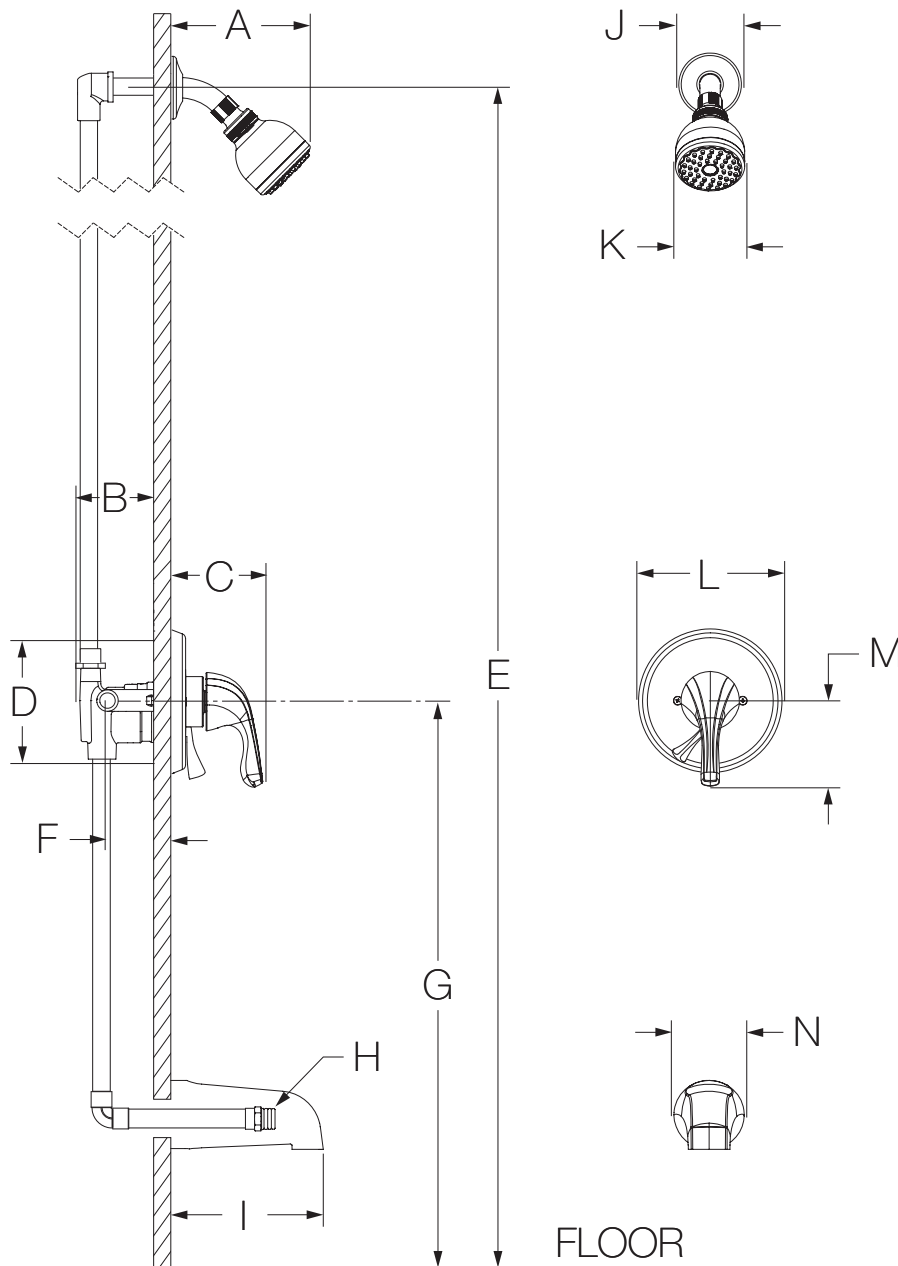

Measurements	
A	6-3/8", 162 mm
B	3-1/2", 89 mm
C	3-5/8", 92 mm
D	Shower Valve Hole Size Min. Ø 3", 76 mm Max. Ø 4", 102 mm
E	Ref. 77", 1956 mm
F	Rough-in 2-3/8" ± 1/2", 60 mm ± 13 mm
G	Ref. 32", 813 mm
H	Male 1/2" NPT fitting must protrude 4" from finished wall
I	5-1/2", 140 mm
J	Ø 2-1/2", 64 mm
K	Ø 2-3/4", 70 mm
L	Ø 5-3/4", 146 mm
M	3-3/8", 86 mm
N	Ø 2-1/2", 64 mm

Notes:

- 1) All dimensions measured from nominal rough-in (see F as reference).
- 2) Dimensions subject to change without notice.



Emplacement:

SYMMONS® Origins®







the smart choice™

S-9602-PLR

Système de baignoire-douche

Présentation des spécifications



Spécification	Modifications
<p>Le système de baignoire-douche comprend la vanne à pression autorégularisée Temptrol® avec déviateur intégré. Figurer la vis d'arrêt réglable pour limiter le tournage de la poignée, un bec de baignoire déviateur, 1 pomme de douche avec facile à nettoyer les buses en caoutchouc et réducteur de débit régulier de 2,5 gpm (9,5 L/min). Les composants sont faits de matériaux métalliques et non métalliques au fini chrome poli standard.</p>  	<ul style="list-style-type: none"> <input type="checkbox"/> CG -1.5 Régulateur de débit de 1,5 gpm (5,7 L/min) <input type="checkbox"/> -2.0 Régulateur de débit de 2,0 gpm (7,6 L/min) <input type="checkbox"/> -143 Pomme de douche à 3 modes <input type="checkbox"/> -145 Pomme de douche à 5 modes <input type="checkbox"/> -231 Super pomme de douche <input type="checkbox"/> -295 Pomme de douche institutionnelle <input type="checkbox"/> -B Vanne de la rosace chrome laiton <input type="checkbox"/> -CHKS Valve d'arrêt intégrée <input type="checkbox"/> -D Couvercle en dôme chrome laiton <input type="checkbox"/> -IPS Raccords IPS femelles de 1/2 po <input type="checkbox"/>  -LAM Poignée du levier <input type="checkbox"/>  -LP Poignée de boucle <input type="checkbox"/> -L/HD Sans pomme de douche <input type="checkbox"/> -OP Assiette ovale 13 po <input type="checkbox"/> -REB L'ensemble de remise en état de la finition, incluant TA-10 et TA-4 <input type="checkbox"/> -REV Corps central inversé our installations dos à dos <input type="checkbox"/> -SS Bec de baignoire à enfiler unité baignoire-douche <input type="checkbox"/> -VP Des vis anti-vandalisme de la rosace remplacent les vis régulières <input type="checkbox"/> -X Robinet d'interruption du service
<h3>Numéro de modèle</h3>	
<ul style="list-style-type: none"> <input type="checkbox"/> S-9602-PLR <i>Système de baignoire-douche Origins</i> <input type="checkbox"/> S-9602-PLR-TRM <i>Garniture seulement de baignoire-douche Origins</i> <input type="checkbox"/> S-46-2-BODY <i>Pression autorégularisée Temptrol</i> <input type="checkbox"/> S-46-2X-BODY <i>Pression autorégularisée robinet d'interruption du service Temptrol</i> 	
<h3>Options de finition</h3>	
<ul style="list-style-type: none"> <input type="checkbox"/> -STN <i>Fini nickel satiné</i> 	
<h3>Conforme</h3>	
<p>-ASME A112.18.1/CSA B125.1 -WaterSense 1.5 gpm (5.7 L/min) 2.0 gpm (7.6 L/min)</p>  	
<h3>Garantie</h3>	
<p>À vie limitée - à l'acheteur original dans les installations du consommateur ou résidentielles. 5 ans - pour des installations commerciales et industrielles. Se reporter au site www.symmons.com/warranty (en anglais) pour l'information complète concernant la garantie.</p>	

Remarque: Juxtaposer le -suffixe approprié au numéro de modèle.

Dimensions

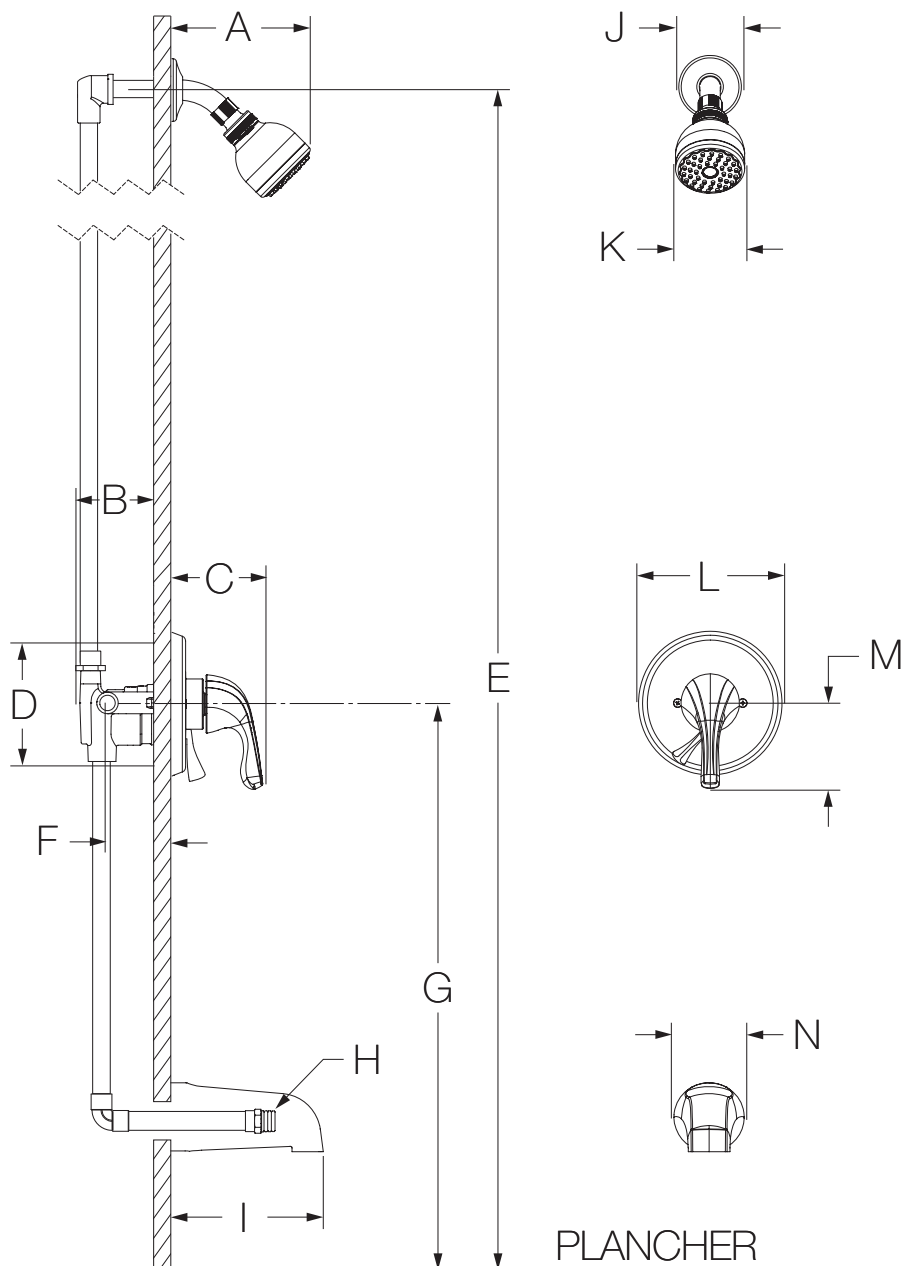

Mesures	
A	6-3/8 po, 162 mm
B	3-1/2 po, 89 mm
C	3-5/8 po, 92 mm
D	Taille du trou Min. Ø 3 po, 76 mm Max. Ø 4 po, 102 mm
E	Réf. 77 po, 1956 mm
F	Robinetterie brute 2-3/8 po ± 1/2 po, 60 mm ± 13 mm
G	Réf. 32 po, 813 mm
H	1/2 po mâle à filets NPT doit faire saillie de 4 po du mur fini
I	5-1/2 po, 140 mm
J	Ø 2-1/2 po, 64 mm
K	Ø 2-3/4 po, 70 mm
L	Ø 5-3/4 po, 146 mm
M	3-3/8 po, 86 mm
N	Ø 2-1/2 po, 64 mm

Remarques:

- 1) Toutes les dimensions sont mesurées à partir de la robinetterie brute nominale (voir F en référence).
- 2) Les dimensions sont sujettes à changer sans préavis.