









Location:

# Origins™

S-9602-PLR  
Tub/Shower System

## Specification Submittal



Model Numbers	Specification
<input type="checkbox"/> <b>S-9602-PLR</b> <i>Origins Tub/Shower System</i>	<p>Tub/shower system powered by the Temptrol® Pressure Balancing valve. Features adjustable stop screw to limit handle turn, integrated diverter, non-diverter tub spout, 1 mode showerhead with easy to clean rubber nozzles and standard 2.5 gpm (9.5 L/min) flow restrictor. Components made from metal and nonmetallic materials plated in standard polished chrome finish.</p> <div style="text-align: right;">   </div>
<p><b>Modifications</b></p> <ul style="list-style-type: none"> <li><input type="checkbox"/> <b>-1.5</b>  1.5 gpm (5.7 L/min) flow restrictor</li> <li><input type="checkbox"/> <b>-2.0</b>  2.0 gpm (7.6 L/min) flow restrictor</li> <li><input type="checkbox"/> <b>-231</b> Super showerhead in place of Clear-Flo</li> <li><input type="checkbox"/> <b>-295</b> Institutional showerhead in place of Clear-Flo</li> <li><input type="checkbox"/> <b>-SS</b> Slip spout on any tub/shower unit</li> <li><input type="checkbox"/> <b>-X</b> Integral service stops</li> <li><input type="checkbox"/> <b>-CHKS</b> Integral check stops</li> <li><input type="checkbox"/> <b>-IPS</b> 1/2" female IPS connections</li> <li><input type="checkbox"/> <b>-REV</b> Reverse coring for back to back installations</li> <li><input type="checkbox"/> <b>-LP</b> Loop handle</li> <li><input type="checkbox"/> <b>-B</b> Chrome brass escutcheon</li> <li><input type="checkbox"/> <b>-D</b> Chrome brass dome cover</li> <li><input type="checkbox"/> <b>-VP</b> Vandal proof escutcheon screws</li> <li><input type="checkbox"/> <b>-OP</b> 13" oval plate</li> <li><input type="checkbox"/> <b>-L/HD</b> Less showerhead</li> <li><input type="checkbox"/> <b>-TRM</b> Trim only, valve not included</li> <li><input type="checkbox"/> <b>-STN</b> Satin Nickel finish</li> </ul> <p><b>Note:</b> Append appropriate -suffix to model number.</p>	
<b>Compliance</b>	
<p>-ASME A112.18.1/CSA B125.1          -WaterSense 1.5 gpm (5.7 L/min)          2.0 gpm (7.6 L/min)</p> <div style="text-align: right;">   </div>	
<b>Warranty</b>	
<p><b>Limited Lifetime</b> - to the original end purchaser in consumer/residential installations.  <b>5 Years</b> - for industrial/commercial installations.          Refer to <a href="http://www.symmons.com/warranty">www.symmons.com/warranty</a> for complete warranty information.</p>	

## Dimensions

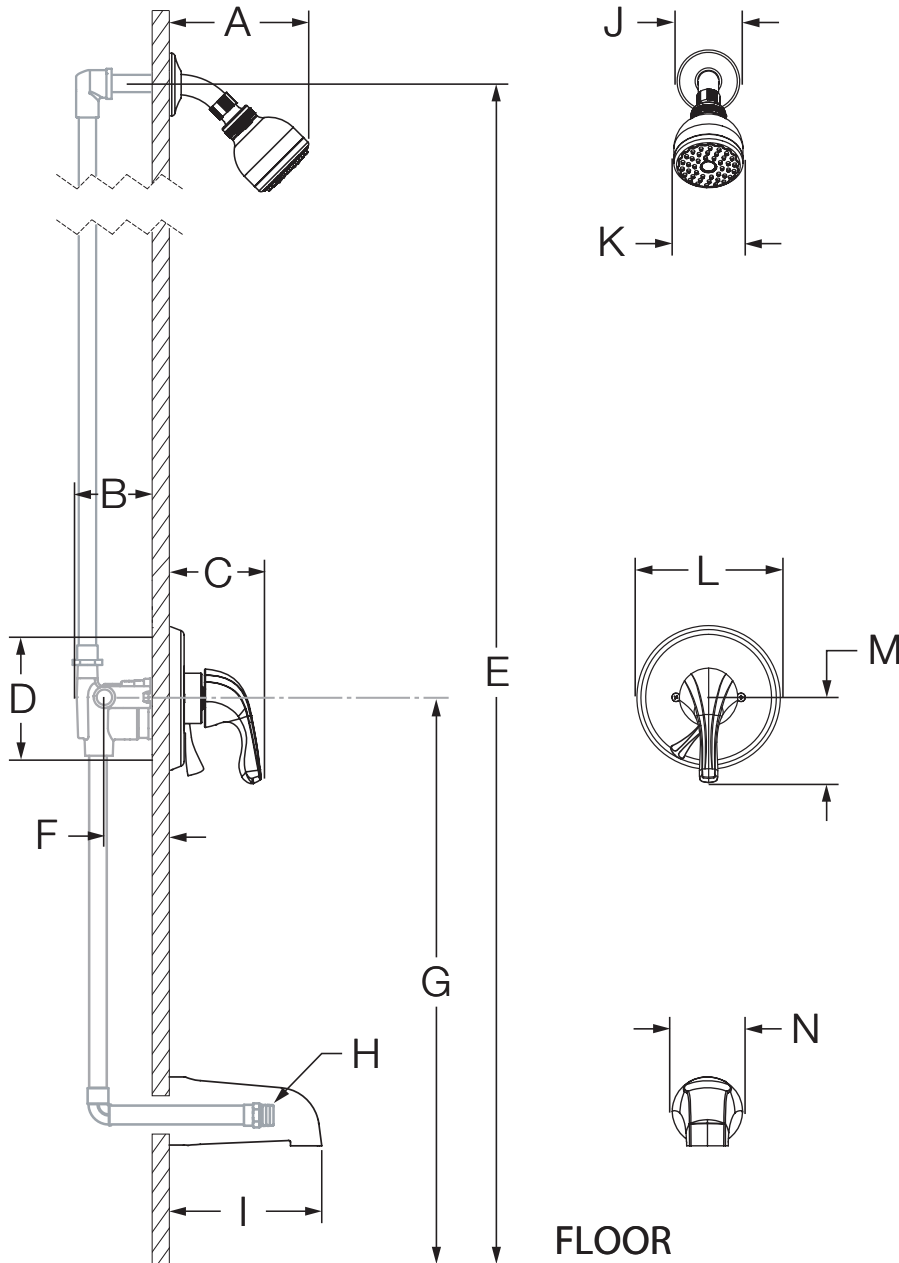

Measurements	
A	6 3/8", 162 mm
B	3 1/2", 89 mm
C	3 5/8", 92 mm
D	Shower Valve Hole Size Min. Ø 3", 76 mm Max. Ø 4", 102 mm
E	Ref. 77", 1956 mm
F	Rough-in 2 3/8" ± 1/2", 60 mm ± 13 mm
G	Ref. 32", 813 mm
H	Male 1/2" NPT fitting must protrude 4" from finished wall
I	5 1/2", 140 mm
J	Ø 2 1/2", 64 mm
K	Ø 2 3/4", 70 mm
L	Ø 5 3/4", 146 mm
M	3 3/8", 86 mm
N	Ø 2 1/2", 64 mm

### Notes:

- 1) All dimensions measured from nominal rough-in (see F as reference).
- 2) Dimensions subject to change without notice.

Emplacement:









**SYMMONS**<sup>®</sup> Origins<sup>™</sup>  
the smart choice<sup>™</sup>

S-9602-PLR

Système de baignoire-douche

**Présentation des spécifications**



Numéro de modèle	Spécification
<input type="checkbox"/> <b>S-9602-PLR</b> <i>Système de baignoire-douche Origins</i>	<p>Le système de baignoire-douche comprend la vanne à pression autorégularisée Temptrol<sup>®</sup>. Figurer la vis d'arrêt réglable pour limiter le tournage de la poignée, un bec de baignoire non-déviateur, 1 pomme de douche avec facile à nettoyer les buses en caoutchouc et réducteur de débit régulier de 2,5 gpm (9,5 L/min). Les composants sont faits de matériaux métalliques et non métalliques au fini chrome poli standard.</p> <div style="text-align: right;">   </div>
<p><b>Modifications</b></p> <ul style="list-style-type: none"> <li><input type="checkbox"/> <b>-1.5</b>  Régulateur de débit de 1,5 gpm (5,7 L/min)</li> <li><input type="checkbox"/> <b>-2.0</b>  Régulateur de débit de 2,0 gpm (7,6 L/min)</li> <li><input type="checkbox"/> <b>-231</b> Super pomme de douche au lieu du Clear-Flo</li> <li><input type="checkbox"/> <b>-295</b> Pomme de douche institutionnelle au lieu du Clear-Flo</li> <li><input type="checkbox"/> <b>-SS</b> Bec de baignoire à enfiler unité baignoire-douche</li> <li><input type="checkbox"/> <b>-X</b> Robinet d'interruption du service</li> <li><input type="checkbox"/> <b>-CHKS</b> Valve d'arrêt intégrée</li> <li><input type="checkbox"/> <b>-IPS</b> Raccords IPS femelles de 1/2 po</li> <li><input type="checkbox"/> <b>-REV</b> Corps central inversé our installations dos à dos</li> <li><input type="checkbox"/> <b>-LP</b> Poignée en boucle</li> <li><input type="checkbox"/> <b>-B</b> Vanne de la rosace chrome laiton</li> <li><input type="checkbox"/> <b>-D</b> Couvercle en dôme chrome laiton</li> <li><input type="checkbox"/> <b>-VP</b> Vis de rosace résistant au vandalisme</li> <li><input type="checkbox"/> <b>-OP</b> Assiette ovale 13 po</li> <li><input type="checkbox"/> <b>-L/HD</b> Sans pomme de douche</li> <li><input type="checkbox"/> <b>-TRM</b> Garniture seulement, vanne non incluse</li> <li><input type="checkbox"/> <b>-STN</b> Fini nickel satiné</li> </ul>	
<p><b>Remarque:</b> Juxtaposer le -suffixe approprié au numéro de modèle.</p>	<p><b>Conforme</b></p> <ul style="list-style-type: none"> <li>-ASME A112.18.1/CSA B125.1</li> <li>-WaterSense 1.5 gpm (5.7 L/min)</li> <li>2.0 gpm (7.6 L/min)</li> </ul> <div style="text-align: right;">   </div>
	<p><b>Garantie</b></p> <p><b>À vie limitée</b> - à l'acheteur original dans les installations du consommateur ou résidentielles.  <b>5 ans</b> - pour des installations commerciales et industrielles.          Se reporter au site <a href="http://www.symmons.com/warranty">www.symmons.com/warranty</a> (en anglais) pour l'information complète concernant la garantie.</p>

## Dimensions

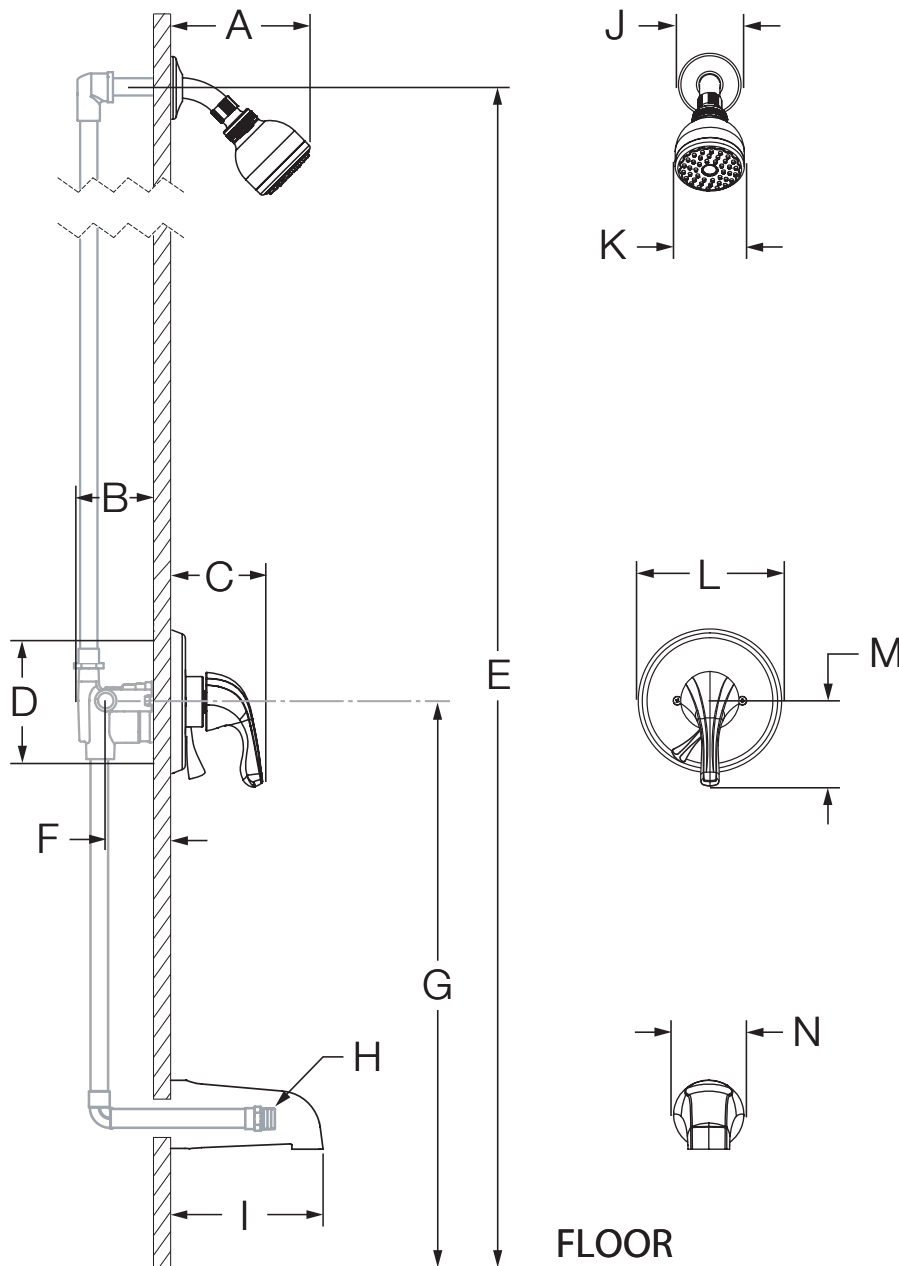

Mesures	
A	6 3/8 po, 162 mm
B	3 1/2 po, 89 mm
C	3 5/8 po, 92 mm
D	Taille du trou Min. Ø 3 po, 76 mm Max. Ø 4 po, 102 mm
E	Réf. 77 po, 1956 mm
F	Robinetterie brute 2 3/8 po ± 1/2 po, 60 mm ± 13 mm
G	Réf. 32 po, 813 mm
H	1/2 po mâle à filets NPT doit faire saillie de 4 po du mur fini
I	5 1/2 po, 140 mm
J	Ø 2 1/2 po, 64 mm
K	Ø 2 3/4 po, 70 mm
L	Ø 5 3/4 po, 146 mm
M	3 3/8 po, 86 mm
N	Ø 2 1/2 po, 64 mm

### Remarques:

- 1) Toutes les dimensions sont mesurées à partir de la robinetterie brute nominale (voir F en référence).
- 2) Les dimensions sont sujettes à changer sans préavis.