







Location:



# Unity™

S-6604  
Tub/Hand Shower System  
**Specification Submittal**



Model Numbers	Specification
<input type="checkbox"/> <b>S-6604</b> <i>Unity Tub/Hand Shower System</i>	<p>Tub/hand shower system powered by the Temptrol® Pressure Balancing valve. Features adjustable stop screw to limit handle turn, integrated diverter, wall cradle, non-diverter tub spout, in-line vacuum breaker, 60" flexible metal hose, hand shower and standard 2.5 gpm (9.5 L/min) flow restrictor. Components made from metal and nonmetallic materials plated in standard polished chrome finish.</p>
<p><b>Modifications</b></p> <ul style="list-style-type: none"> <li><input type="checkbox"/> <b>-1.5</b>  1.5 gpm (5.7 L/min) flow restrictor</li> <li><input type="checkbox"/> <b>-2.0</b>  2.0 gpm (7.6 L/min) flow restrictor</li> <li><input type="checkbox"/> <b>-SS</b> Slip spout on any tub/shower unit</li> <li><input type="checkbox"/> <b>-X</b> Integral service stops</li> <li><input type="checkbox"/> <b>-CHKS</b> Integral check stops</li> <li><input type="checkbox"/> <b>-IPS</b> 1/2" female IPS connections</li> <li><input type="checkbox"/> <b>-REV</b> Reverse coring for back to back installations</li> <li><input type="checkbox"/> <b>-LP</b> Loop handle</li> <li><input type="checkbox"/> <b>-QD</b> Quick disconnect on hand shower units</li> <li><input type="checkbox"/> <b>-R</b> White vinyl hose in place of metal hose</li> <li><input type="checkbox"/> <b>-OP</b> 13" oval plate</li> <li><input type="checkbox"/> <b>-72</b> 6' hose in place of 5' standard</li> <li><input type="checkbox"/> <b>-TRM</b> Trim only, valve not included</li> <li><input type="checkbox"/> <b>-STN</b> Satin Nickel finish</li> </ul>	<div style="text-align: right;">   </div> <hr/> <p><b>Compliance</b></p> <ul style="list-style-type: none"> <li>-ASME A112.18.1/CSA B125.1</li> <li>-WaterSense 1.5 gpm (5.7 L/min) 2.0 gpm (7.6 L/min)</li> </ul> <div style="text-align: right;">   </div> <hr/> <p><b>Warranty</b></p> <p><b>Limited Lifetime</b> - to the original end purchaser in consumer/residential installations.  <b>5 Years</b> - for industrial/commercial installations.  Refer to <a href="http://www.symmons.com/warranty">www.symmons.com/warranty</a> for complete warranty information.</p>

**Note:** Append appropriate -suffix to model number.

## Dimensions

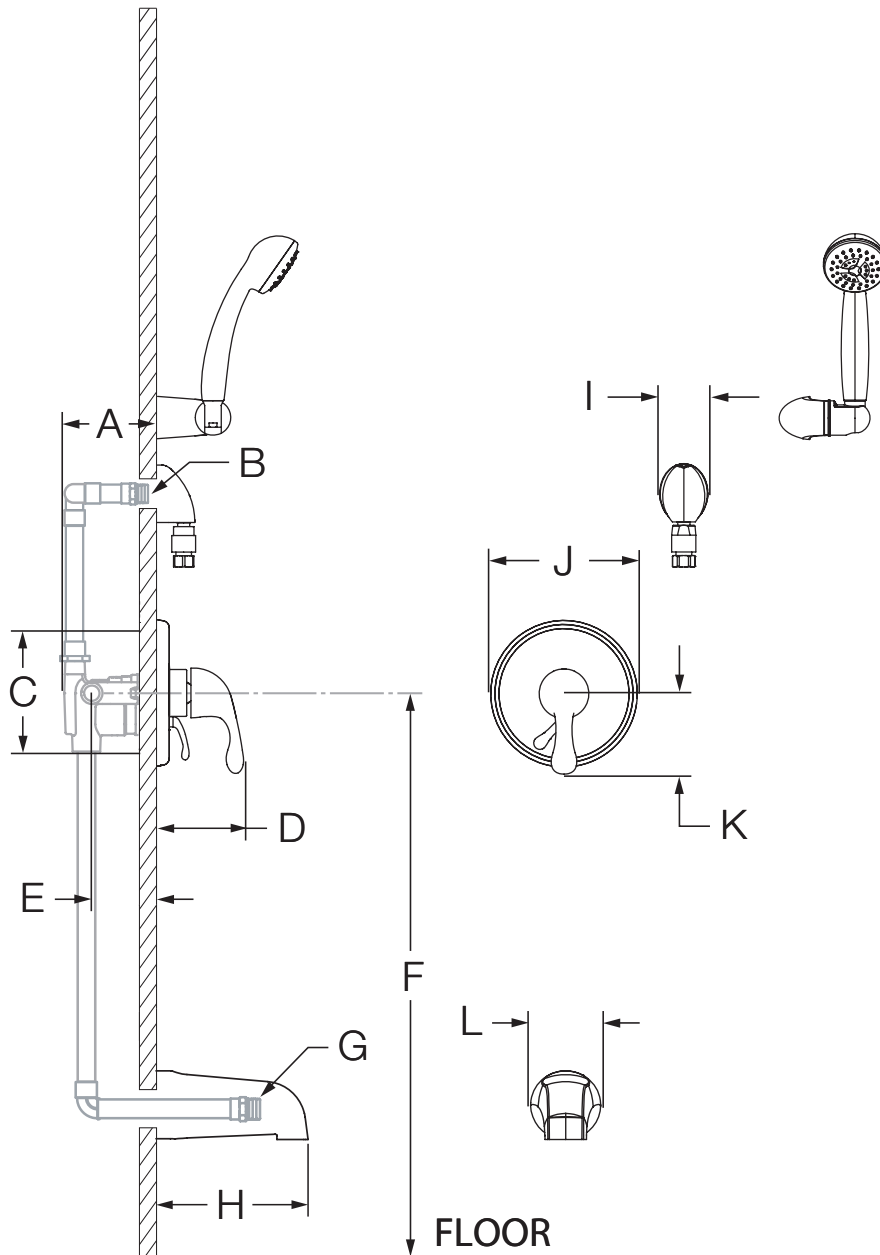

Measurements	
A	3 1/2", 89 mm
B	Male 1/2" NPT fitting must be recessed 1/4" from finished wall
C	Shower Valve Hole Size Min. Ø 3", 76 mm Max. Ø 4", 102 mm
D	3 3/4", 95 mm
E	Rough-in 2 3/8" ± 1/2", 60 mm ± 13 mm
F	Ref. 32", 813 mm
G	Male 1/2" NPT fitting must protrude 4" from finished wall
H	5 1/2", 140 mm
I	2 1/8", 54 mm
J	Ø 6 3/8", 162 mm
K	3 1/2", 89 mm
L	Ø 2 1/2", 64 mm

### Notes:







- 1) All dimensions measured from nominal rough-in (see E as reference).
- 2) Dimensions subject to change without notice.

S-6604

Système de baignoire/douche à main

## Présentation des spécifications



Numéro de modèle	Spécification
<input type="checkbox"/> <b>S-6604</b> <i>Système de baignoire/douche à main Unity</i>	<p>Le système de baignoire/douche à main comprend la vanne à pression autorégularisée Temptrol<sup>®</sup>. Figurer la vis d'arrêt réglable pour limiter le tournage de la poignée, inverseur intégré, un support de douche à main, un bec de baignoire non-déviateur, un reniflard de ligne, 60 po tuyau flexible en métal et 1 douche à main avec un réducteur de débit régulier de 2,5 gpm (9,5 L/min). Les composants sont faits de matériaux métalliques et non métalliques au fini chrome poli standard.</p> <div style="text-align: right;">   </div>
<p><b>Modifications</b></p>	
<input type="checkbox"/> <b>-1.5</b>  Régulateur de débit de 1,5 gpm (5,7 L/min)	<p><b>Conforme</b></p> <p>-ASME A112.18.1/CSA B125.1 -WaterSense 1.5 gpm (5.7 L/min) 2.0 gpm (7.6 L/min)</p> <div style="text-align: right;">   </div>
<input type="checkbox"/> <b>-2.0</b>  Régulateur de débit de 2,0 gpm (7,6 L/min)	
<input type="checkbox"/> <b>-SS</b> <i>Bec de baignoire à enfiler unité baignoire-douche</i>	<p><b>Garantie</b></p> <p><b>À vie limitée</b> - à l'acheteur original dans les installations du consommateur ou résidentielles. <b>5 ans</b> - pour des installations commerciales et industrielles. Se reporter au site <a href="http://www.symmons.com/warranty">www.symmons.com/warranty</a> (en anglais) pour l'information complète concernant la garantie.</p>
<input type="checkbox"/> <b>-X</b> <i>Robinet d'interruption du service</i>	
<input type="checkbox"/> <b>-CHKS</b> <i>Valve d'arrêt intégrée</i>	
<input type="checkbox"/> <b>-IPS</b> <i>Raccords IPS femelles de 1/2 po</i>	
<input type="checkbox"/> <b>-REV</b> <i>Corps central inversé our installations dos à dos</i>	
<input type="checkbox"/> <b>-LP</b> <i>Poignée en boucle</i>	
<input type="checkbox"/> <b>-QD</b> <i>Débranchement rapide pour de douche à main</i>	
<input type="checkbox"/> <b>-R</b> <i>Tuyau de vinyle blanc</i>	
<input type="checkbox"/> <b>-OP</b> <i>Assiette ovale 13 po</i>	
<input type="checkbox"/> <b>-72</b> <i>Tuyau de 6' au lieu de 5' standard</i>	
<input type="checkbox"/> <b>-TRM</b> <i>Garniture seulement, vanne non incluse</i>	
<input type="checkbox"/> <b>-STN</b> <i>Fini nickel satiné</i>	

**Remarque:** Juxtaposer le -suffixe approprié au numéro de modèle.

## Dimensions

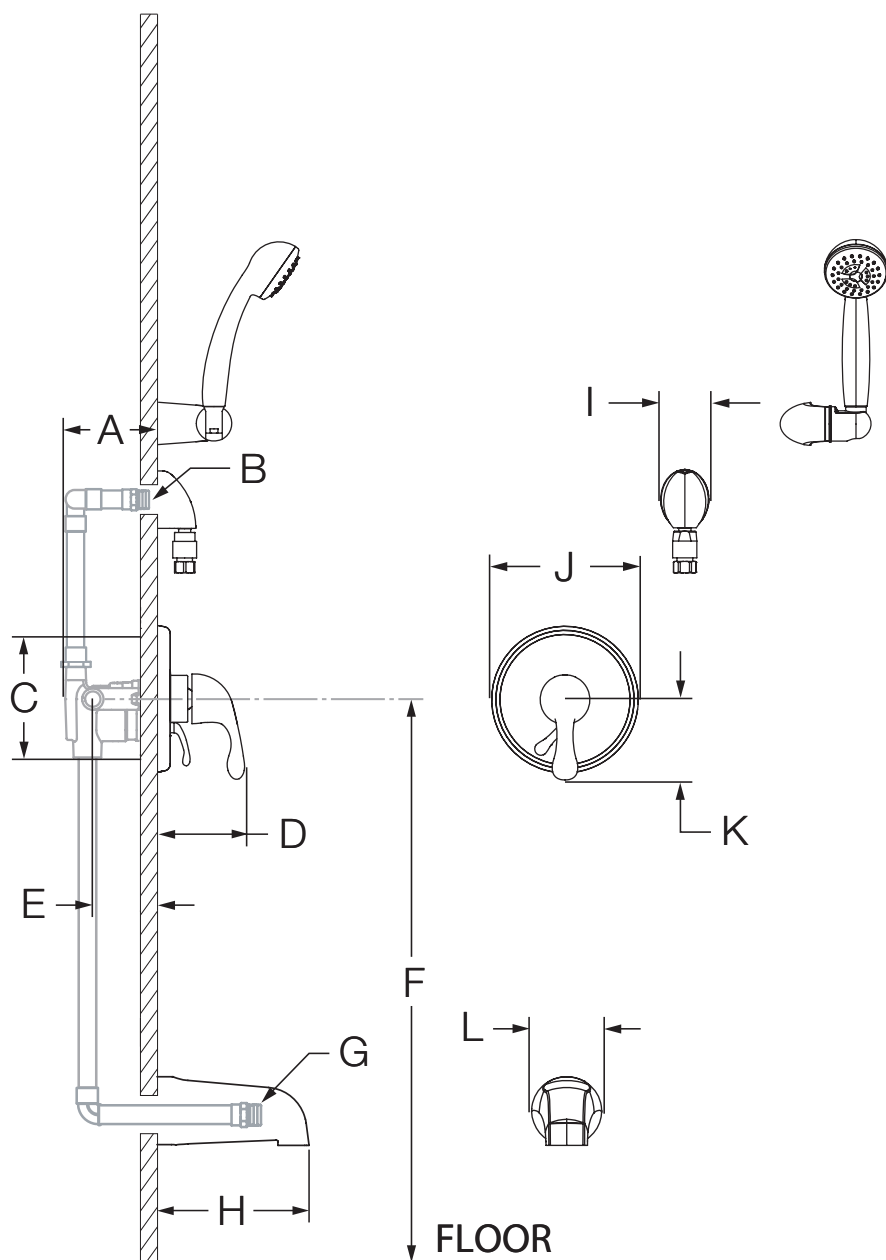

Mesures	
A	3 1/2 po, 89 mm
B	1/2 po mâle à filets NPT doit faire encastré de 1/4 po du mur fini
C	Taille du trou Min. Ø 3 po, 76 mm Max. Ø 4 po, 102 mm
D	3 3/4 po, 95 mm
E	Robinetterie brute 2 3/8 po ± 1/2 po, 60 mm ± 13 mm
F	Réf. 32 po, 813 mm
G	1/2 po mâle à filets NPT doit faire saillie de 4 po du mur fini
H	5 1/2 po, 140 mm
I	2 1/8 po, 54 mm
J	Ø 6 3/8 po, 162 mm
K	3 1/2 po, 89 mm
L	Ø 2 1/2 po, 64 mm

### Remarques:

- 1) Toutes les dimensions sont mesurées à partir de la robinetterie brute nominale (voir F en référence).
- 2) Les dimensions sont sujettes à changer sans préavis.