







Location:



Unity™

S-6603
Hand Shower System
Specification Submittal



Model Numbers	Specification
<p><input type="checkbox"/> S-6603 <i>Unity Hand Shower System</i></p>	<p>Hand shower system powered by the Temptrol® Pressure Balancing valve. Features integrated volume control, wall cradle, in-line vacuum breaker, 60" flexible metal hose, hand shower and standard 2.5 gpm (9.5 L/min) flow restrictor. Components made from metal and nonmetallic materials plated in standard polished chrome finish.</p>
<p>Modifications</p> <ul style="list-style-type: none"> <input type="checkbox"/> -1.5  1.5 gpm (5.7 L/min) flow restrictor <input type="checkbox"/> -2.0  2.0 gpm (7.6 L/min) flow restrictor <input type="checkbox"/> -X <i>Integral service stops</i> <input type="checkbox"/> -CHKS <i>Integral check stops</i> <input type="checkbox"/> -IPS <i>1/2" female IPS connections</i> <input type="checkbox"/> -REV <i>Reverse coring for back to back installations</i> <input type="checkbox"/> -LP <i>Loop handle</i> <input type="checkbox"/> -QD <i>Quick disconnect on hand shower units</i> <input type="checkbox"/> -R <i>White vinyl hose in place of metal hose</i> <input type="checkbox"/> -OP <i>13" oval plate</i> <input type="checkbox"/> -72 <i>6' hose in place of 5' standard</i> <input type="checkbox"/> -TRM <i>Trim only, valve not included</i> <input type="checkbox"/> -STN <i>Satin Nickel finish</i> 	<div style="text-align: right;">   </div> <hr/> <p>Compliance</p> <ul style="list-style-type: none"> -ASME A112.18.1/CSA B125.1 -WaterSense 1.5 gpm (5.7 L/min) 2.0 gpm (7.6 L/min) <p>(Compliance pending)</p> <div style="text-align: right;">   </div> <hr/> <p>Warranty</p> <p>Limited Lifetime - to the original end purchaser in consumer/residential installations. 5 Years - for industrial/commercial installations. Refer to www.symmons.com/warranty for complete warranty information.</p>

Note: Append appropriate -suffix to model number.

Dimensions

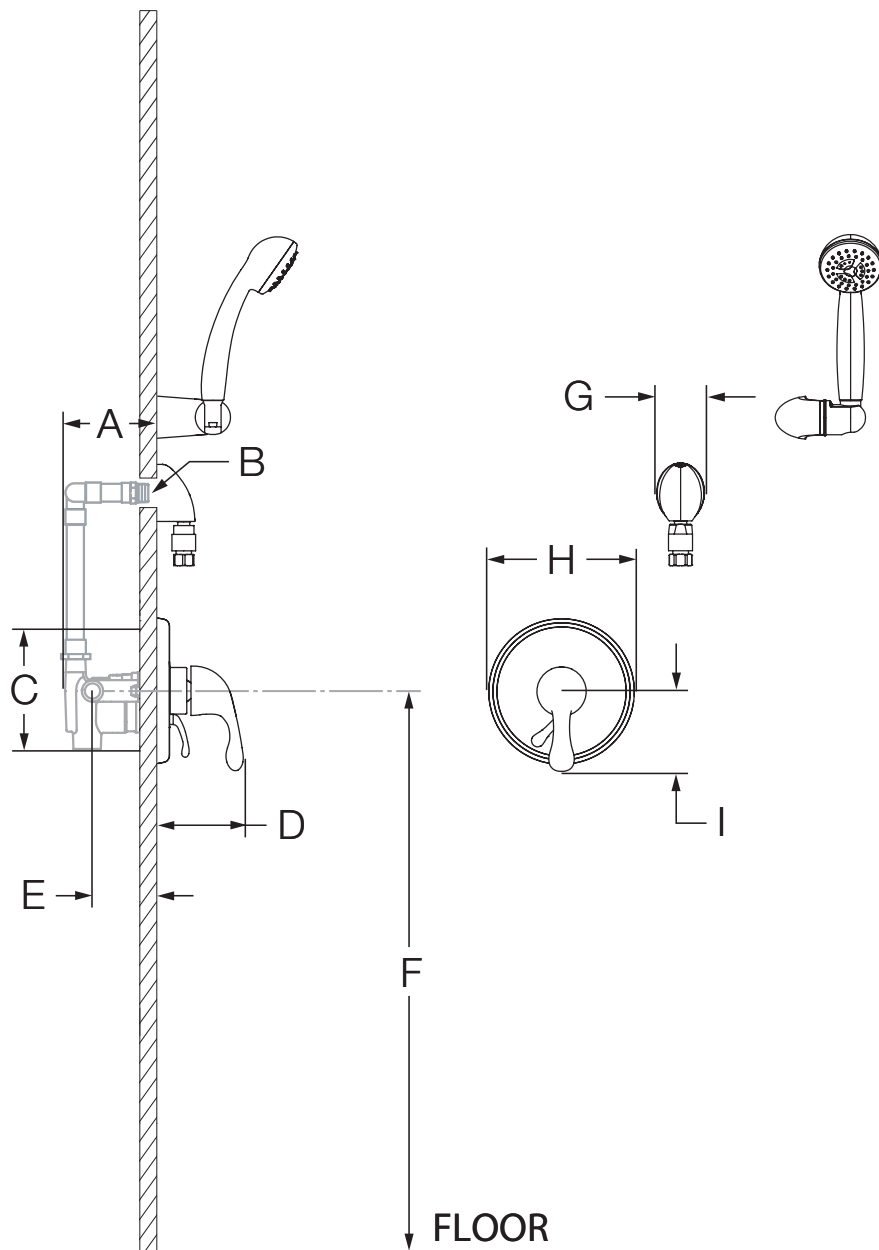

Measurements	
A	3 1/2", 89 mm
B	Male 1/2" NPT fitting must be recessed 1/4" from finished wall
C	Shower Valve Hole Size Min. Ø 3", 76 mm Max. Ø 4", 102 mm
D	3 3/4", 95 mm
E	Rough-in 2 3/8" ± 1/2", 60 mm ± 13 mm
F	Ref. 42", 1067 mm
G	2 1/8", 54 mm
H	Ø 6 3/8", 162 mm
I	3 1/2", 89 mm

Notes:







- 1) All dimensions measured from nominal rough-in (see E as reference).
- 2) Dimensions subject to change without notice.

S-6603

Système douche à main

Présentation des spécifications



Numéro de modèle	Spécification
<input type="checkbox"/> S-6603 <i>Système douche à main Unity</i>	<p>Le système de douche à main comprend la vanne à pression autorégularisée Temptrol[®]. Figurer contrôle du volume integer, une support de douche à main, 60 po tuyau flexible en métal et 1 douche à main avec un réducteur de débit régulier de 2,5 gpm (9,5 L/min). Les composants sont faits de matériaux métalliques et non métalliques au fini chrome poli standard.</p> <div style="text-align: right;">   </div>
<p>Modifications</p>	<p>Conforme</p>
<ul style="list-style-type: none"> <input type="checkbox"/> -1.5  Régulateur de débit de 1,5 gpm (5,7 L/min) <input type="checkbox"/> -2.0  Régulateur de débit de 2,0 gpm (7,6 L/min) <input type="checkbox"/> -X Robinet d'interruption du service <input type="checkbox"/> -CHKS Valve d'arrêt intégrée <input type="checkbox"/> -IPS Raccords IPS femelles de 1/2 po <input type="checkbox"/> -REV Corps central inversé our installations dos à dos <input type="checkbox"/> -LP Poignée en boucle <input type="checkbox"/> -QD Débranchement rapide pour de douche à main <input type="checkbox"/> -R Tuyau de vinyle blanc <input type="checkbox"/> -OP Assiette ovale 13 po <input type="checkbox"/> -72 Tuyau de 6' au lieu de 5' standard <input type="checkbox"/> -TRM Garniture seulement, vanne non incluse <input type="checkbox"/> -STN Fini nickel satiné 	<ul style="list-style-type: none"> -ASME A112.18.1/CSA B125.1 -WaterSense 1.5 gpm (5.7 L/min) 2.0 gpm (7.6 L/min) <p>(Conformité en attendant)</p> <div style="text-align: right;">   </div>
<p>Remarque: Juxtaposer le -suffixe approprié au numéro de modèle.</p>	<p>Garantie</p> <p>À vie limitée - à l'acheteur original dans les installations du consommateur ou résidentielles. 5 ans - pour des installations commerciales et industrielles. Se reporter au site www.symmons.com/warranty (en anglais) pour l'information complète concernant la garantie.</p>

Dimensions

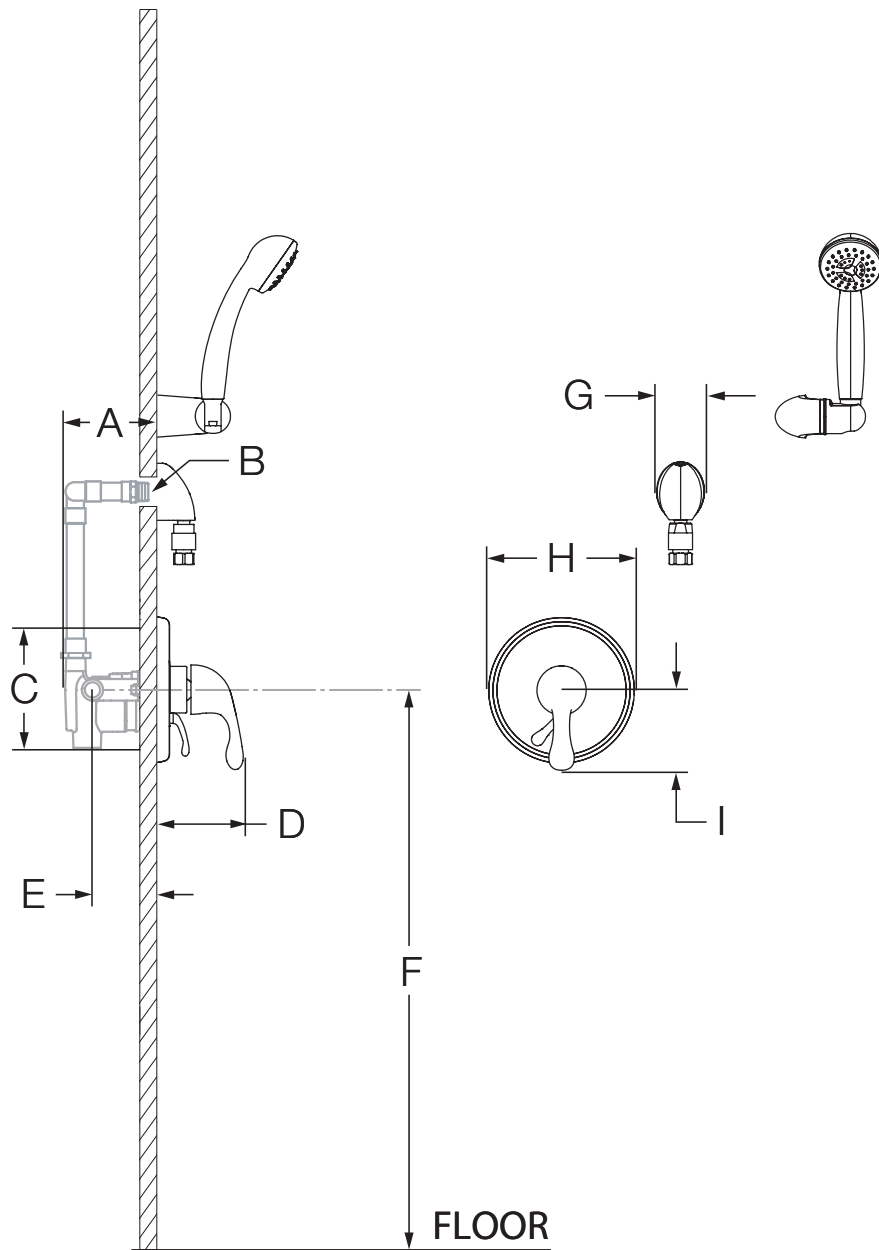

Mesures	
A	3 1/2 po, 89 mm
B	1/2 po mâle à filets NPT doit faire encastré de 1/4 po du mur fini
C	Taille du trou Min. Ø 3 po, 76 mm Max. Ø 4 po, 102 mm
D	3 3/4 po, 95 mm
E	Robinetterie brute 2 3/8 po ± 1/2 po, 60 mm ± 13 mm
F	Réf. 42 po, 1067 mm
G	2 1/8 po, 54 mm
H	Ø 6 3/8 po, 162 mm
I	3 1/2 po, 89 mm

Remarques:

- 1) Toutes les dimensions sont mesurées à partir de la robinetterie brute nominale (voir E en référence).
- 2) Les dimensions sont sujettes à changer sans préavis.