









Location:



S-6602
Tub/Shower System
Specification Submittal

Model Numbers	Specification
<input type="checkbox"/> S-6602 <i>Unity Tub/Shower System</i>	<p>Tub/shower system powered by the Temptrol® Pressure Balancing valve. Features integrated diverter, non-diverter tub spout, 1 mode showerhead with easy to clean rubber nozzles and standard 2.5 gpm (9.5 L/min) flow restrictor. Components made from metal and nonmetallic materials plated in standard polished chrome finish.</p> <div style="text-align: right;">   </div>
<p>Modifications</p> <ul style="list-style-type: none"> <input type="checkbox"/> -1.5  1.5 gpm (5.7 L/min) flow restrictor <input type="checkbox"/> -2.0  2.0 gpm (7.6 L/min) flow restrictor <input type="checkbox"/> -143 Euro-Flo three mode showerhead in place of Clear-Flo <input type="checkbox"/> -145 Euro-Flo five mode showerhead in place of Clear-Flo <input type="checkbox"/> -231 Super showerhead in place of Clear-Flo <input type="checkbox"/> -SS Slip spout on any tub/shower unit <input type="checkbox"/> -X Integral service stops <input type="checkbox"/> -CHKS Integral check stops <input type="checkbox"/> -IPS 1/2" female IPS connections <input type="checkbox"/> -REV Reverse coring for back to back installations <input type="checkbox"/> -LP Loop handle <input type="checkbox"/> -OP 13" oval plate <input type="checkbox"/> -L/HD Less showerhead <input type="checkbox"/> -TRM Trim only, valve not included <input type="checkbox"/> -STN Satin Nickel finish 	
<p>Note: Append appropriate -suffix to model number.</p>	<p>Compliance</p> <ul style="list-style-type: none"> -ASME A112.18.1/CSA B125.1 -WaterSense 1.5 gpm (5.7 L/min) 2.0 gpm (7.6 L/min) <p>(Compliance pending)</p> <div style="text-align: right;">   </div>
	<p>Warranty</p> <p>Limited Lifetime - to the original end purchaser in consumer/residential installations. 5 Years - for industrial/commercial installations. Refer to www.symmons.com/warranty for complete warranty information.</p>

Dimensions

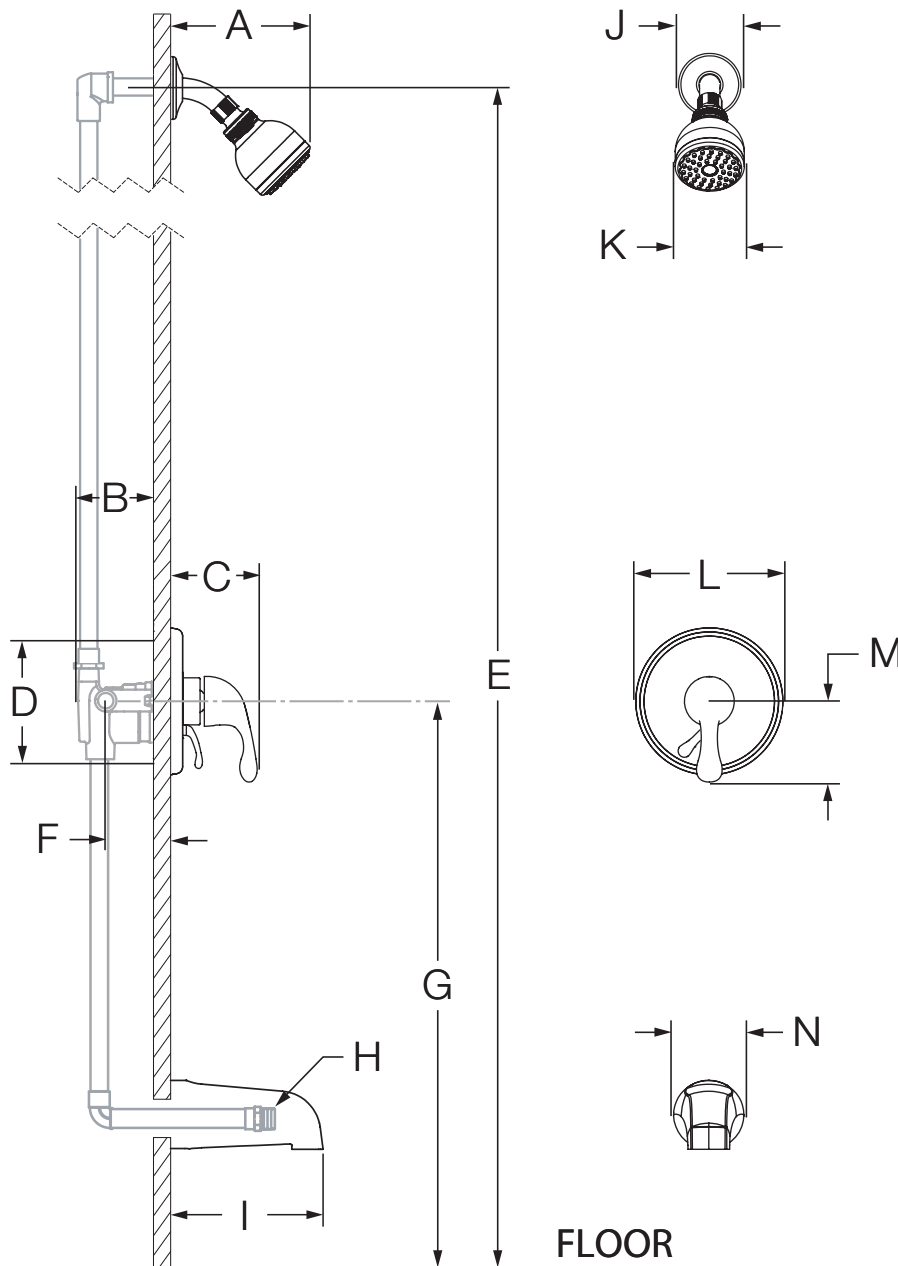

Measurements	
A	6 3/8", 162 mm
B	3 1/2", 89 mm
C	3 3/4", 95 mm
D	Shower Valve Hole Size Min. Ø 3", 76 mm Max. Ø 4", 102 mm
E	Ref. 77", 1956 mm
F	Rough-in 2 3/8" ± 1/2", 60 mm ± 13 mm
G	Ref. 32", 813 mm
H	Male 1/2" NPT fitting must protrude 4" from finished wall
I	5 1/2", 140 mm
J	Ø 2 1/2", 64 mm
K	Ø 2 3/4", 70 mm
L	Ø 6 3/8", 162 mm
M	3 1/2", 89 mm
N	Ø 2 1/2", 64 mm

Notes:







- 1) All dimensions measured from nominal rough-in (see F as reference).
- 2) Dimensions subject to change without notice.

S-6602

Système de baignoire-douche

Présentation des spécifications



Numéro de modèle	Spécification
<input type="checkbox"/> S-6602 <i>Système de baignoire-douche Unity</i>	<p>Le système de baignoire-douche comprend la vanne à pression autorégularisée Temptrol[®]. Figurer un bec de baignoire non-déviateur, 1 pomme de douche avec facile à nettoyer les buses en caoutchouc et réducteur de débit régulier de 2,5 gpm (9,5 L/min). Les composants sont faits de matériaux métalliques et non métalliques au fini chrome poli standard.</p> <div style="text-align: right;">   </div>
<p>Modifications</p>	<p>Conforme</p>
<ul style="list-style-type: none"> <input type="checkbox"/> -1.5  Régulateur de débit de 1,5 gpm (5,7 L/min) <input type="checkbox"/> -2.0  Régulateur de débit de 2,0 gpm (7,6 L/min) <input type="checkbox"/> -143 <i>Pomme de douche Euro-Flo de trois mode à la place de Clear-Flo</i> <input type="checkbox"/> -145 <i>Pomme de douche Euro-Flo de cinq mode à la place de Clear-Flo</i> <input type="checkbox"/> -231 <i>Super pomme de douche au lieu du Clear-Flo</i> <input type="checkbox"/> -SS <i>Bec de baignoire à enfiler unité baignoire-douche</i> <input type="checkbox"/> -X <i>Robinet d'interruption du service</i> <input type="checkbox"/> -CHKS <i>Valve d'arrêt intégrée</i> <input type="checkbox"/> -IPS <i>Raccords IPS femelles de 1/2 po</i> <input type="checkbox"/> -REV <i>Corps central inversé our installations dos à dos</i> <input type="checkbox"/> -LP <i>Poignée en boucle</i> <input type="checkbox"/> -OP <i>Assiette ovale 13 po</i> <input type="checkbox"/> -L/HD <i>Sans pomme de douche</i> <input type="checkbox"/> -TRM <i>Garniture seulement, vanne non incluse</i> <input type="checkbox"/> -STN <i>Fini nickel satiné</i> 	<p>-ASME A112.18.1/CSA B125.1 -WaterSense 1.5 gpm (5.7 L/min) 2.0 gpm (7.6 L/min) (Conformité en attendant)</p> <div style="text-align: right;">   </div>
	<p>Garantie</p>
<p>Remarque: Juxtaposer le -suffixe approprié au numéro de modèle.</p>	<p>À vie limitée - à l'acheteur original dans les installations du consommateur ou résidentielles. 5 ans - pour des installations commerciales et industrielles. Se reporter au site www.symmons.com/warranty (en anglais) pour l'information complète concernant la garantie.</p>

Dimensions

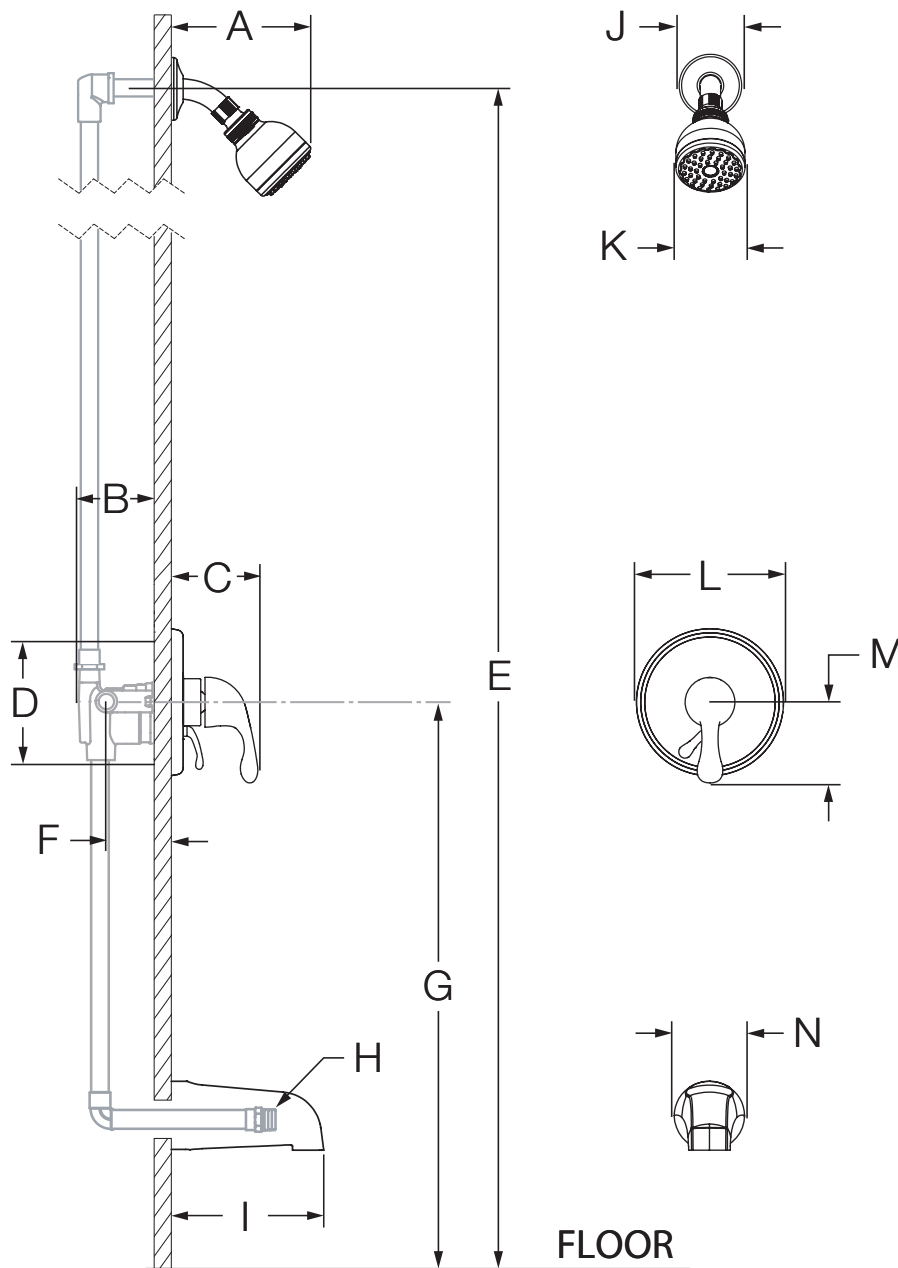

Mesures	
A	6 3/8 po, 162 mm
B	3 1/2 po, 89 mm
C	3 3/4 po, 95 mm
D	Taille du trou Min. Ø 3 po, 76 mm Max. Ø 4 po, 102 mm
E	Réf. 77 po, 1956 mm
F	Robinetterie brute 2 3/8 po ± 1/2 po, 60 mm ± 13 mm
G	Réf. 32 po, 813 mm
H	1/2 po mâle à filets NPT doit faire saillie de 4 po du mur fini
I	5 1/2 po, 140 mm
J	Ø 2 1/2 po, 64 mm
K	Ø 2 3/4 po, 70 mm
L	Ø 6 3/8 po, 162 mm
M	3 1/2 po, 89 mm
N	Ø 2 1/2 po, 64 mm

Remarques:

- 1) Toutes les dimensions sont mesurées à partir de la robinetterie brute nominale (voir F en référence).
- 2) Les dimensions sont sujettes à changer sans préavis.