









9603-PLR  
Hand Shower System  
**Specification Submittal**

Specification	Modifications
<p>Hand shower system powered by the Temptrol® Pressure Balancing valve. Hand shower system shall include adjustable stop screw to limit handle turn, 36" slide bar, in-line vacuum breaker, 60" flexible metal hose, ADA hand shower and standard 2.5 gpm (9.5 L/min) flow restrictor. Components shall be made from metal and nonmetallic construction, plated in standard polished chrome finish.</p> <div style="text-align: right;">   </div>	<ul style="list-style-type: none"> <li><input type="checkbox"/> <b>CG</b> -1.5 1.5 gpm (5.7 L/min) flow restrictor</li> <li><input type="checkbox"/> -2.0 2.0 gpm (7.6 L/min) flow restrictor</li> <li><input type="checkbox"/> -72 72" hose in place of 60" hose</li> <li><input type="checkbox"/> -ADAHS ADA hand shower wand (white)</li> <li><input type="checkbox"/> -B Brass escutcheon (chrome only)</li> <li><input type="checkbox"/> -CHKS Integral check stops - for use in installations where a positive shut-off device is used downstream of mixing valve</li> <li><input type="checkbox"/> -D Brass dome cover (chrome only)</li> <li><input type="checkbox"/> -H321-V 1 mode hand shower unit with slide bar in place of standard hand shower unit</li> <li><input type="checkbox"/> -H323-V 3 mode hand shower unit with slide bar in place of standard hand shower unit</li> <li><input type="checkbox"/> -IPS 1/2" female IPS connections</li> <li><input type="checkbox"/>  -LAM Lever handle</li> <li><input type="checkbox"/>  -LP Loop handle</li> <li><input type="checkbox"/> -L/HS Less hand shower</li> <li><input type="checkbox"/> -OP 13" oval plate (PLR only)</li> <li><input type="checkbox"/> -QD Quick-disconnect on hand spray units</li> <li><input type="checkbox"/> -R 60" white vinyl hose in place of 60" metal hose</li> <li><input type="checkbox"/> -REB Rebuild trim kit, includes TA-10 and TA-4</li> <li><input type="checkbox"/> -REV Reverse coring, hot on right, cold on left, for back to back installations</li> <li><input type="checkbox"/> -T724 24" slide bar/grab bar with ADA hand shower in place of standard hand shower unit</li> <li><input type="checkbox"/> -T748 48" slide bar/grab bar with ADA hand shower in place of standard hand shower unit</li> <li><input type="checkbox"/> -VB Elevated vacuum breaker</li> <li><input type="checkbox"/> -VP Vandal resistant escutcheon screws in place of standard screws</li> <li><input type="checkbox"/> -X Integral service stops - allows water shutoff at valve for service</li> </ul> <p><b>Note:</b> Append appropriate -suffix to model number.</p>
<p><b>Model Numbers</b></p>	
<ul style="list-style-type: none"> <li><input type="checkbox"/> <b>9603-PLR</b> <i>Origins hand shower system</i></li> <li><input type="checkbox"/> <b>9603-PLR-TRM</b> <i>Origins hand shower, trim only</i></li> <li><input type="checkbox"/> <b>46-2-BODY</b> <i>Temptrol Pressure Balancing tub/shower valve body</i></li> <li><input type="checkbox"/> <b>46-2X-BODY</b> <i>Temptrol Pressure Balancing tub/shower valve body with stops</i></li> </ul>	
<p><b>Finish Options</b></p>	
<ul style="list-style-type: none"> <li><input type="checkbox"/> <b>-STN</b> <i>Satin Nickel finish</i></li> </ul>	
<p><b>Compliance</b></p> <p>-ASME A112.18.1/CSA B125.1 -WaterSense 1.5 gpm (5.7 L/min) 2.0 gpm (7.6 L/min)</p> <div style="text-align: right;">   </div>	
<p><b>Warranty</b></p> <p><b>Limited Lifetime</b> - to the original end purchaser in consumer/residential installations. <b>5 Years</b> - for industrial/commercial installations. Refer to <a href="http://www.symmons.com/warranty">www.symmons.com/warranty</a> for complete warranty information.</p>	

## Dimensions

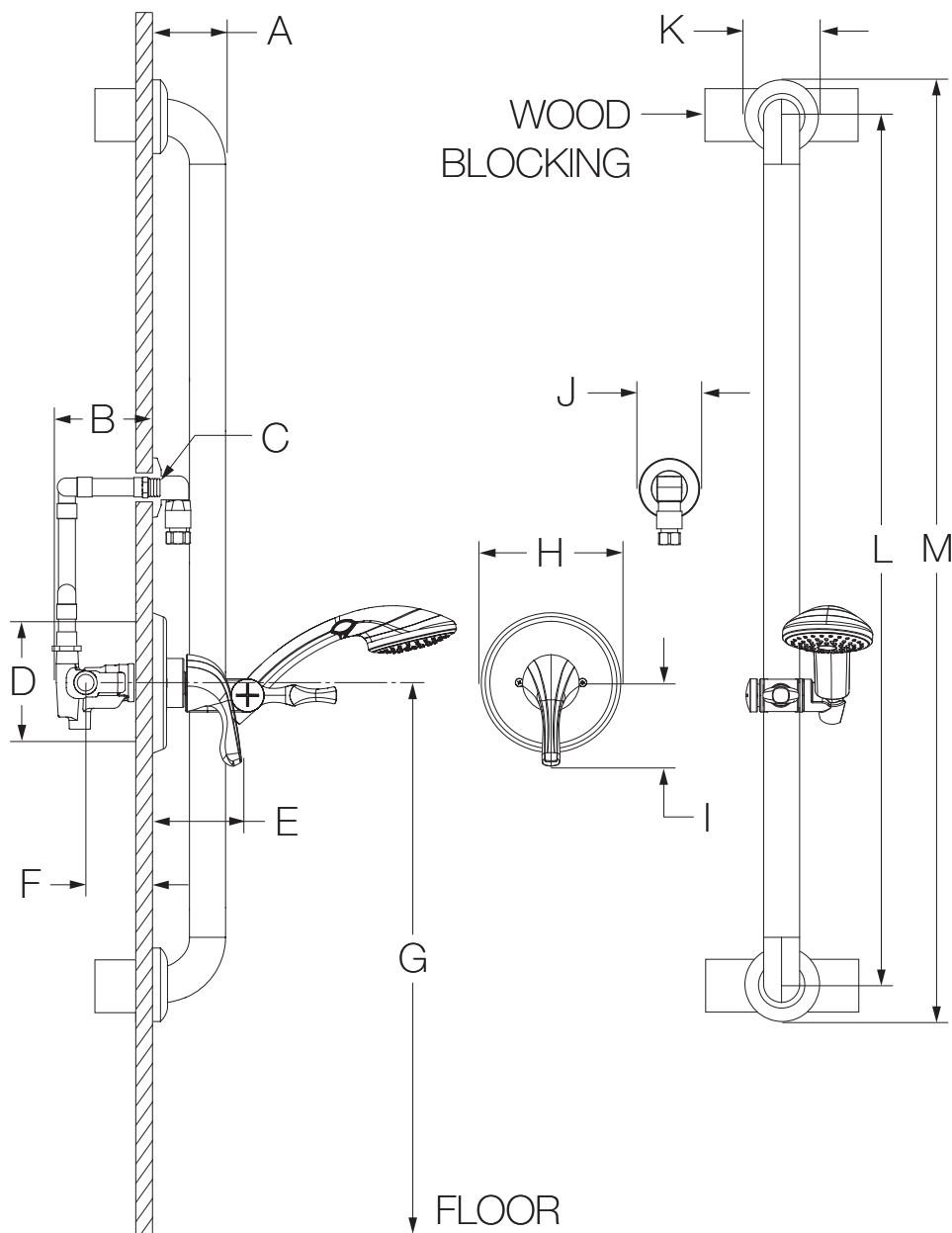

Measurements	
A	3", 76 mm
B	3-1/2", 89 mm
C	Male 1/2" NPT fitting must protrude 3/8" from finished wall
D	Shower Valve Hole Size Min. Ø 3", 76 mm Max. Ø 4", 102 mm
E	3-5/8", 92 mm
F	Rough-in 2-3/8" ± 1/2", 60 mm ± 13 mm
G	Ref. 42", 1067 mm
H	Ø 5-3/4", 146 mm
I	3-3/8", 86 mm
J	Ø 2-1/2", 64 mm
K	Ø 3-1/8", 79 mm
L	36", 914 mm
M	39", 991 mm

### Notes:







- 1) All dimensions measured from nominal rough-in (see F as reference).
- 2) Dimensions subject to change without notice.

9603-PLR

Système douche à main

## Présentation des spécifications



Spécification	Modifications
<p>Le système de douche à main comprend la vanne à pression autorégularisée Temptrol®. Figurer la vis d'arrêt réglable pour limiter le tournage de la poignée, une barre de glissement de 36 po, 60 po tuyau flexible en métal et 1 douche à main avec un réducteur de débit régulier de 2,5 gpm (9,5 L/min). Les composants sont faits de matériaux métalliques et non métalliques au fini chrome poli standard.</p>  	<ul style="list-style-type: none"> <li><input type="checkbox"/> <b>CG</b> -1.5 Régulateur de débit de 1,5 gpm (5,7 L/min)</li> <li><input type="checkbox"/> -2.0 Régulateur de débit de 2,0 gpm (7,6 L/min)</li> <li><input type="checkbox"/> -72 Tuyau de 72 po à la place du tuyau de 60 po</li> <li><input type="checkbox"/> -ADAHS Douche à main ADA (blanc)</li> <li><input type="checkbox"/> -B Vanne de la rosace chrome laiton</li> <li><input type="checkbox"/> -CHKS Valve d'arrêt intégrée</li> <li><input type="checkbox"/> -D Couvercle en dôme chrome laiton</li> <li><input type="checkbox"/> -H321-V Douche à main à 1 mode avec barre coulissante au lieu de l'unité de douche à main standard</li> <li><input type="checkbox"/> -H323-V Douche à main à 3 modes avec barre coulissante au lieu de l'unité de douche à main standard</li> </ul>
<h3>Numéro de modèle</h3> <ul style="list-style-type: none"> <li><input type="checkbox"/> <b>9603-PLR</b> <i>Système de douche à main Origins</i></li> <li><input type="checkbox"/> <b>9603-PLR-TRM</b> <i>Garniture seulement de douche à main Origins</i></li> <li><input type="checkbox"/> <b>46-2-BODY</b> <i>Pression autorégularisée Temptrol</i></li> <li><input type="checkbox"/> <b>46-2X-BODY</b> <i>Pression autorégularisée robinet d'interruption du service Temptrol</i></li> </ul>	<ul style="list-style-type: none"> <li><input type="checkbox"/> -IPS Raccords IPS femelles de 1/2 po</li> <li><input type="checkbox"/>  -LAM Poignée du levier</li> <li><input type="checkbox"/>  -LP Poignée de boucle</li> <li><input type="checkbox"/> -L/HS Sans douche à main</li> <li><input type="checkbox"/> -OP Assiette ovale 13 po</li> <li><input type="checkbox"/> -QD Débranchement rapide pour de douche à main</li> <li><input type="checkbox"/> -R Tuyau de vinyle blanc</li> <li><input type="checkbox"/> -REB L'ensemble de remise en état de la finition, incluant TA-10 et TA-4</li> <li><input type="checkbox"/> -REV Corps central inversé our installations dos à dos</li> <li><input type="checkbox"/> -T724 Barre à glissière de 24 po barre d'appui avec douchette à main ADA</li> <li><input type="checkbox"/> -T748 Barre à glissière de 48 po barre d'appui avec douchette à main ADA</li> </ul>
<h3>Options de finition</h3> <ul style="list-style-type: none"> <li><input type="checkbox"/> <b>-STN</b> <i>Fini nickel satiné</i></li> </ul>	<ul style="list-style-type: none"> <li><input type="checkbox"/> -T724 Barre à glissière de 24 po barre d'appui avec douchette à main ADA</li> <li><input type="checkbox"/> -T748 Barre à glissière de 48 po barre d'appui avec douchette à main ADA</li> </ul>
<h3>Conforme</h3> <ul style="list-style-type: none"> <li>-ASME A112.18.1/CSA B125.1</li> <li>-WaterSense 1.5 gpm (5.7 L/min) 2.0 gpm (7.6 L/min)</li> </ul>  	<ul style="list-style-type: none"> <li><input type="checkbox"/> -VB Reniflard surélevé</li> <li><input type="checkbox"/> -VP Des vis anti-vandalisme de la rosace remplacent les vis régulières</li> <li><input type="checkbox"/> -X Robinet d'interruption du service</li> </ul>
<h3>Garantie</h3> <p><b>À vie limitée</b> - à l'acheteur original dans les installations du consommateur ou résidentielles.</p> <p><b>5 ans</b> - pour des installations commerciales et industrielles. Se reporter au site <a href="http://www.symmons.com/warranty">www.symmons.com/warranty</a> (en anglais) pour l'information complète concernant la garantie.</p>	<p><b>Remarque:</b> Juxtaposer le -suffixe approprié au numéro de modèle.</p>

## Dimensions

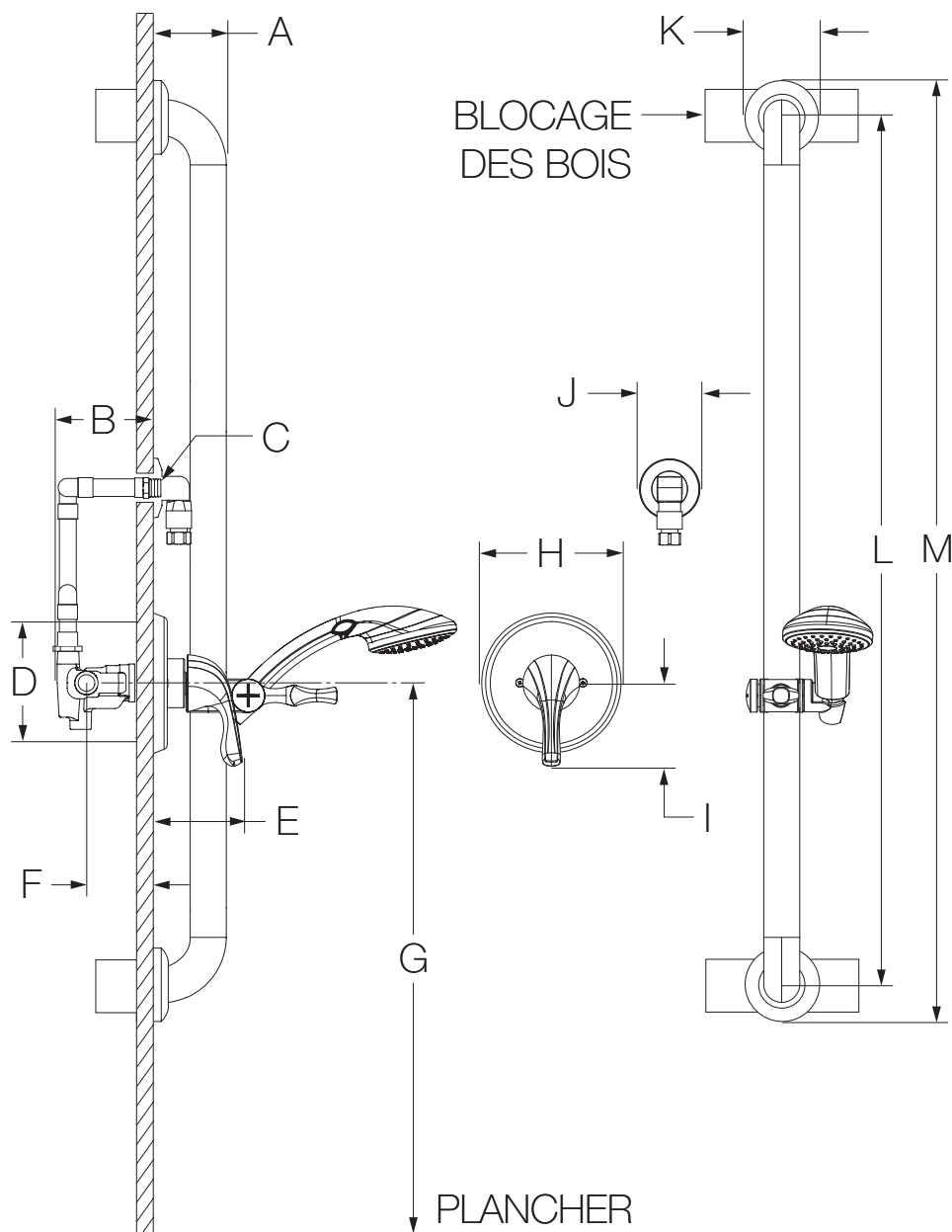

Mesures	
A	3 po, 76 mm
B	3-1/2 po, 89 mm
C	1/2 po mâle à filets NPT doit faire saillie de 3/8 po du mur fini
D	Taille du trou Min. Ø 3 po, 76 mm Max. Ø 4 po, 102 mm
E	3-5/8 po, 92 mm
F	Robinetterie brute 2-3/8 po ± 1/2 po, 60 mm ± 13 mm
G	Réf. 42 po, 1067 mm
H	Ø 5-3/4 po, 146 mm
I	3-3/8 po, 86 mm
J	Ø 2-1/2 po, 64 mm
K	Ø 3-1/8 po, 79 mm
L	36 po, 914 mm
M	39 po, 991 mm

### Remarques:

- 1) Toutes les dimensions sont mesurées à partir de la robinetterie brute nominale (voir F en référence).
- 2) Les dimensions sont sujettes à changer sans préavis.