

# INSTALLATION INSTRUCTIONS

*Swiss Madison*  
well made forever

## Ceramic Undermount Sink

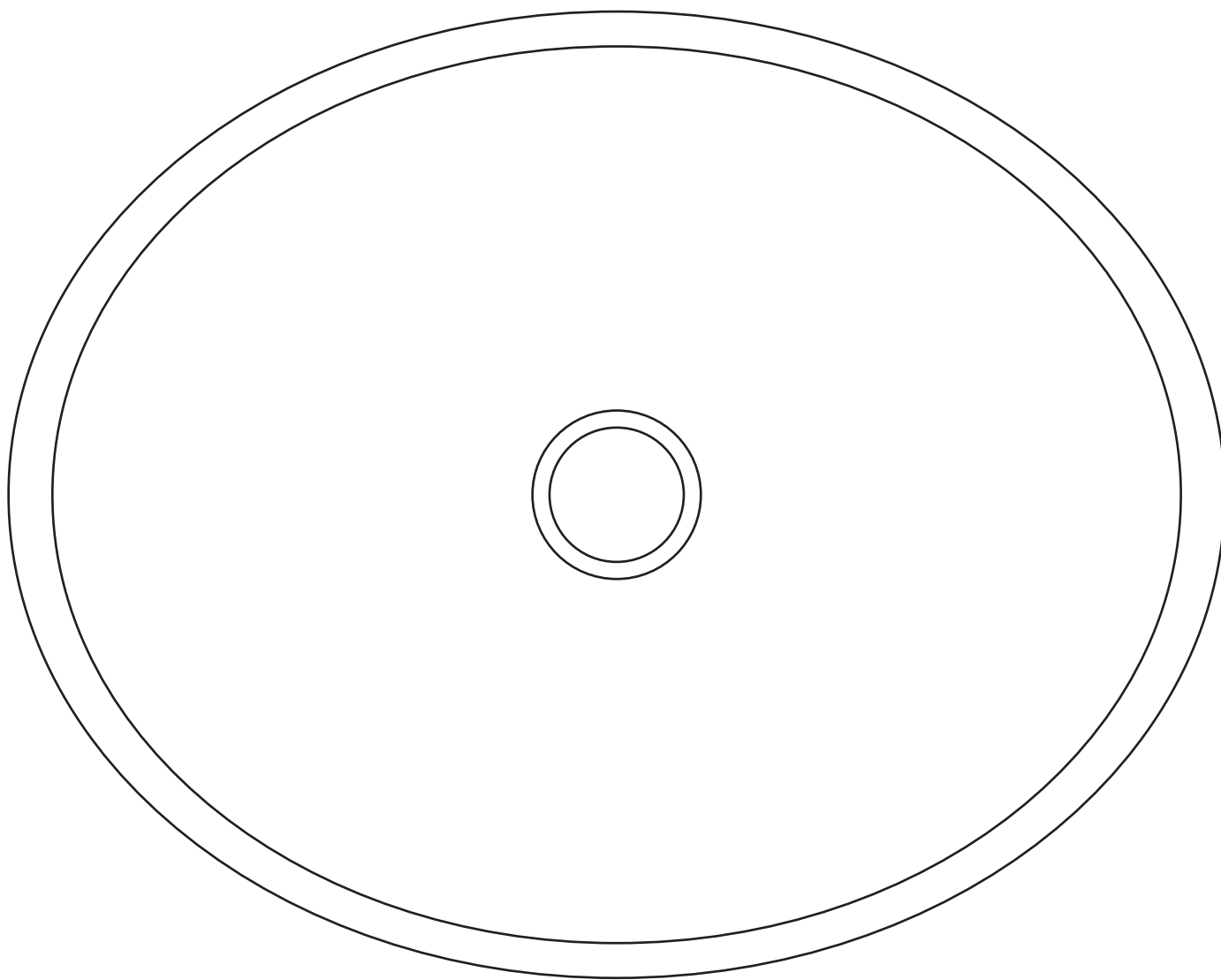

Share your pictures for a feature!  
using **#SwissMadison**





## Prior to Installation:

- Inspect sink to ensure no damages have occurred while in shipping
- If provided, use the Swiss Madison cut out template
- Observe all plumbing and building codes in accordance with your state and local requirements
- Additional floor and wall preparations may be necessary to avoid damage to the product
- Installation with laminate countertop not recommended
- We recommend professional countertop installers. Customer is responsible for damage to countertop and/or sink during installation.

**General Recommendations:** Read installation and maintenance instructions thoroughly before installing the sink. Be sure to use proper tools and always wear proper personal safety accessories for your protection.

**If you have any questions or concerns please contact us:**

1-434-623-4766  
info@swissmadison.com

## **Thank you for your purchase**

Thank you for purchasing a Swiss Madison Ceramic Sink.

We appreciate your business and know you will enjoy your sink for many years to come.

If you have any questions or require assistance we would be happy to help,  
please contact us at 1-434-6234766 or [info@swissmadison.com](mailto:info@swissmadison.com).

To learn more about our products, please visit:

**[www.swissmadison.com](http://www.swissmadison.com)**

*Sincerely,*

*The Swiss Madison Team*

# UNDERMOUNT SINK

# MODELS

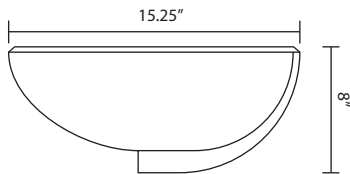
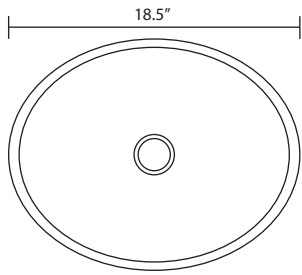

SM-UM621

18.5" x 15.25" x 8"

\*Matching Drain: SM-PD23R

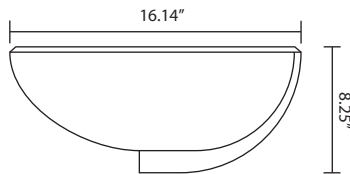
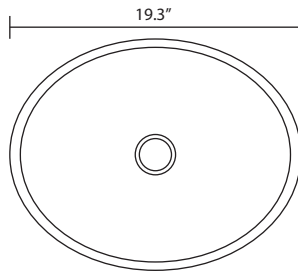

SM-UM622

19.3" x 16.14" x 8.25"

\*Matching Drain: SM-PD23R

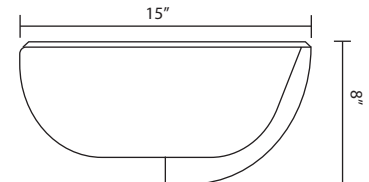
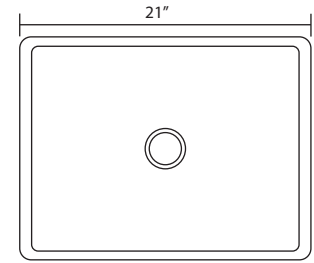

SM-UM623

21" x 15" x 8"

\*Matching Drain: SM-PD23R

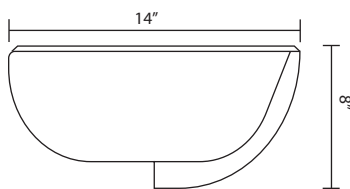
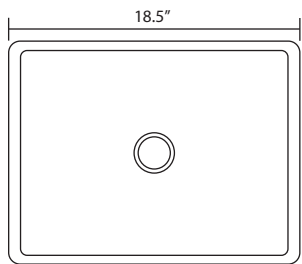

SM-UM624

18.5" x 14" x 8"

\*Matching Drain: SM-PD23R

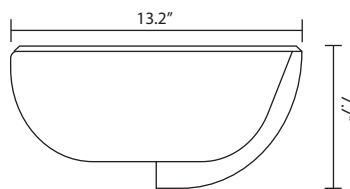
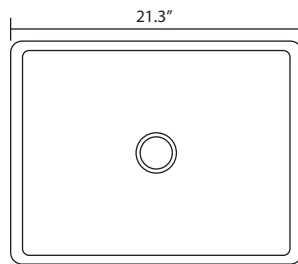

SM-UM625

21.3" x 13.2" x 7.7"

\*Matching Drain: SM-PD23R

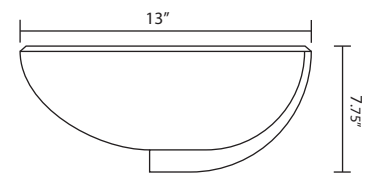
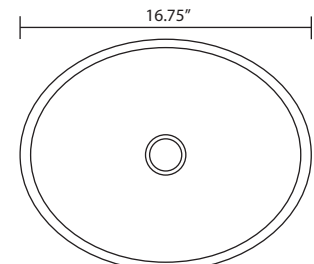

SM-UM629

16.75" x 13" x 7.75"

\*Matching Drain: SM-PD23R

**NOTE:** Not all the styles are the same size or shapes.

**NOTE:** Pictures may not define contour of china and components.

**\*Matching drains are not included, please contact us if you wish to purchase one.**

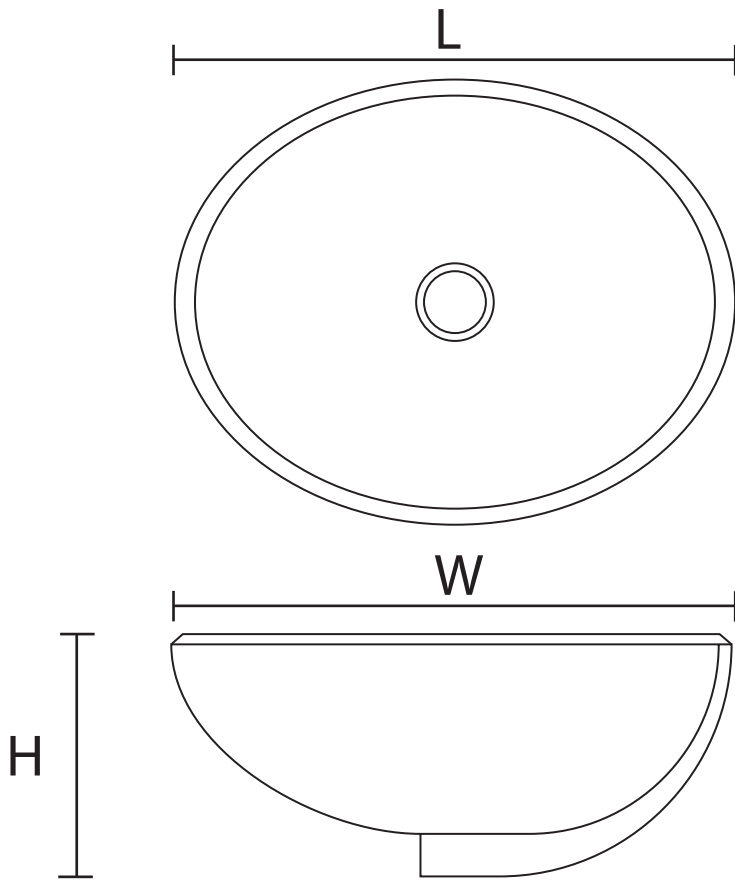

SKU	NAME
SM-UM621	Plasir 18" Oval
SM-UM622	Plasir 19" Oval
SM-UM623	Plasir 21" Rectangular
SM-UM624	Plasir 18" Rectangular
SM-UM625	Voltaire 21" Rectangular
SM-UM629	Plasir 16.5" Oval

## SUGGESTED TOOLS AND MATERIALS



Drill

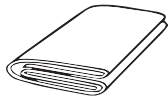

Towel

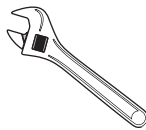

Adjustable Wrenches



Jig Saw/  
Hacksaw



Gloves



Safety Glasses



Pencil

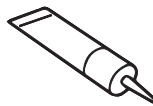

Liquid  
Nail

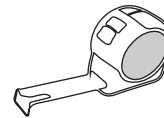

Tape Measure

## PARTS LIST

- Swiss Madison Sink

**NOTE:** Specialized tools may be necessary to install Swiss Madison Ceramic Undermount sinks with countertop materials other than wood, marble, or granite.

The step-by-step guidelines in the installation instructions are a general reference for installing a Swiss Madison Sink. Should there be any discrepancies, Swiss Madison cannot be held liable. It is recommended to install all Swiss Madison products by hiring a licensed professional



1. Read the complete instruction manual before beginning installation.
2. Confirm that your model will fit in intended location and plumbing fixtures are located where legally required before beginning installation.
3. These installation instructions are for solid surface, composite material countertops.
4. Not all drawings on this manual are drawn to scale. Please refer to the model chart.
5. Two people are recommended to install and move this product.

## 1. Determine Reveal Type

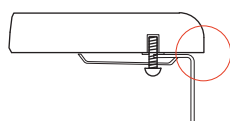

Negative: Counter edge extends past sink rim approximately 1/4" (Figure A)

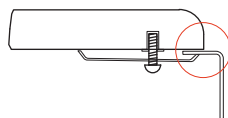

Positive: Sink rim is exposed approximately 1/4" from edge of countertop (Figure B)

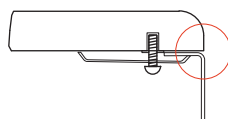

Flush: Sink edge is flush with countertop opening (Figure C)

**NOTE:** This manual instructs specifically for mounting a FLUSH reveal type. Make sure to consult your plumber about desired reveal type PRIOR to installation.

## 2. Clean Countertop

- Make sure to thoroughly clean the underside of the countertop and let it dry completely.

**Note:** The undersides of counters tend to be rough and unfinished which makes it easy to hold debris. You want to make sure it's clean so nothing interferes with the bond between adhesive and the countertop.

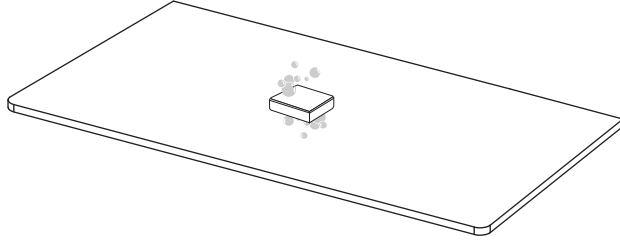

## 3. Position and Trace Sink

- Flip sink upside down on top countertop in the desired location you want the sink to be.
- Trace the outline of the sink onto the countertop.

**Note:** Make sure clearance is suitable for back splash, faucet, and plumbing for the sink.

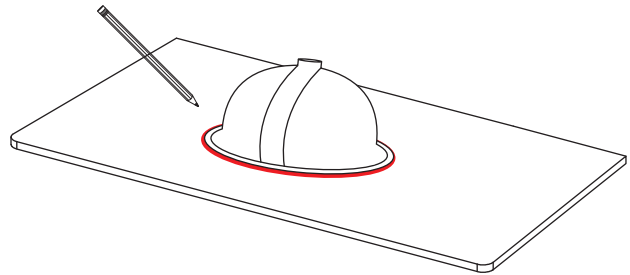
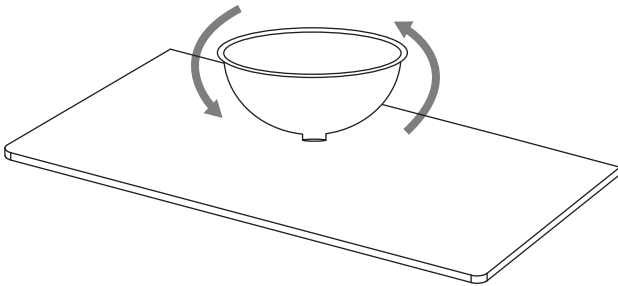

## 4. Cut Countertop

- Cut an opening in the countertop by carefully following the traced line.

### Notes:

- Please use the appropriate saw that best fits your countertop material.
- Professional should be consulted for cutting countertop

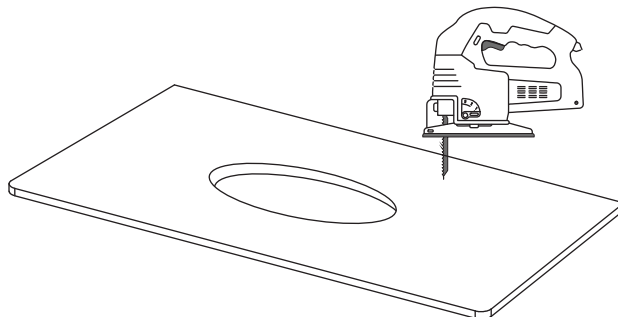

## 5. Secure Sink to Countertop

- Once again clean underside of the countertop and around cut-out area making sure area is free of defects.
- Apply a liquid nail or adhesive of choice to the rim of the sink near the inside edge. Be careful not to miss or skip any area.
- Carefully lift sink squarely under countertop cut-out. Press firmly on sink to form seal and seal sink. Immediately wipe excess sealant with damp cloth. Be careful not to smear or spread sealant onto countertop or sink.

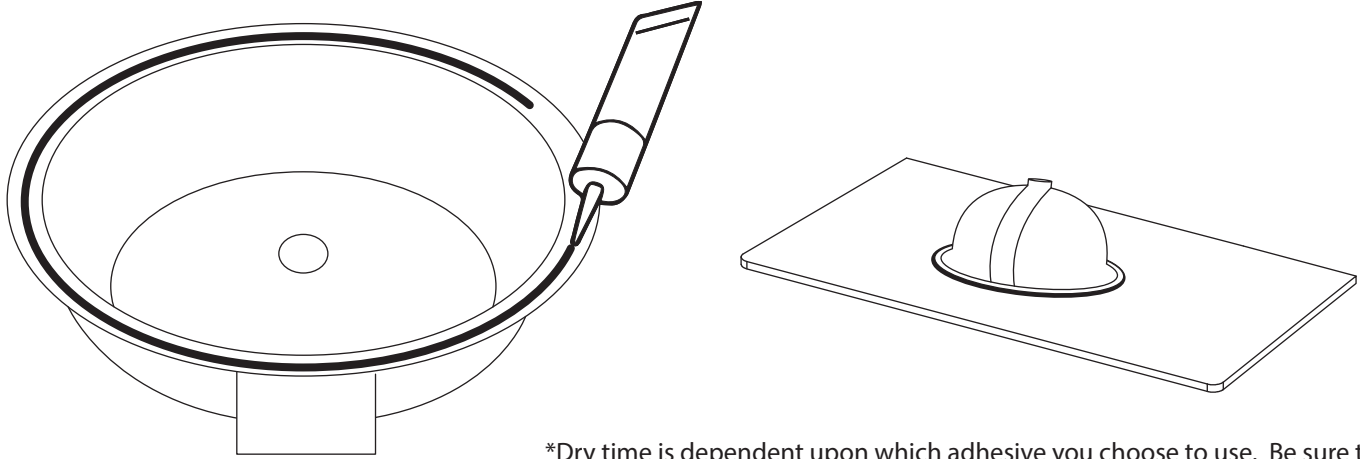

\*Dry time is dependent upon which adhesive you choose to use. Be sure to check your adhesive instructions before use.

## 6. Installing Plumbing Fixtures

- Turn counter back over.
- Connect drain, trap to drain, and water supply connections to faucet according to manufacturer's instruction.
- Test run water into sink and check for leaks.

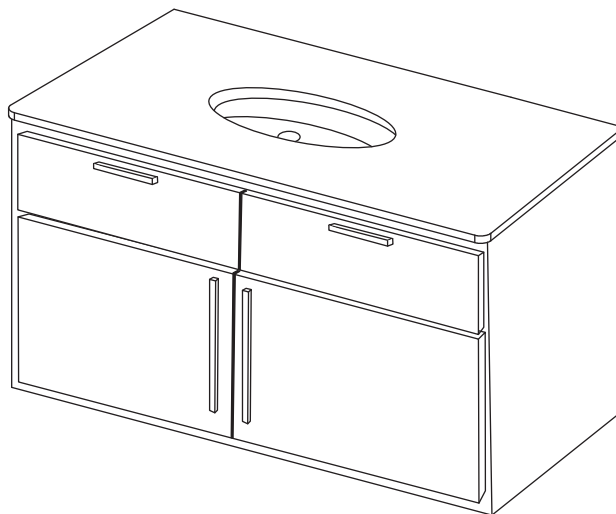





## ONE YEAR LIMITED WARRANTY

1-434-MADISON  
(623-4766)  
19 Stults Rd., Dayton, NJ 08810  
[www.swissmadison.com](http://www.swissmadison.com)

Swiss Madison® products are made with quality materials and excellent craftsmanship to provide the customers a long lasting product. In the case of any defects in materials or craftsmanship under regular use were inspected in the first year of purchase, Swiss Madison® will provide replacement parts at no charge, or at its option, replace any product or part of the product that is deemed defective, under normal installation, use, service and maintenance. This warranty applies only to the original purchaser. Proof of purchase will be required in the case of a claim.

Swiss Madison® recommends the installations to be made by a licensed, professional plumber. Swiss Madison® will not be held responsible for any damage or product failure due to improper installation, misuse, or failure to use a licensed professional. Swiss Madison® is not responsible for any removal or installation cost.

This One Year Limited Warranty will be voided if:

- The installation recommendations were not followed.
- The product has been moved from it's initial place of installation.
- The product has been modified.
- The product has been subjected to improper maintenance, abuse, misuse, excessive use of chemicals, accident or other damages.

Swiss Madison® makes no implication that products comply with any or all local building or plumbing codes. It is the consumer's responsibility to determine local code compliance. This warranty extends to the original purchaser and first consumer.

Swiss Madison® is not liable for any incidental, consequential or special damages associated with the return, replacement, installation or use of your product. This includes freight costs, labor, travel time, lost profit, home damages and other contingent liabilities and costs (including, without limitation, costs associated with experts, investigations, analyses, attorneys and other professionals and services).

The Swiss Madison® warranty is a comprehensive and explicit limit of liability, and all items outside of it are not addressable by or the responsibility of Swiss Madison®. Certain states have variances regarding implied warranties and in those situations we remain fully compliant.

In the case of any questions or a claim contact us directly at 1-434-MADISON (623-4766).

**WARNING:** Content may contain sharp and other possibly harmful pieces and may cause hazard to children and adults, Swiss Madison® is not responsible in any way for personal damage.